



User's Guide

Home Projector

EF-100W Android TV™ edition

EF-100B Android TV™ edition

Notations Used in This Guide	5	Selecting the Language for the Projector Menus	30
<hr/>		Projection Modes	31
Introduction to Your Projector	8	Changing the Projection Mode Using the Menus	31
<hr/>		Adjusting the Image Height	32
Projector Parts and Functions	9	Image Shape	33
Projector Parts - Front/Top	9	Auto V-Keystone	33
Projector Parts - Rear	10	Correcting the Image Shape Horizontally with the Horizontal Keystone Buttons	33
Projector Parts - Base	10	Correcting the Image Shape with the Keystone Button	34
Projector Parts - Control Panel	11	Correcting the Image Shape with Quick Corner	35
Projector Parts - Projector Remote Control	11	Focusing the Image Using the Focus Lever	37
Projector Parts - Remote Control for Android TV™	13	Resizing the Image with Zoom	38
 		Image Aspect Ratio	39
Setting Up the Projector	15	Changing the Image Aspect Ratio	39
<hr/>		Available Image Aspect Ratios	40
Projector Placement	16	Projected Image Appearance with Each Aspect Mode	40
Projector Setup and Installation Options	17	Adjusting Image Quality (Color Mode)	41
Projection Distance	18	Changing the Color Mode	41
Projector Connections	19	Available Color Modes	41
Connecting to a Streaming Media Player	19	Turning On Automatic Luminance Adjustment	41
Connecting to Video Sources	21	Adjusting the Sharpness	43
Connecting Headphones	22	Adjusting the Image Color	44
Connecting to Bluetooth® Audio Devices	23	Adjusting the Color Temperature	44
Bluetooth Specifications	24	Adjusting the RGB Offset and Gain	44
Installing Batteries in the Remote Control	25	Adjusting the Hue, Saturation, and Brightness	45
Remote Control Operation	25	Adjusting the Gamma	46
Pairing the Remote Control with the Streaming Media Player	26	Adjusting the Light Source Brightness	48
 		Saving Settings to Memory and Using Saved Settings	49
Using Basic Projector Features	27	Controlling the Volume with the Volume Buttons	50
<hr/>		Changing the Sound Mode	51
Turning On the Projector	28		
Turning Off the Projector	29		

Available Sound Modes 51

Adjusting Projector Features 52

HDMI Link Features 53

Operating the Connected Devices Using the HDMI Link Features 53

Shutting Off the Image and Sound Temporarily (A/V Mute)..... 55

Projector Security Features..... 56

Locking the Projector's Buttons..... 56

Unlocking the Projector's Buttons 56

Installing a Security Cable..... 57

Adjusting the Menu Settings 58

Using the Projector's Menus 59

Using the Displayed Keyboard 60

Available Text Using the Displayed Keyboard 60

Image Quality Settings - Image Menu..... 61

Projector Feature Settings - Settings Menu 62

Projector Information Display - Info Menu 65

Info Menu - Projector Info Menu 65

Projector Reset Options - Reset Menu 67

Maintaining the Projector 68

Projector Maintenance 69

Cleaning the Projection Window 70

Cleaning the Projector Case..... 71

Air Filter and Vent Maintenance 72

Cleaning the Air Filter and Vents 72

Replacing the Air Filter 72

Solving Problems 74

Projection Problems..... 75

Projector Indicator Status 76

Solving Projector Power-On or Power-Off Problems 78

Solving Projector Power Problems 78

Solving Projector Shutdown Problems..... 78

Solving Image Problems 79

Solving Missing Image Problems 79

Adjusting an Image that is not Rectangular 79

Adjusting a Fuzzy or Blurry Image..... 80

Fixing Partial Image Problems..... 80

Adjusting an Image that Contains Noise or Static..... 80

Adjusting an Image with Incorrect Brightness or Colors 81

Adjusting an Upside-down Image..... 81

Solving Missing or Low Audio Problems 82

Solving Bluetooth Problems 83

Solving Remote Control Operation Problems..... 84

Solving HDMI Link Problems 85

Solving Epson Streaming Media Player Problems..... 86

Appendix 87

Optional Accessories and Replacement Parts..... 88

Mounts..... 88

Replacement Parts 88

Screen Size and Projection Distance 89

Supported Monitor Display Resolutions..... 91



Projector Specifications.....	92
Connector Specifications.....	92
External Dimensions	93
List of Safety Symbols and Instructions	94
Laser Safety Information.....	96
Laser Warning Labels.....	96
Glossary.....	98
Notices.....	99
FCC Compliance Statement	99
Indication of the manufacturer and the importer in accordance with requirements of EU directive.....	100
Restriction of Use	100
Trademarks.....	100
Copyright Notice.....	101
Copyright Attribution.....	101

Notations Used in This Guide







Safety Symbols

The projector and its manuals use graphical symbols and labels to indicate content that tells you how to use the projector safely.

Read and carefully follow the instructions that are marked with these symbols and labels to avoid injury to persons or damage to property.

 Warning	This symbol indicates information that, if ignored, could possibly result in personal injury or even death.
 Caution	This symbol indicates information that, if ignored, could possibly result in personal injury or physical damage due to incorrect handling.

General Information Notations

Attention	This label indicates procedures that may result in damage or injury if sufficient care is not taken.
	This label indicates additional information that may be useful to know.
 button	Indicates the buttons on the remote control or the control panel. Example:  button
Menu/Setting name	Indicates projector menu and setting names. Example: Select the Image menu.  Image > Color
	This label indicates links to the related pages.
	This label indicates the projector's current menu level.

Using the Manual to Search for Information

The PDF manual allows you to search for information you are looking for by keyword, or jump directly to specific sections using the bookmarks. You can also print only the pages you need. This section explains how to use a PDF manual that has been opened in Adobe Reader X on your computer.

Searching by keyword

Click **Edit > Advanced Search**. Enter the keyword (text) for information you want to find in the search window, and then click **Search**. Hits are displayed as a list. Click one of the displayed hits to jump to that page.

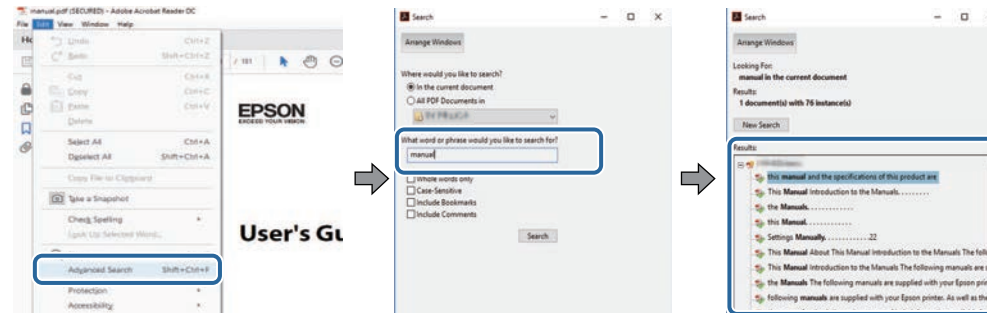

Jumping directly from bookmarks

Click a title to jump to that page. Click + or > to view the lower level titles in that section. To return to the previous page, perform the following operation on your keyboard.

- Windows: Hold down **Alt**, and then press ←.
- Mac OS: Hold down the command key, and then press ←.

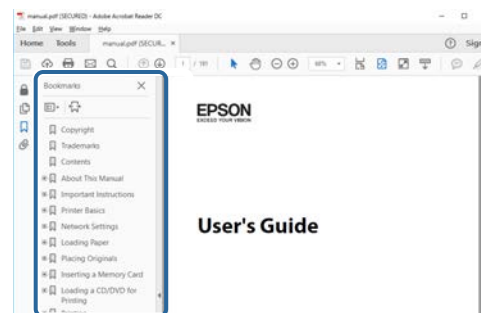

Printing only the pages you need

You can extract and print only the pages you need. Click **Print** in the **File** menu, and then specify the pages you want to print in **Pages in Pages to Print**.

- To specify a series of pages, enter a hyphen between the start page and the end page.
Example: 20-25

- To specify pages that are not in series, divide the pages with commas.
Example: 5, 10, 15

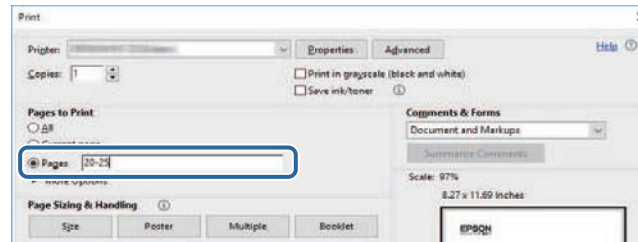

Introduction to Your Projector

See these sections to learn more about your projector.

► **Related Links**

- "Projector Parts and Functions" [p.9](#)

The following sections explain the projector parts and their functions.

► **Related Links**

- "Projector Parts - Front/Top" [p.9](#)
- "Projector Parts - Rear" [p.10](#)
- "Projector Parts - Base" [p.10](#)
- "Projector Parts - Control Panel" [p.11](#)
- "Projector Parts - Projector Remote Control" [p.11](#)
- "Projector Parts - Remote Control for Android TV™" [p.13](#)

Projector Parts - Front/Top

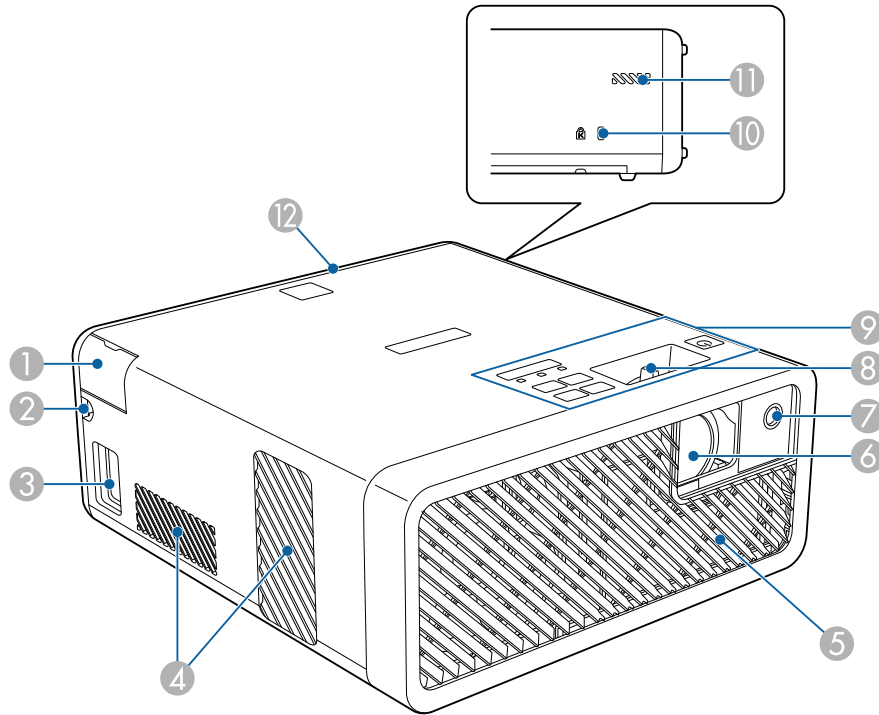

Name	Function
① Audio Out port cover	Open to connect headphones.
② Cable path	Pass an HDMI cable connecting the projector and video equipment through here.
③ Power inlet	Connects the power cord to the projector.
④ Air exhaust vents	Exhaust vents for air used to cool the projector internally. <div style="border: 1px solid black; padding: 5px; background-color: #ffffcc;"> <p>⚠ Caution</p> <p>While projecting, do not put your face or hands near the air exhaust vent, and do not place objects that may become warped or damaged by heat near the vent. Hot air from the air exhaust vent could cause burns, warping, or accidents to occur.</p> </div>
⑤ Air intake vent (air filter)	Takes in air to cool the projector internally.
⑥ Projection window	Images are projected from the lens inside the projector.
⑦ Remote receiver	Receives signals from the remote control.
⑧ Focus lever	Adjusts the image focus.
⑨ Control panel	Operates the projector.
⑩ Security slot	The security slot is compatible with the Microsaver Security System manufactured by Kensington.
⑪ Air intake vent	Takes in air to cool the projector internally.
⑫ Rear cover	Open to connect a streaming media player or other video equipment.

► **Related Links**

- "Remote Control Operation" [p.25](#)
- "Projector Parts - Control Panel" [p.11](#)
- "Focusing the Image Using the Focus Lever" [p.37](#)
- "Connecting to Video Sources" [p.21](#)
- "Connecting Headphones" [p.22](#)
- "Installing a Security Cable" [p.57](#)

Projector Parts - Rear

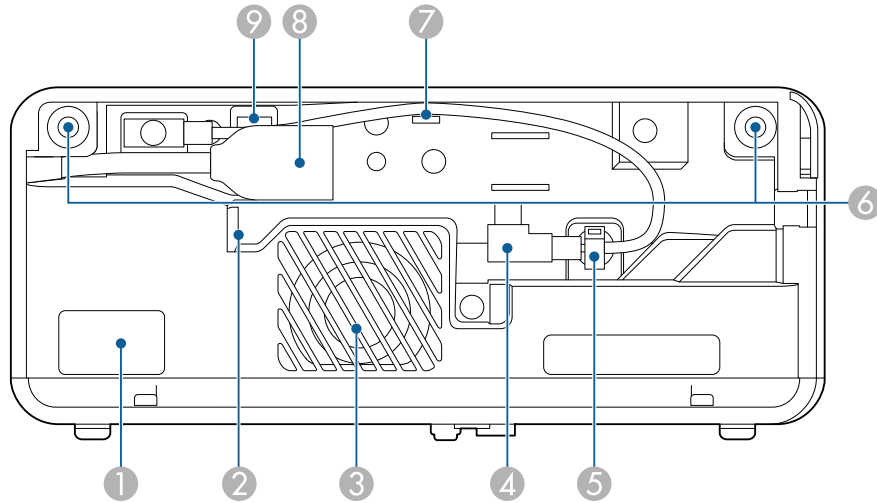

Name	Function
① Remote receiver	Receives signals from the remote control.
② Air exhaust vent	Exhaust vents for air used to cool the streaming media player.
③ Speaker	Outputs audio.
④ Power supply USB cable	Connects to a streaming media player to power it.
⑤ Cable clamp	Pass the power supply USB cable through here to secure it.
⑥ Rear cover slots	Slots to install the rear cover.
⑦ Cable hook	Pass the power supply USB cable through here.
⑧ HDMI port with an extension cable	Inputs video signals from a streaming media player or other HDMI compatible video equipment. This projector is compatible with HDCP. You cannot remove this extension cable.

Name	Function
⑨ Service port	This port is not normally used.

► Related Links

- "Remote Control Operation" [p.25](#)
- "Connecting to Video Sources" [p.21](#)
- "Connecting to a Streaming Media Player" [p.19](#)

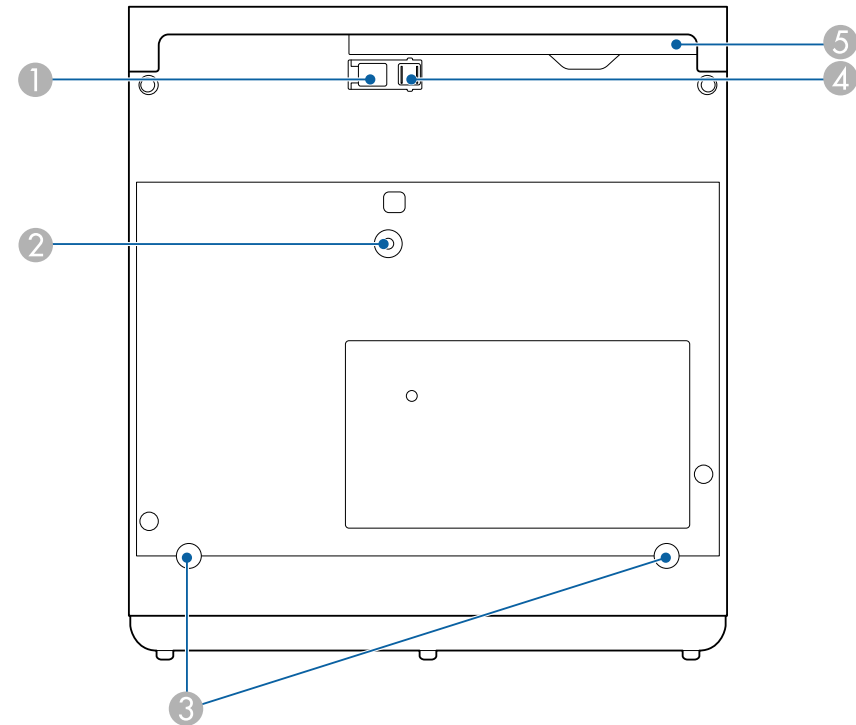

Projector Parts - Base



Name	Function
① Foot release lever	Press the foot release lever to extend and retract the front adjustable foot.
② Ceiling Mount / Floor Stand fixing point or Lighting Track Mount fixing point	Attach the optional Ceiling Mount / Floor Stand or Lighting Track Mount here.
③ Rear feet (Ceiling Mount / Floor Stand fixing points or Lighting Track Mount fixing points)	Loosen these feet by turning them counterclockwise, and then remove them to attach the optional Ceiling Mount / Floor Stand or Lighting Track Mount.
④ Front adjustable foot	When setup on a surface such as a desk, extend the foot to adjust the position of the image.
⑤ Air filter cover	Open to access the air filter.

» **Related Links**

- "Air Filter and Vent Maintenance" [p.72](#)
- "Adjusting the Image Height" [p.32](#)

Name	Function
① Power button	Turns the projector on or off.
② Focus lever	Adjusts the image focus.
③ Indicators	Indicates the projector's status.
④ Volume up/down buttons 	Adjusts the volume for the speaker and headphones. You can also control the volume for Bluetooth audio devices connected to the projector.
⑤ Horizontal keystone buttons 	Displays the Keystone screen allowing you to correct horizontal keystone distortion.

» **Related Links**

- "Projector Indicator Status" [p.76](#)
- "Correcting the Image Shape Horizontally with the Horizontal Keystone Buttons" [p.33](#)
- "Turning On the Projector" [p.28](#)
- "Focusing the Image Using the Focus Lever" [p.37](#)
- "Controlling the Volume with the Volume Buttons" [p.50](#)

Projector Parts - Control Panel

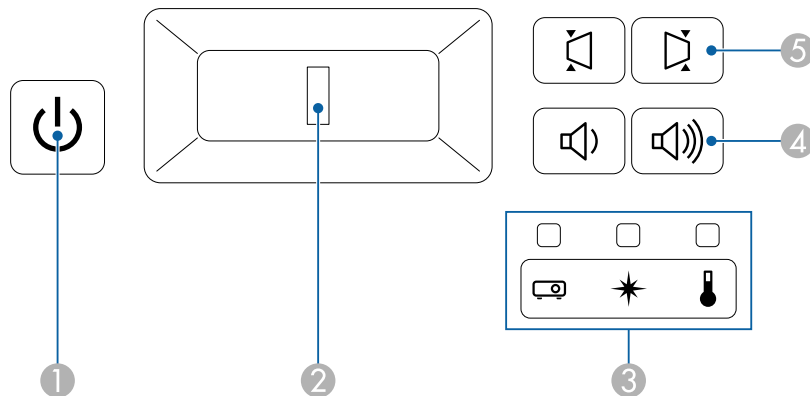







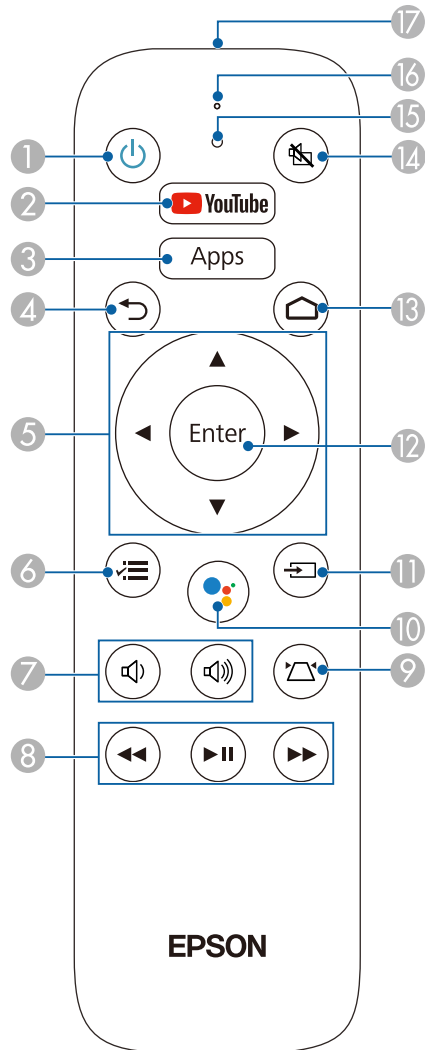





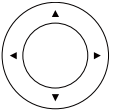

Projector Parts - Projector Remote Control

You can operate your projector and Epson streaming media player (ELPAP12) using this remote control.

Unless otherwise stated, all of the operations using a remote control in this guide are explained using this remote control.



Name		Function
1	Power button 	Turns the projector on or off.
2	YouTube button 	Starts the YouTube application.
3	Apps button 	Displays a list of the applications available on the Android TV™.
4	Esc button 	Stops the current function. Moves back to the previous menu level while displaying the projector's menu.
5	Arrow buttons 	Selects menu items while displaying the projector's menu.
6	Menu button 	Displays and closes the projector's menu. You can use the projector's menus to adjust the settings that control how your projector works. Hold down this button to display the Bluetooth menu.
7	Volume up/down buttons 	Adjusts the volume for the speaker and headphones. You can also control the volume for Bluetooth audio devices connected to the projector.
8	Playback control buttons 	Controls playback of the connected streaming media player or video equipment that supports the HDMI CEC standard.
9	Keystone button 	Displays the Keystone adjustment screen or the Quick Corner screen.

Name	Function
10 Mic button 	Allows you to operate your Android TV™ using voice commands. When you press this button, the remote control's microphone starts listening for voice commands.
11 Source Search button 	This is not used for this model.
12 Enter button 	Enters the current selection and moves to the next level while displaying the projector's menu.
13 Home button 	Displays the Android TV™ home screen.
14 A/V Mute button 	Turns the video and audio on or off temporarily.
15 Indicator	Turns on when outputting signals from the remote control.
16 Microphone	Detects audio when you press the Mic button.
17 Remote control light emitting area	Outputs remote control signals.







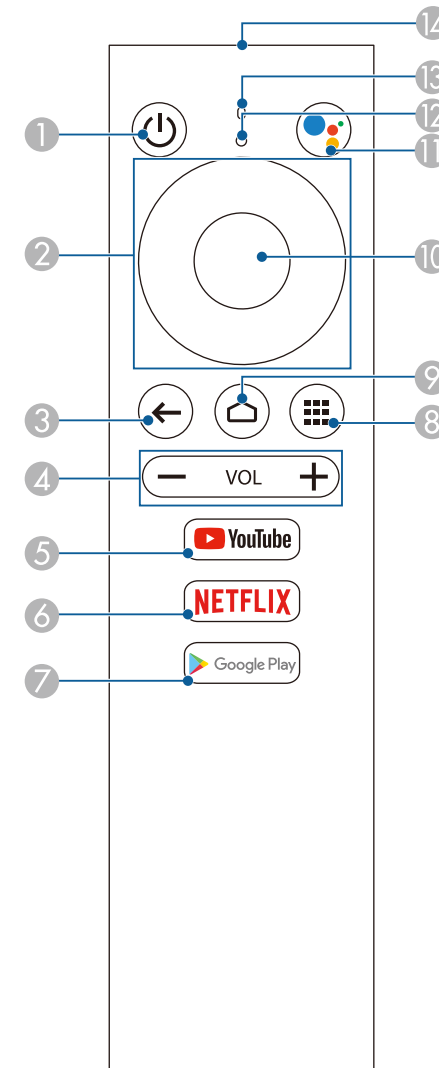

» Related Links

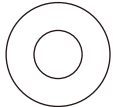
- "Adjusting Image Quality (Color Mode)" [p.41](#)
- "Correcting the Image Shape with the Keystone Button" [p.34](#)
- "Correcting the Image Shape with Quick Corner" [p.35](#)
- "Turning On the Projector" [p.28](#)
- "Controlling the Volume with the Volume Buttons" [p.50](#)
- "Shutting Off the Image and Sound Temporarily (A/V Mute)" [p.55](#)
- "Using the Projector's Menus" [p.59](#)

Projector Parts - Remote Control for Android TV™

You can operate the Epson streaming media player (ELPAP12) using this remote control.



Name	Function
① Power button 	Turns the Epson streaming media player on or off.
② Directional pad 	Selects menu items on the Android TV™.
③ Esc button 	Moves back to the previous menu level on the Android TV™.
④ Volume up/down buttons 	Adjusts the volume for the Epson streaming media player.
⑤ YouTube button 	Starts the YouTube application.
⑥ Netflix button 	Starts the Netflix application.
⑦ Google Play button 	Connects to Google Play.
⑧ Applications button 	Displays a list of the applications available on the Android TV™.
⑨ Home button 	Displays the Android TV™ home screen.
⑩ Enter button 	Enters the current selection and moves to the next level on the Android TV™.

Name	Function
⑪ Mic button 	Allows you to operate your Android TV™ using voice commands. When you press this button, the remote control's microphone starts listening for voice commands.
⑫ Indicator 	Turns on when outputting signals from the remote control.
⑬ Microphone 	Detects audio when you press the Mic button.
⑭ Remote control light emitting area 	Outputs remote control signals.

Setting Up the Projector

Follow the instructions in these sections to set up your projector.

► **Related Links**

- "Projector Placement" [p.16](#)
- "Projector Connections" [p.19](#)
- "Installing Batteries in the Remote Control" [p.25](#)

You can place the projector on almost any flat surface to project an image.

You can also install the projector in a mount if you want to use it in a fixed location. An optional Ceiling Mount / Floor Stand is required when installing the projector on a ceiling, a wall, or a floor.

The projector can be installed at various angles. There is no vertical or horizontal limit to how the projector can be installed.

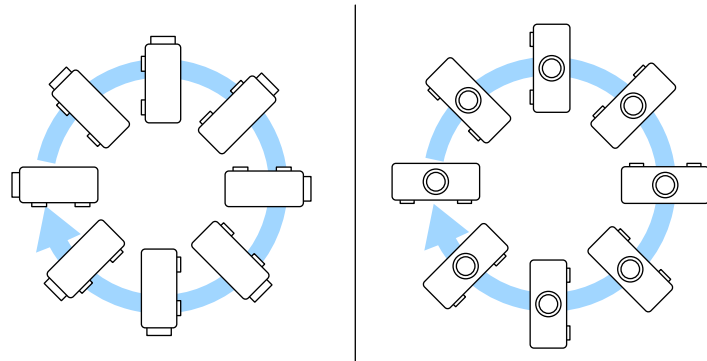

- Place the projector so it squarely faces the screen, not at an angle.

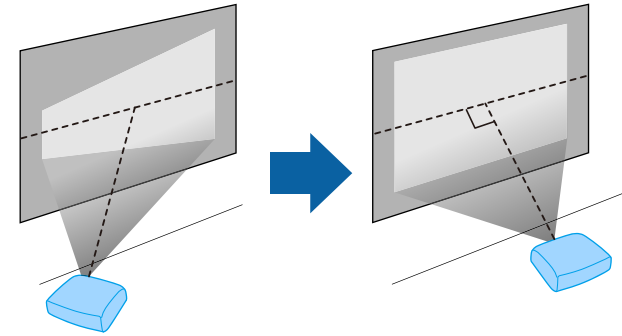

 If you cannot install the projector squarely facing the screen, correct any resulting keystone distortion using the projector controls. For the best quality images, we recommend adjusting the installation position of the projector to achieve the correct image size and shape.

Note the following points when selecting a projector location:

- Place the projector on a sturdy, level surface or install it using a compatible mount.

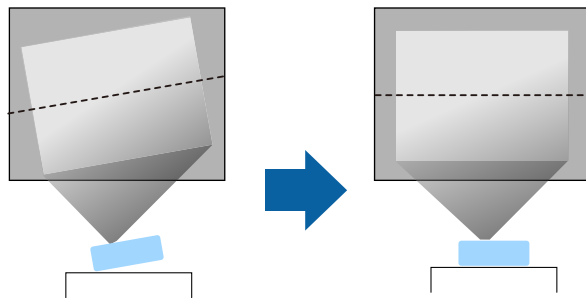

- Leave plenty of space around and under the projector for ventilation, and do not place it on top of or next to anything that could block the vents.

Warning

- You must install a ceiling mount when suspending the projector from a ceiling. If you do not install the projector correctly, it could fall and cause damage or injury.
- Do not use adhesives on the ceiling mount fixing points to prevent the screws from loosening, or use lubricants, oils, or similar substances on the projector; the projector case may crack causing it to fall from its ceiling mount. This could cause serious injury to anyone under the ceiling mount and could damage the projector.
- Do not cover the projector's air intake or air exhaust vents. If the vents are covered, the internal temperature could rise and cause a fire.
- Do not install the projector on an unstable surface or in a location beyond the weight specifications of the projector. Otherwise, it could fall or topple causing an accident and injury.
- When installing the projector in a high position, take measures to prevent falling by using belts to ensure safety in an emergency, such as an earthquake, and to prevent accidents. If it is not installed correctly, it could fall causing an accident and injury.
- Do not install the projector in locations exposed to high humidity and dust, such as on a kitchen counter, in the kitchen, or near a humidifier, or in locations exposed to oil smoke or steam. Doing so could cause fire or electric shock. In addition, the oil content could cause the projector's outer case to deteriorate and could cause the projector to fall off from the ceiling where it is suspended.

Attention

- If you are using the projector at altitudes above 1500 m, set the **High Altitude Mode** setting to **On** in the projector's menu to ensure the projector's internal temperature is regulated properly.
 - ☛ **Settings > Installation > High Altitude Mode**
- Try not to setup the projector in locations subject to high humidity and dust, or in locations subject to smoke from fires or tobacco smoke.
- If the internal temperature of the projector gets too high due to the installation environment, select the **Rear Bay Cooling** setting in the projector menu to cool the streaming media player connected to the projector.
 - ☛ **Settings > Operation > Rear Bay Cooling**

- "Projection Distance" [p.18](#)
- "Image Shape" [p.33](#)
- "Projector Feature Settings - Settings Menu" [p.62](#)
- "Adjusting the Image Height" [p.32](#)
- "Resizing the Image with Zoom" [p.38](#)
- "Focusing the Image Using the Focus Lever" [p.37](#)

Projector Setup and Installation Options

You can set up or install your projector in the following ways:

Front/Rear

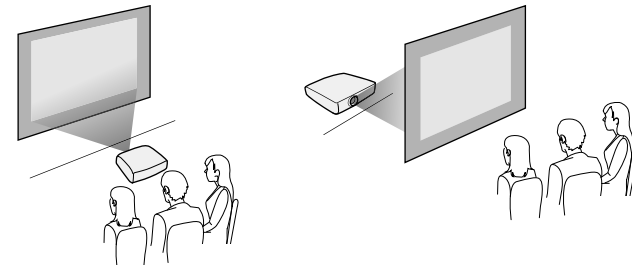

Front Ceiling/Rear Ceiling

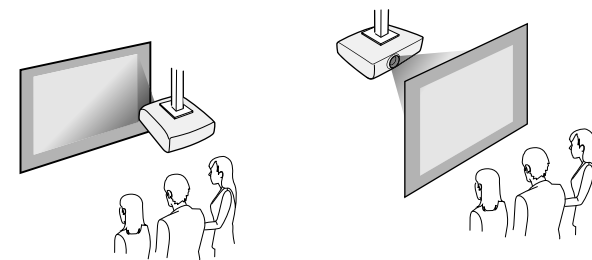

» Related Links

- "Projector Setup and Installation Options" [p.17](#)



If you project from the ceiling or from the rear, select the correct **Projection** setting and, if necessary, adjust the **OSD Rotation** setting.
☛ **Settings > Installation > OSD Rotation**

Projecting Images onto a Ceiling

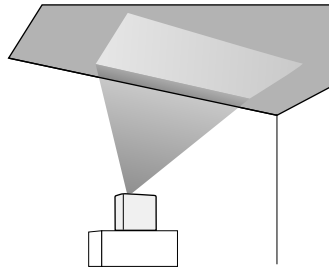

Warning

Do not cover the projection window. If the window is covered, the internal temperature could rise and cause a fire.

Attention

When projecting images onto a ceiling, make sure that the rear cover is replaced correctly.

▶▶ **Related Links**

- "Projection Modes" [p.31](#)

Projection Distance

The distance at which you place the projector from the screen determines the approximate size of the image. The image size increases the farther the projector is from the screen, but can vary depending on the zoom factor, aspect ratio, and other settings.

See the Appendix for details about how far to place the projector from the screen based on the size of the projected image.



When correcting keystone distortion, your image is slightly smaller.

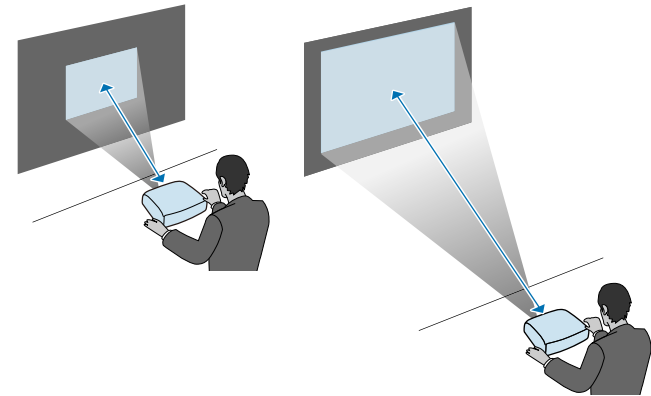

▶▶ **Related Links**

- "Screen Size and Projection Distance" [p.89](#)

See these sections to connect the projector to a variety of projection sources.

Attention

Check the shape and orientation of the connectors on any cable you plan to connect. Do not force a connector into a port if it does not fit. The device or your projector could be damaged or could malfunction.



See the *Quick Start Guide* for a list of cables supplied with your projector. Purchase optional or commercially available cables when necessary.

» Related Links

- "Connecting to a Streaming Media Player" [p.19](#)
- "Connecting to Video Sources" [p.21](#)
- "Connecting Headphones" [p.22](#)
- "Connecting to Bluetooth® Audio Devices" [p.23](#)

Connecting to a Streaming Media Player

You can connect your streaming media player to the projector's HDMI port.

By connecting the power supply USB cable, you can power the streaming media player from the projector.

- 1** Remove the rear cover from the projector.

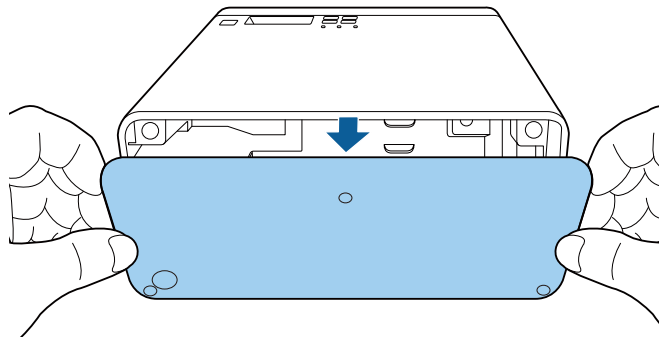

- 2** Release the power supply USB cable from the cable hook and cable clamp.

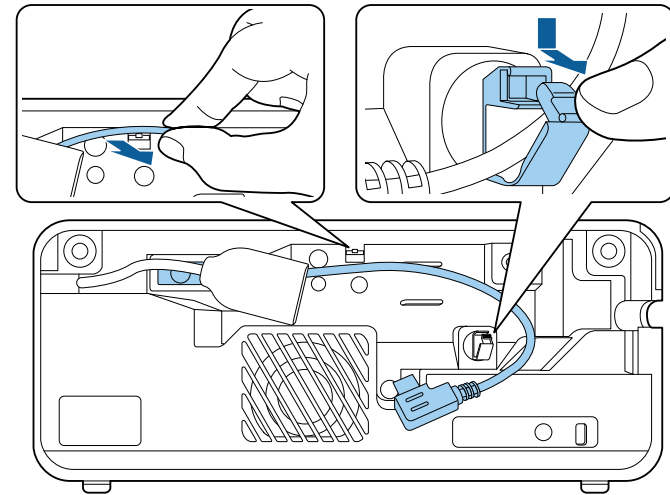

- 3** Connect your streaming media player to the projector's HDMI port.

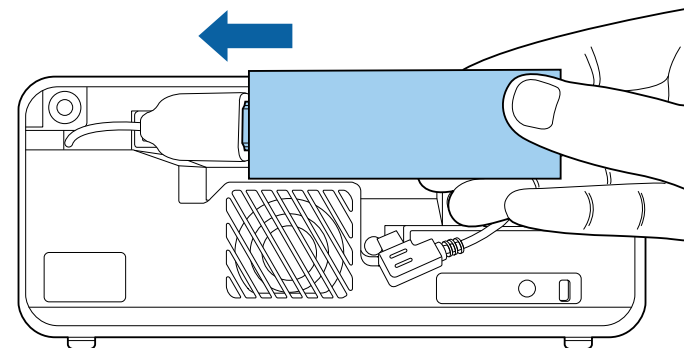

4 Connect the power supply USB cable to the streaming media player's USB port (Type-B).

- USB port on the side

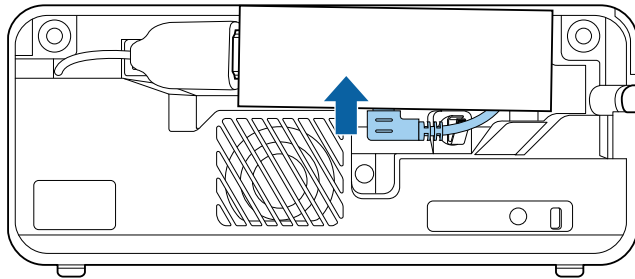

- USB port at the bottom

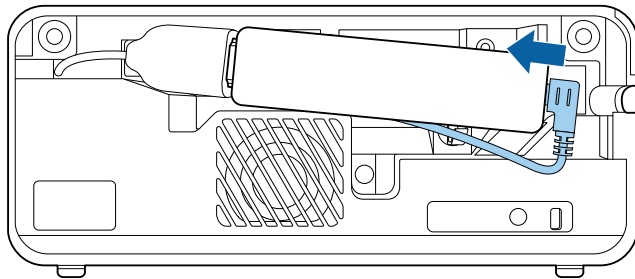

5 Pass the power supply USB cable through the cable hook and cable clamp, and then close the cable clamp to secure the cable.

- USB port on the side

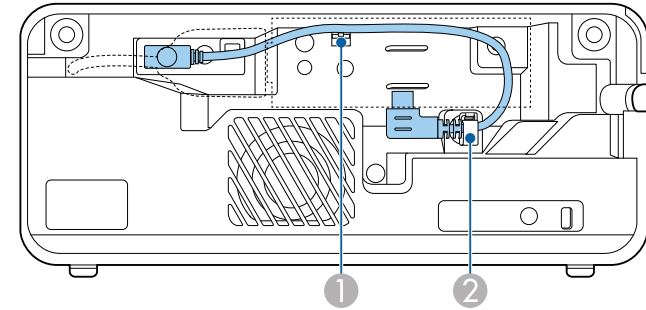

- USB port at the bottom

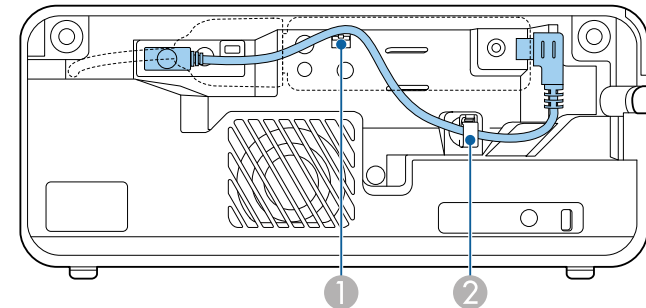

6 Place the streaming media player as shown.

- USB port on the side

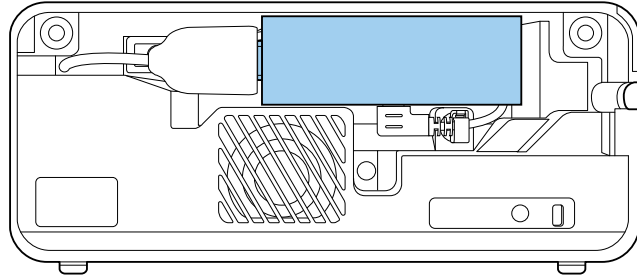

- USB port at the bottom

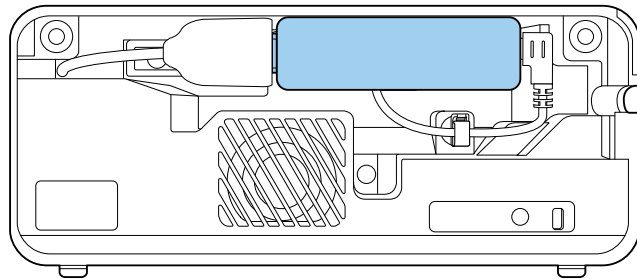

7 Replace the rear cover.



After connecting the streaming media player to your projector, you need to pair the remote control with the streaming media player so that you can operate the device with the remote control.

► Related Links

- "Pairing the Remote Control with the Streaming Media Player" [p.26](#)

Connecting to Video Sources

If your video source has an HDMI port, you can connect it to the projector using an HDMI cable and send the image source's audio with the projected image.

Attention

Do not turn on the video source before connecting it to the projector. Doing so could damage the projector.



- If the port on the device you connect has an unusual shape, use the cable supplied with the device or an optional cable to connect to the projector.
- Some video equipment is capable of outputting different types of signals. See your video equipment manual to confirm what type of signals can be output.

1 Remove the rear cover from the projector.

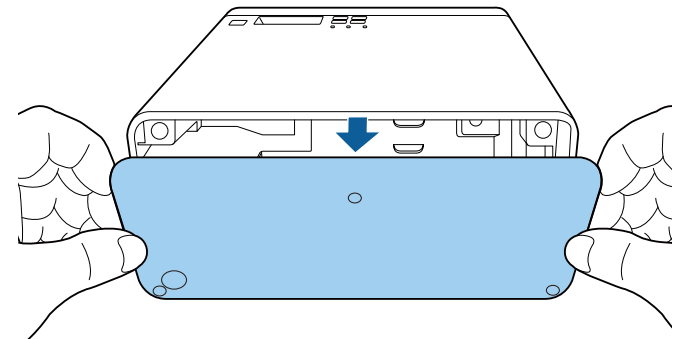

2 Connect the HDMI cable to your video source's HDMI output port.

- 3** Connect the other end to the projector's HDMI port.

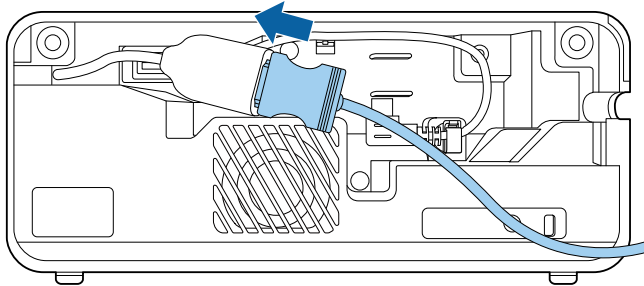

- 4** Pass the HDMI cable through the cable path as shown.

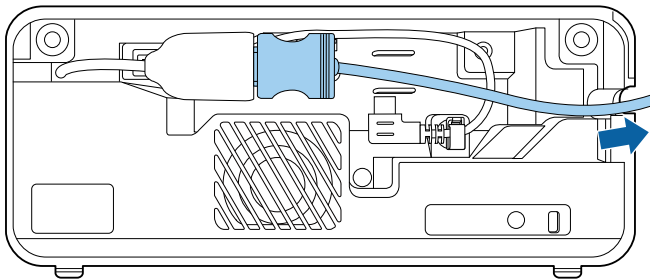

- 5** Replace the rear cover.

Connecting Headphones

You can connect headphones to the projector's Audio Out port. You can control the volume using the projector's remote control.

Attention

The projector's Audio Out port only supports 3-pin headphones. If you use any other headphones, audio may not be output normally.

- 1** Open the Audio Out port cover.

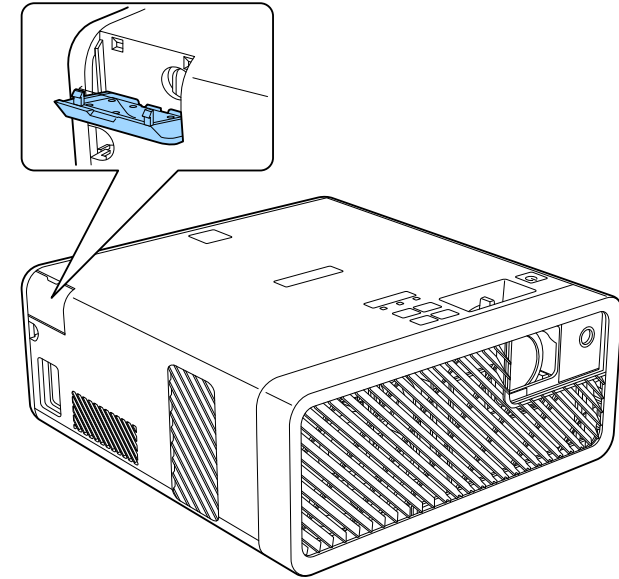

- 2** Connect the stereo headphone's mini-jack cable to the projector's Audio Out port.

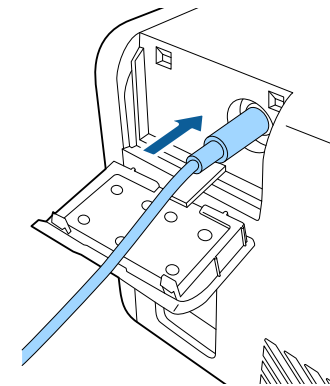

Caution

Do not start a playback at a high volume setting. Sudden loud noises may cause hearing loss.

Always lower the volume before powering off, so that you can power on and then gradually increase the volume.

Connecting to Bluetooth® Audio Devices

You can connect your projector to Bluetooth audio devices (A2DP compliant) such as speakers or headphones to output audio from streaming media player or other video equipment connected to the projector.



- There is a delay in the audio output from any Bluetooth audio devices.
- Bluetooth audio devices are not supported in some countries and regions.

1 Turn on the projector and display an image.

2 Hold down the  button on the remote control for about two seconds.

The **Bluetooth** screen is displayed.



You can also select Bluetooth settings in the projector's **Settings** menu.

 **Settings > Sound > Bluetooth**

3 Select **On** as the **Bluetooth Audio** setting.

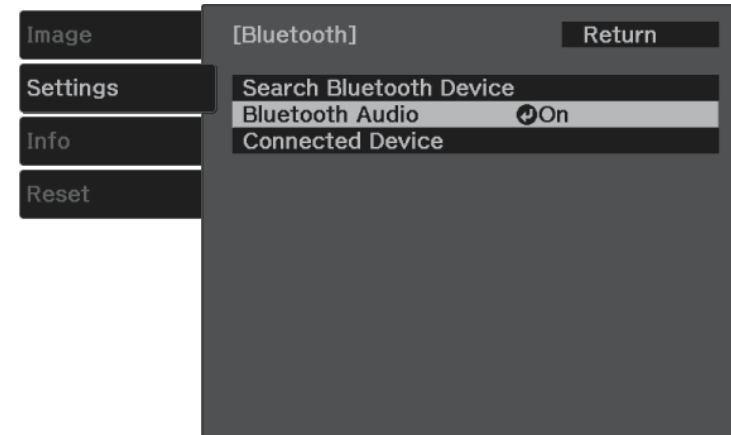

4 Turn on "pairing mode" on the Bluetooth audio device you want to connect to. See your Bluetooth audio device manual for details.

5 Select **Search Bluetooth Device** and press .
A list of available devices is displayed.

6 Select the Bluetooth audio device you want to connect to and press .

7 Press  or  to exit the menus.

The next time you turn on the projector, the last connected device is automatically connected to the projector. To change the connected device, repeat from steps 4.

» Related Links

- "Bluetooth Specifications" [p.24](#)

Bluetooth Specifications

Version	Bluetooth Ver. 3.0
Output	Class 2
Communication distance	Approx. 10 m
Supported profiles	A2DP
Content protection	SCMS-T
Frequency used	2.4 GHz band (2.402 to 2.480 GHz)
Supported codecs	SBC, Qualcomm [®] aptX [™] audio

Warning

Do not use the device near any medical equipment or equipment that is automatically controlled, such as automatic doors or fire alarms. Electromagnetic interference from the device may cause such equipment to malfunction and cause an accident.



- Connect a Bluetooth device that supports copyright protection (SCMS-T).
- You may not be able to connect depending on the standard and type of device.
- Even when connecting within the specified communication distance, connections can be lost due to the status of the signal.
- The communication method for Bluetooth uses the same frequency (2.4 GHz) as wireless LAN (IEEE802.11b/g) or microwave ovens. Therefore, if these devices are used at the same time, radio wave interference may occur, the audio may be interrupted, or communication may not be possible. If you do need to use these devices at the same time, make sure there is enough distance between them and the Bluetooth device.
- You cannot connect multiple Bluetooth devices to the projector at the same time.

The remote control uses the two AAA batteries that came with the projector.

Attention

Make sure you read the *Safety Instructions* before handling the batteries.

- 1 Remove the battery cover as shown.

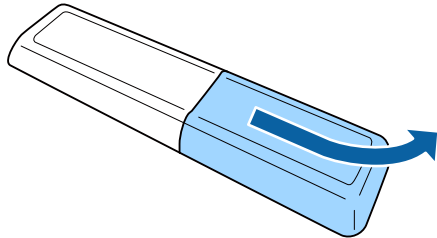

- 2 Remove the old batteries, if necessary.



Dispose of used batteries according to local regulations.

- 3 Insert the batteries with the + and - ends facing as shown.

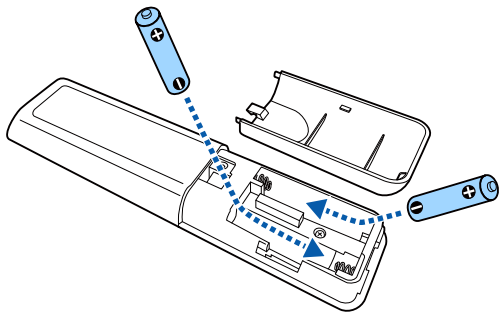

Warning

Check the positions of the (+) and (-) marks inside the battery holder to ensure the batteries are inserted the correct way. If the batteries are not used correctly, they could explode or leak causing a fire, injury, or damage to the product.

- 4 Replace the battery cover and press it down until it clicks into place.

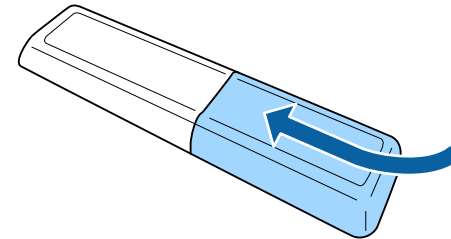

► Related Links

- "Remote Control Operation" [p.25](#)

Remote Control Operation

The remote control lets you control the projector from almost anywhere in the room.

Make sure that you aim the remote control at the projector's receivers within the distance and angles listed here.

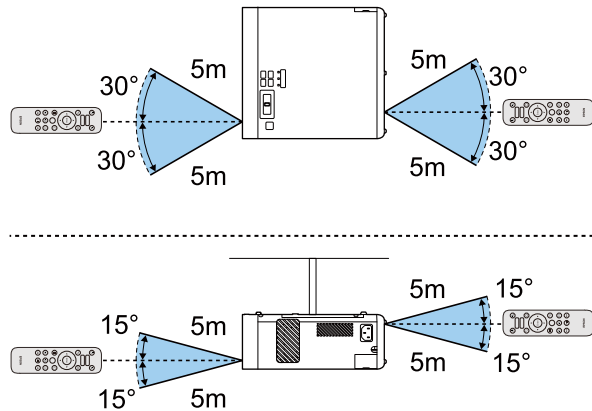

Avoid using the remote control in conditions with bright fluorescent lights or in direct sunlight, or the projector may not respond to commands. If you are not going to use the remote control for a long time, remove the batteries.

» Related Links

- "Pairing the Remote Control with the Streaming Media Player" [p.26](#)

Pairing the Remote Control with the Streaming Media Player

After connecting the streaming media player to your projector, you need to pair the remote control with the streaming media player so that you can operate the device with the remote control.

Follow the on-screen instructions to perform pairing.

» Related Links

- "Connecting to a Streaming Media Player" [p.19](#)

Using Basic Projector Features

Follow the instructions in these sections to use your projector's basic features.

► Related Links

- "Turning On the Projector" [p.28](#)
- "Turning Off the Projector" [p.29](#)
- "Selecting the Language for the Projector Menus" [p.30](#)
- "Projection Modes" [p.31](#)
- "Adjusting the Image Height" [p.32](#)
- "Image Shape" [p.33](#)
- "Focusing the Image Using the Focus Lever" [p.37](#)
- "Resizing the Image with Zoom" [p.38](#)
- "Image Aspect Ratio" [p.39](#)
- "Adjusting Image Quality (Color Mode)" [p.41](#)
- "Adjusting the Sharpness" [p.43](#)
- "Adjusting the Image Color" [p.44](#)
- "Adjusting the Light Source Brightness" [p.48](#)
- "Saving Settings to Memory and Using Saved Settings" [p.49](#)
- "Controlling the Volume with the Volume Buttons" [p.50](#)
- "Changing the Sound Mode" [p.51](#)

Turn on the streaming media player or video equipment you want to use after you turn on the projector.

- 1** Connect the power cord to the projector's power inlet and plug it into an electrical outlet.

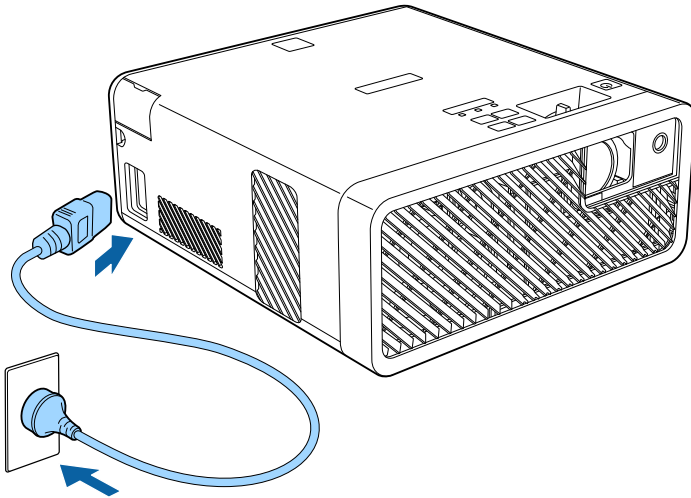

The projector enters standby mode. This indicates that the projector is receiving power, but is not yet turned on.

- 2** Press the power button on the control panel or remote control to turn on the projector.

The status indicator flashes blue as the projector warms up. Once the projector is warmed up, the status indicator stops flashing and turns blue.

The first time you turn on the projector, the **Welcome Guide** screen is displayed. The **Welcome Guide** shows product features and tips on how to use the projector.



If you want to display the **Welcome Guide** screen again, select **Welcome Guide** in the projector's **Settings** menu.

☛ **Settings > Display > Welcome Guide**

Warning

- Never look into the projector lens when the light source is on. This can damage your eyes and is especially dangerous for children.
- When turning on the projector at a distance using the remote control, make sure there is no one looking into the lens.
- During projection, do not block the light from the projector with a book or other objects. If the light from the projector is blocked, the area on which the light shines becomes hot which could cause it to melt, burn, or start a fire. Also, the lens may get hot due to the reflected light which could cause the projector to malfunction. To stop projection, use the A/V Mute function, or turn off the projector.



- When the **Direct Power On** setting is set to **On** in the projector's **Settings** menu, the projector turns on as soon as you plug it in. Note that the projector also turns on automatically in cases such as recovering from a power outage.

☛ **Settings > Operation > Direct Power On**

- This projector provides a Child Lock function to prevent children from accidentally turning the power on and a Control Panel Lock function to prevent accidental operations and so on.

☛ **Settings > Operation > Child Lock**

☛ **Settings > Operation > Control Panel Lock**

- When using at an altitude of 1500 m or more, set **High Altitude Mode** to **On**.

☛ **Settings > Installation > High Altitude Mode**

» **Related Links**

- "Projector Feature Settings - Settings Menu" [p.62](#)

Turn off the projector after use.



- Turn off this product when it is not in use to prolong the life of the projector. Light source life varies depending on the environmental conditions and usage. Brightness decreases over time.

- 1** Press the power button on the control panel or remote control.
The projector displays a shutdown confirmation screen.

Power Off?

Yes : Press  button

No : Press any other button

- 2** Press the power button again. (To leave it on, press any other button.)
The light source turns off, and the status indicator turns off.
- 3** To transport or store the projector, make sure all of the indicators on the projector are off, and then unplug the power cord.





You can keep supplying power to the streaming media player even if the projector is in standby mode by selecting **On** as the **USB Power in Standby** setting. This lets the device start earlier, or perform updates automatically over a network if necessary.

 **Settings > Operation > USB Power in Standby**





» Related Links

- "Projector Feature Settings - Settings Menu" [p.62](#)

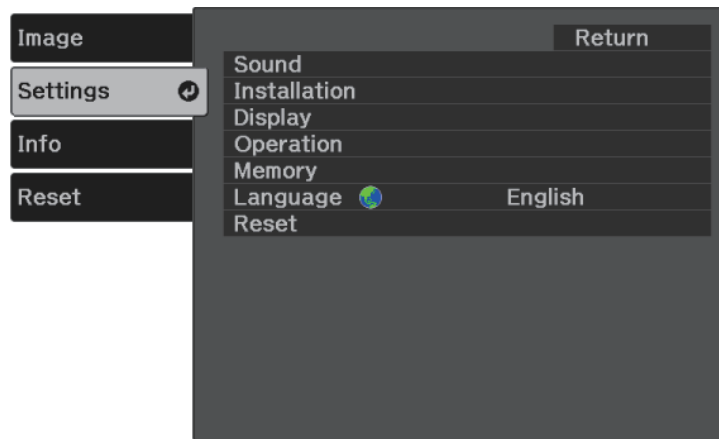
If you want to view the projector's menus and messages in another language, you can change the **Language** setting.

- 1** Turn on the projector.
- 2** Press the  button on the remote control.
- 3** Select the **Settings** menu and press .



- 4** Select the **Language** setting and press .
- 5** Select the language you want to use and press .
- 6** Press  or  to exit the menus.

Depending on how you positioned the projector, you may need to change the projection mode so your images project correctly.

- **Front** lets you project from a table in front of the screen.
- **Front/Upside Down** flips the image over top-to-bottom to project upside-down from a ceiling or wall mount.
- **Rear** flips the image horizontally to project from behind a translucent screen.
- **Rear/Upside Down** flips the image over top-to-bottom and horizontally to project from a ceiling or wall mount and behind a translucent screen.

» **Related Links**

- "Changing the Projection Mode Using the Menus" [p.31](#)
- "Projector Setup and Installation Options" [p.17](#)

Changing the Projection Mode Using the Menus

You can change the projection mode to flip the image over top-to-bottom and/or left-to-right using the projector menus.

- 1** Turn on the projector and display an image.
- 2** Press the  button on the remote control.

- 3** Select the **Settings** menu and press .

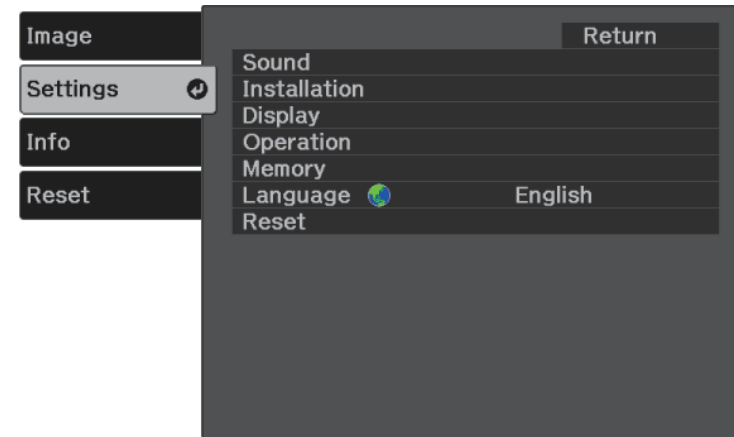

- 4** Select **Installation > Projection** and press .

- 5** Select a projection mode and press .

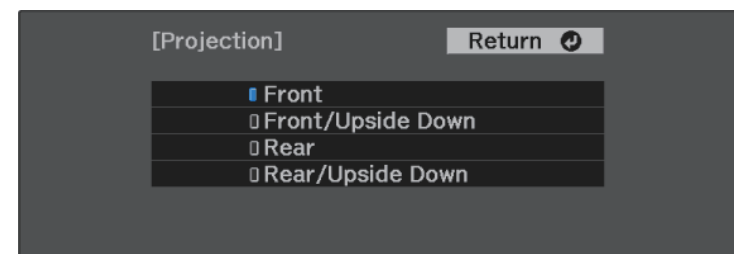

- 6** Press  or  to exit the menus.

If you are projecting from a table or other flat surface and the image is too high or low, you can adjust the image height using the projector's adjustable foot.

The larger the angle of tilt, the harder it becomes to focus. Locate the projector so that it only needs to be tilted at a small angle.

- 1** Turn on the projector and display an image.
- 2** Press the foot release lever to extend and retract the front adjustable foot.

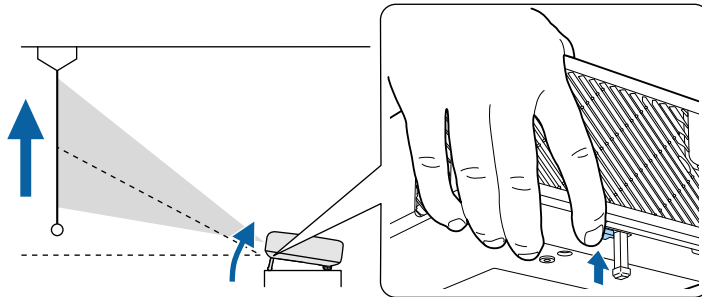

The foot extends from the projector.

You can adjust the position up to 11 degrees.

- 3** Release the lever to lock the foot.

If the projected image is unevenly rectangular, you need to adjust the image shape.

► Related Links

- ["Image Shape" p.33](#)

You can project an even, rectangular image by placing the projector directly in front of the center of the screen and keeping it level. If you place the projector at an angle to the screen, or tilt it up or down, or off to the side, you may need to correct the image shape.

After correction, your image is slightly smaller.

For the best quality images, we recommend adjusting the installation position of the projector to achieve the correct image size and shape.

► **Related Links**

- "Auto V-Keystone" [p.33](#)
- "Correcting the Image Shape Horizontally with the Horizontal Keystone Buttons" [p.33](#)
- "Correcting the Image Shape with the Keystone Button" [p.34](#)
- "Correcting the Image Shape with Quick Corner" [p.35](#)

Auto V-Keystone

When the projector is moved or tilted, **Auto V-Keystone** automatically corrects any vertical keystone distortion.

Auto V-Keystone can correct the projected image distortion in these conditions:

- The **OSD Rotation** setting is set to **Off** in the projector's **Settings** menu
 ⌨ **Settings > Installation > OSD Rotation**



- **Auto V-Keystone** can correct the shape of an image vertically in a projection angle of 360 degrees. If you want to correct the shape of the image finely, use the  button on the remote control to correct images manually.
- If you do not want to use the **Auto V-Keystone** function, set **Auto V-Keystone** to **Off** in the projector's menu.
 ⌨ **Settings > Installation > Keystone > H/V-Keystone > Auto V-Keystone**

► **Related Links**

- "Projector Feature Settings - Settings Menu" [p.62](#)

- "Correcting the Image Shape with the Keystone Button" [p.34](#)

Correcting the Image Shape Horizontally with the Horizontal Keystone Buttons

You can use the projector's horizontal keystone buttons to correct the shape of an image horizontally when it is projected as an uneven rectangle.

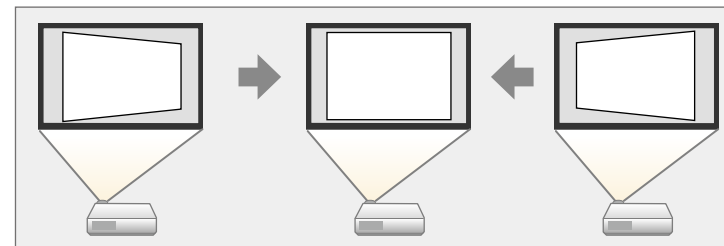

You can use horizontal keystone buttons to correct images up to 40° right or left.



- 1 Turn on the projector and display an image.
- 2 Press one of the horizontal keystone buttons on the control panel. You see the **Keystone** adjustment screen:

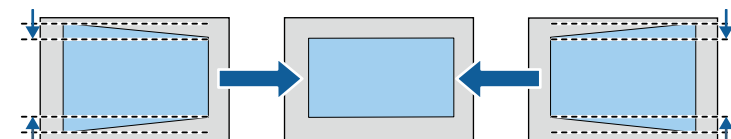

- 3 Press a keystone button to adjust the image shape.





After correction, your image is slightly smaller.

 If the projector is installed out of your reach, you can also correct the shape of the image using the  button on the remote control.

Correcting the Image Shape with the Keystone Button

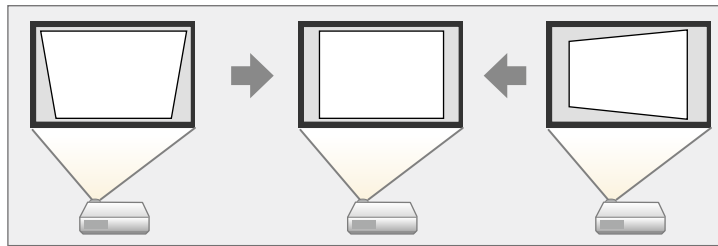
You can use the  button on the remote control to correct the shape of an image that is unevenly rectangular.



-  You cannot combine H/V-Keystone correction with other image shape correction methods.
- You can correct horizontal keystone distortion up to 40° right or left.

1 Turn on the projector and display an image.

2 Press the  button on the remote control.

You see the **Keystone** adjustment screen:



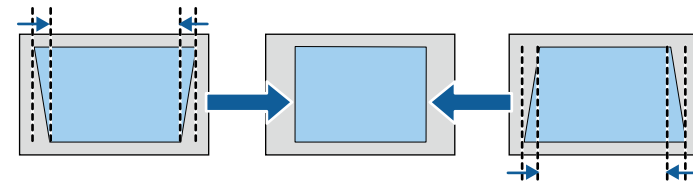

3 Use the arrow buttons on the remote control to select between vertical and horizontal keystone correction and to adjust the image shape as necessary.

• **V-Keystone**

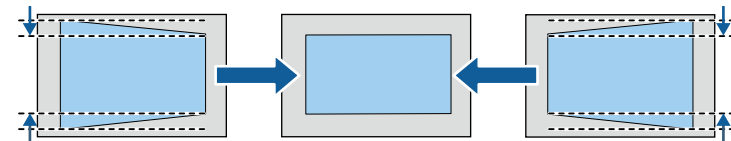

• **H-Keystone**





4 When you are finished, press .

After correction, your image is slightly smaller.

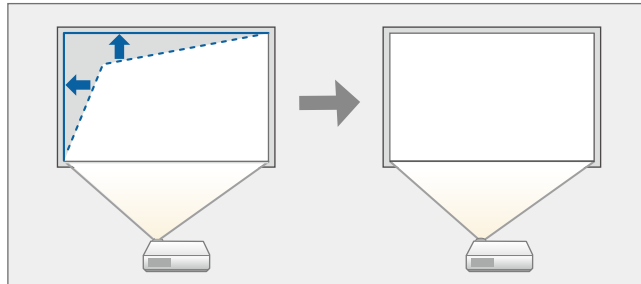

Correcting the Image Shape with Quick Corner

You can use the projector's **Quick Corner** setting to correct the shape and size of an image that is unevenly rectangular.

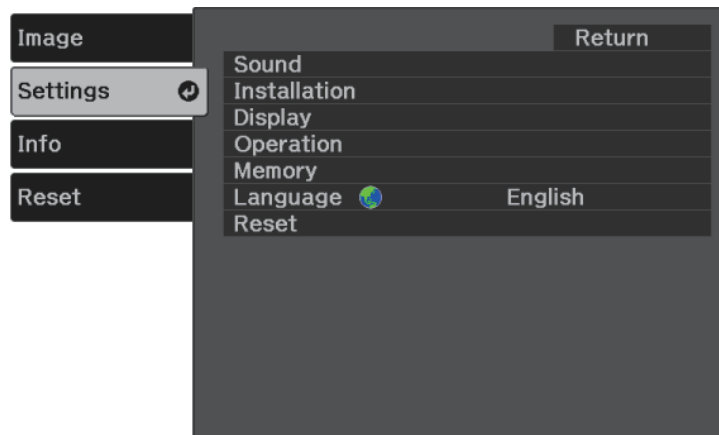

- 1** Turn on the projector and display an image.
- 2** Press the  button on the remote control.
- 3** Select the **Settings** menu and press .



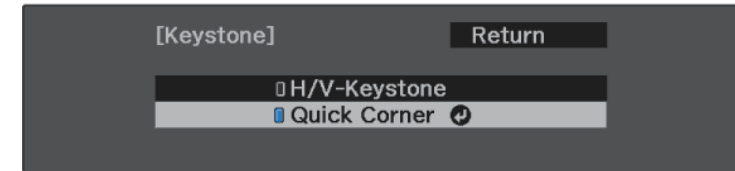

- 4** Select **Installation** > **Keystone** and press .
- 5** Select **Quick Corner** and press . Then press  again if necessary.

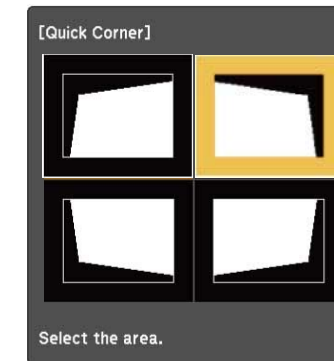

You see the area selection screen.

- 6** Use the arrow buttons to select the corner of the image you want to adjust. Then press .



To reset the Quick Corner corrections, hold down  for about two seconds while the area selection screen is displayed, and then select **Yes**.

- 7** Press the arrow buttons to adjust the image shape as necessary.

To return to the area selection screen, press .

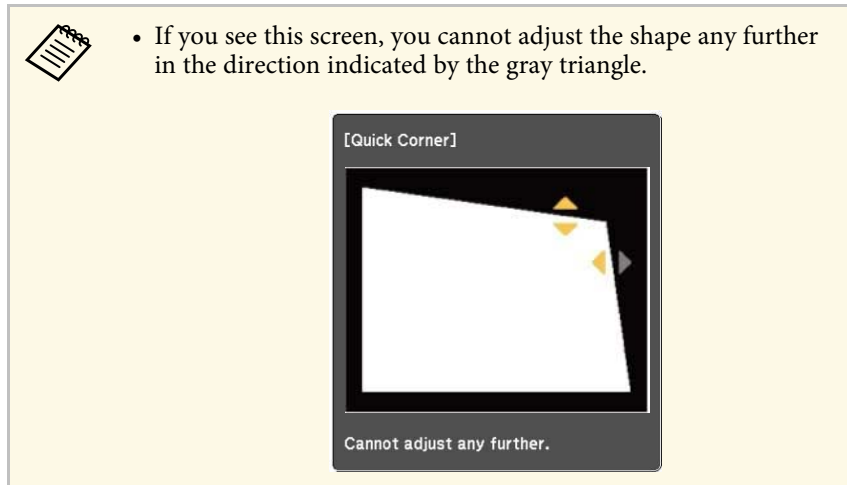

8 Repeat steps 6 and 7 as needed to adjust any remaining corners.

9 When you are finished, press .

» Related Links

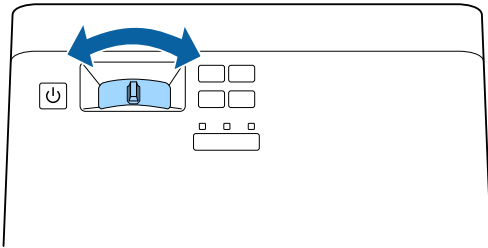
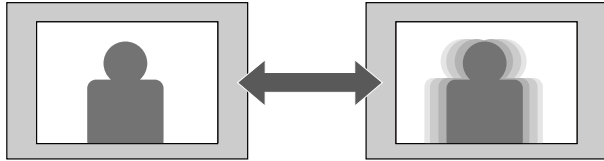

- "Projector Feature Settings - Settings Menu" [p.62](#)

You can correct the focus using the focus lever.

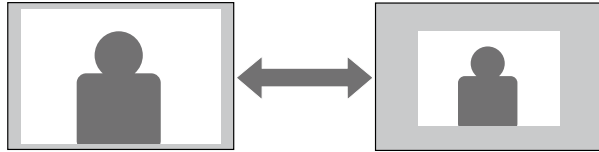

You can resize the image using the projector's menu.



- 1 Turn on the projector and display an image.
- 2 Press the  button on the remote control.
- 3 Select the **Settings** menu and press .

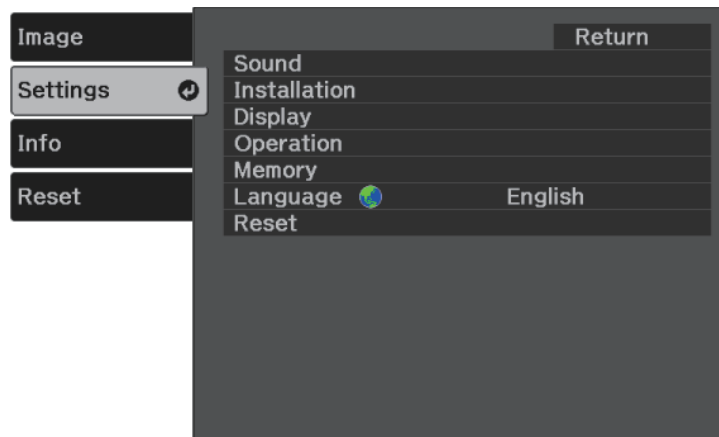

- 4 Select **Installation** > **Zoom** and press .

- 5 Press the left or right arrow button to adjust the zoom setting and press .

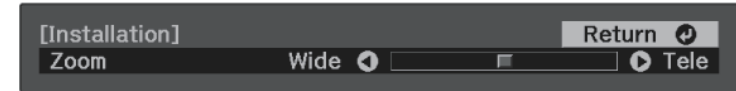

- 6 Press  or  to exit the menus.

The projector can display images in different width-to-height ratios called aspect ratios. Normally, the input signal from your video source determines the image's aspect ratio. However, you can change the aspect ratio for certain images to fit your screen.

If you always want to use a particular aspect ratio for a certain video input source, you can select it using the projector's **Image** menu.

» Related Links

- "Changing the Image Aspect Ratio" [p.39](#)
- "Available Image Aspect Ratios" [p.40](#)
- "Projected Image Appearance with Each Aspect Mode" [p.40](#)
- "Image Quality Settings - Image Menu" [p.61](#)

Changing the Image Aspect Ratio

You can change the aspect ratio of the displayed image.

- 1** Turn on the projector and display an image.
- 2** Press the  button on the remote control.

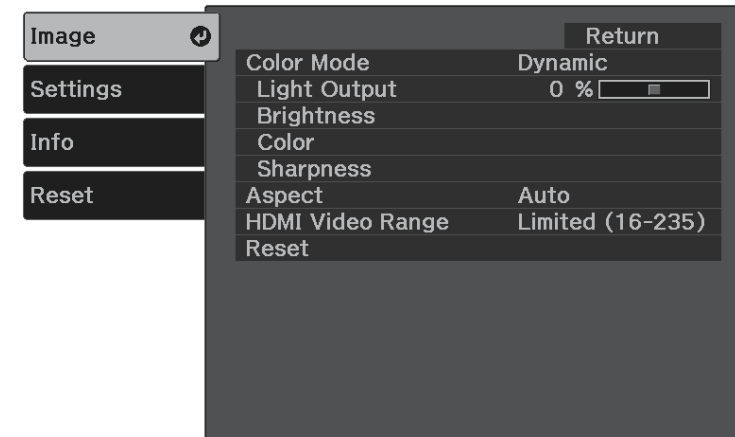

- 3** Select the **Image** menu and press .

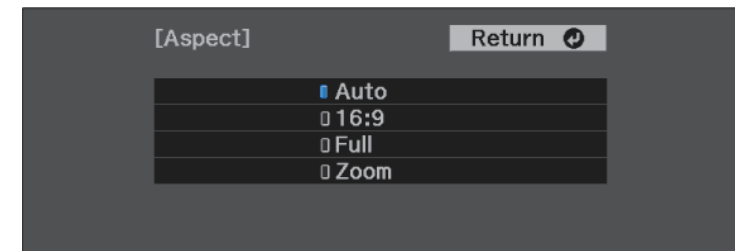

- 4** Select **Aspect** and press .

- 5** Select one of the available aspect ratios for your input signal and press .



- 6** Press  or  to exit the menus.

» Related Links

- "Image Quality Settings - Image Menu" [p.61](#)

Available Image Aspect Ratios

You can select the following image aspect ratios, depending on the input signal from your image source.



- Note that using the aspect ratio function of the projector to reduce, enlarge, or split the projected image for commercial purposes or for public viewing may infringe upon the rights of the copyright holder of that image based on copyright law.

Aspect mode	Aspect ratio for input signals		
	16:10	16:9	4:3
Full			
Zoom			

Aspect mode	Description
Auto	Automatically sets the aspect ratio according to the input signal.
16:9	Converts the aspect ratio of the image to 16:9.
Full	Displays images using the full size of the projection area, but does not maintain the aspect ratio.
Zoom	Displays images using the full width of the projection area and maintains the aspect ratio of the image.

Projected Image Appearance with Each Aspect Mode

Black bands and cropped images may project in certain aspect ratios, depending on the aspect ratio and resolution of your input signal. See the following table to confirm the position of black bands and cropped images.

Aspect mode	Aspect ratio for input signals		
	16:10	16:9	4:3
Auto			
16:9			



The projector offers different color modes to provide optimum brightness, contrast, and color for a variety of viewing environments and image types. You can select the mode designed to match your image and environment, or experiment with the available modes.

► **Related Links**





- "Changing the Color Mode" [p.41](#)
- "Available Color Modes" [p.41](#)
- "Turning On Automatic Luminance Adjustment" [p.41](#)

Changing the Color Mode

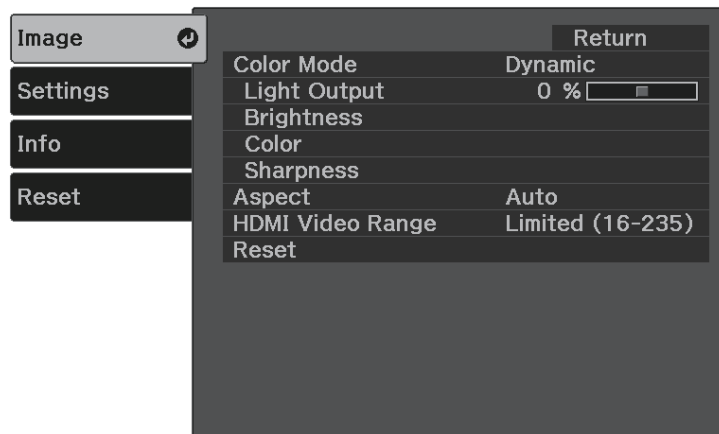
You can change the projector's Color Mode using the remote control to optimize the image for your viewing environment.

- 1 Turn on the projector and display an image.
- 2 Press the  button on the remote control.
- 3 Select the **Image** menu and press .



- 4 Select **Color Mode** and press .
- 5 Select the color mode you want to use from the list and press .
- 6 Press  or  to exit the menus.

► **Related Links**

- "Image Quality Settings - Image Menu" [p.61](#)

Available Color Modes

You can set the projector to use these color modes, depending on your environment and image types.

Color mode	Description
Dynamic	This is the brightest mode. Best for prioritizing brightness.
Bright Cinema	Best for projecting vivid images.
Natural	Best for adjusting the image color.
Cinema	Best for enjoying content such as movies.

Turning On Automatic Luminance Adjustment

You can turn on Dynamic Contrast to automatically optimize the image luminance. This improves the image contrast based on the brightness of the content you project.

This setting is available for **Dynamic** or **Cinema** color modes.

- 1 Turn on the projector and display an image.

2 Press the  button on the remote control.

3 Select the **Image** menu and press .

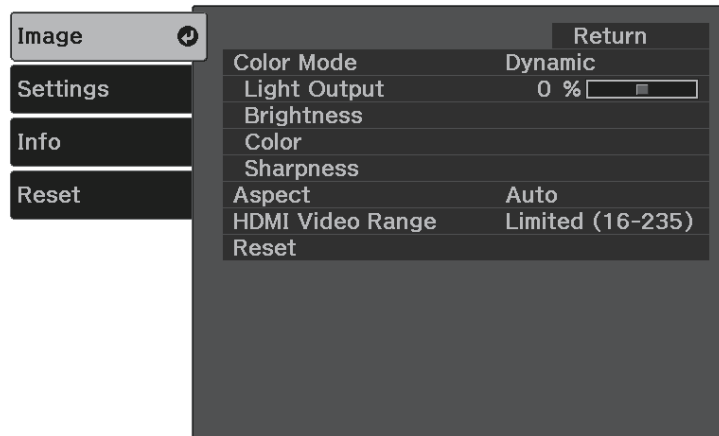

4 Select **Brightness > Dynamic Contrast** and press .

5 Select one of the following options and press .

- **Normal** for standard brightness adjustment.
- **High Speed** to adjust brightness as soon as the scene changes.

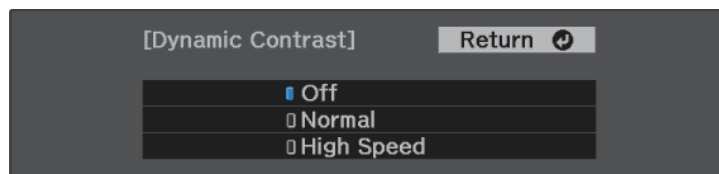

6 Press  or  to exit the menus.

You can fine-tune various aspects of the quality of your projected images.

1 Turn on the projector and display an image.

2 Press the  button on the remote control.

3 Select the **Image** menu and press .

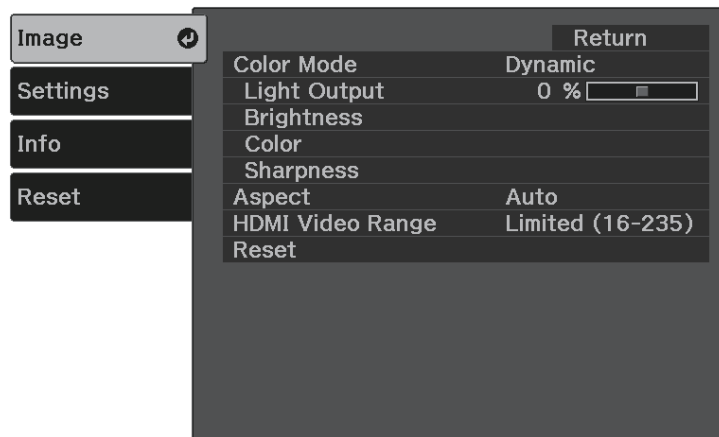



4 Select **Sharpness** and press .

5 Do the following as necessary for each setting:

- To adjust the outline of the image, adjust the **Sharpness** setting.
- To reduce flickering in images, adjust the **Noise Reduction** setting.

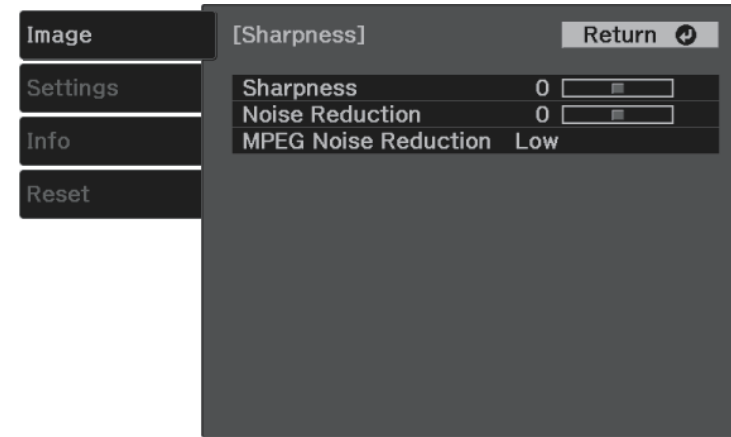
- To reduce flickering in MPEG images, adjust the **MPEG Noise Reduction** setting.



6 Press  or  to exit the menus.



You can fine-tune various aspects of how colors are displayed in your projected images.

► Related Links

- "Adjusting the Color Temperature" [p.44](#)
- "Adjusting the RGB Offset and Gain" [p.44](#)
- "Adjusting the Hue, Saturation, and Brightness" [p.45](#)
- "Adjusting the Gamma" [p.46](#)

Adjusting the Color Temperature

You can set the overall color tone by adjusting the **Color Temp.** setting if the image is too bluish or reddish.

- 1 Turn on the projector and display an image.
- 2 Press the  button on the remote control.
- 3 Select the **Image** menu and press .

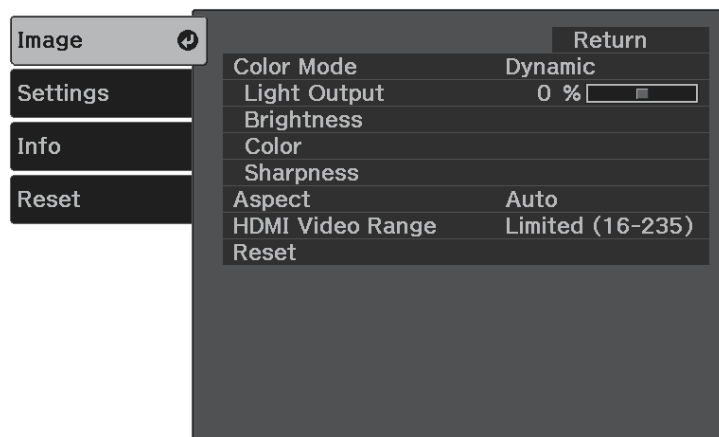

- 4 Select **Color > White Balance > Color Temp.** and press .
- 5 Press the left or right arrow button to adjust the color tone of the image.





Higher values tint the image blue and lower values tint the image red.

- 6 Press  or  to exit the menus.

Adjusting the RGB Offset and Gain

You can adjust the brightness of dark and bright areas by adjusting the **Offset** and **Gain** settings for individual image colors.

- 1 Turn on the projector and display an image.
- 2 Press the  button on the remote control.

3 Select the **Image** menu and press .

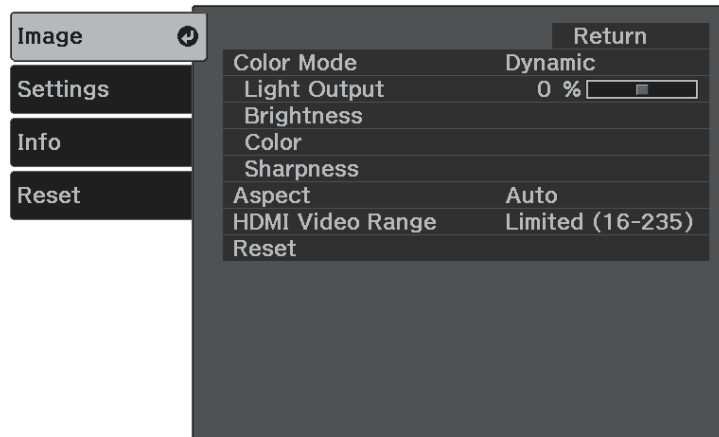

4 Select **Color > White Balance > Custom** and press .

5 Do the following as necessary for each R (red), G (green), and B (blue):

- To adjust the brightness of dark areas, adjust the **Offset** setting.
- To adjust the brightness of bright areas, adjust the **Gain** setting.

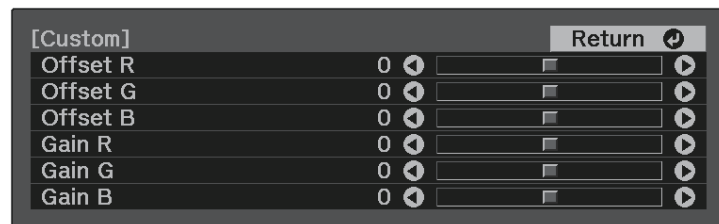

Higher values make the image brighter and lower values make the image darker.

In the **Offset** setting, shading for the dark areas is more vividly expressed when you select a high value. When you select a low value,

the image appears more full-bodied but shading for the dark areas is harder to distinguish.

In the **Gain** setting, the bright areas become whiter and shading is lost when you select a high value. When you select a low value, shading for the bright areas is more vividly expressed.

6 Press  or  to exit the menus.

Adjusting the Hue, Saturation, and Brightness

You can adjust the **Hue**, **Saturation**, and **Brightness** settings for individual image colors.

1 Turn on the projector and display an image.

2 Press the  button on the remote control.

3 Select the **Image** menu and press .

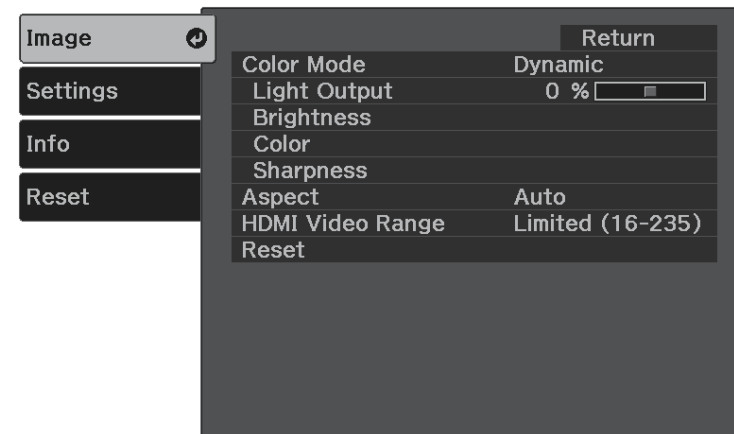



4 Select **Color > RGBCMY** and press .

5 Select the color to adjust, and press .



- 6** Do the following as necessary for each setting:
- To adjust the overall hue of the color, bluish - greenish - reddish, adjust the **Hue** setting.
 - To adjust the overall vividness of the color, adjust the **Saturation** setting.
 - To adjust the overall color brightness of the color, adjust the **Brightness** setting.



7 Press  or  to exit the menus.

Adjusting the Gamma

You can correct differences in projected image colors that occur between different image sources by adjusting the **Gamma** setting.

1 Turn on the projector and display an image.

2 Press the  button on the remote control.

3 Select the **Image** menu and press .

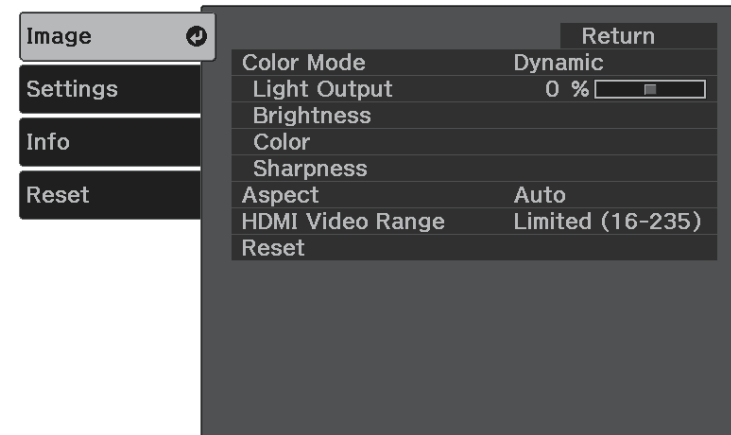

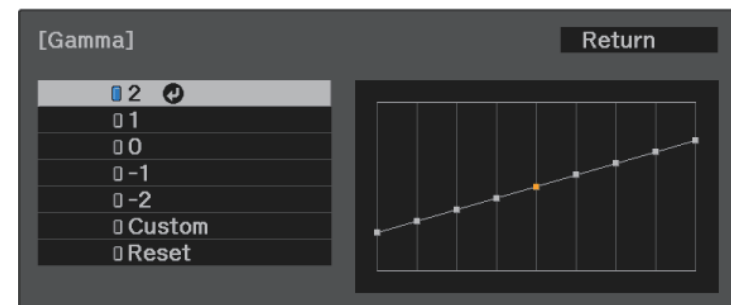

4 Select **Brightness > Gamma** and press .

5 Select and adjust the correction value.

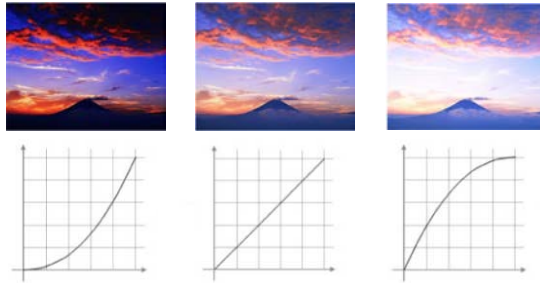

When you select a smaller value, you can reduce the overall brightness of the image to make the image sharper. When you select a larger value, the dark areas of images become brighter, but the color saturation for lighter areas may become weaker.





8 Press  or  to exit the menus.

6 If you want to make finer adjustments, select **Custom** and press .

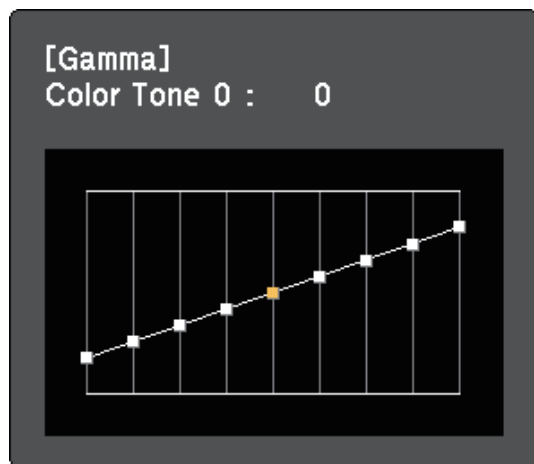
7 Press the left or right arrow buttons to select the color tone you want to adjust on the gamma adjustment graph. Then press the up or down arrow button to adjust the value and press .



You can adjust the brightness of your projector's light source.

- 1 Turn on the projector and display an image.
- 2 Press the  button on the remote control.
- 3 Select the **Image** menu and press .

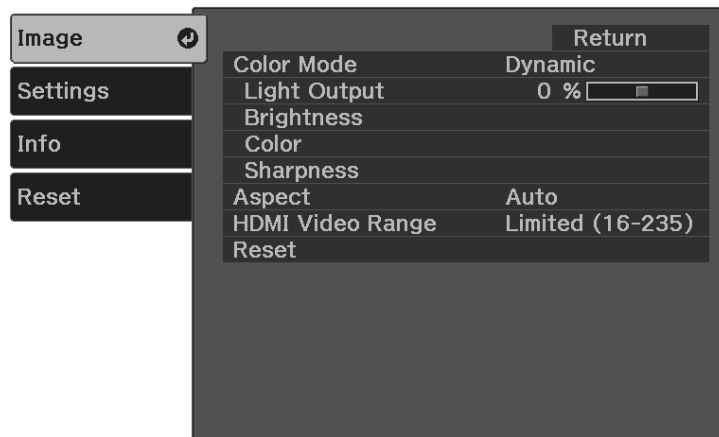

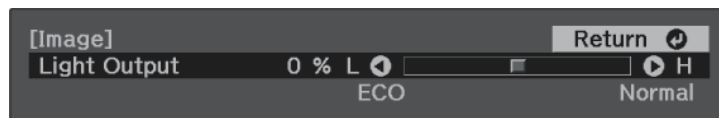

- 4 Select **Light Output** and press .
- 5 Press the left and right arrow buttons to select the brightness.



- 6 Press  or  to exit the menus.

You can save the customized **Image** menu settings for your video inputs and then select the saved settings whenever you want to use them.

- 1 Turn on the projector and display an image.
- 2 Press the  button on the remote control.
- 3 Select the **Settings** menu and press .

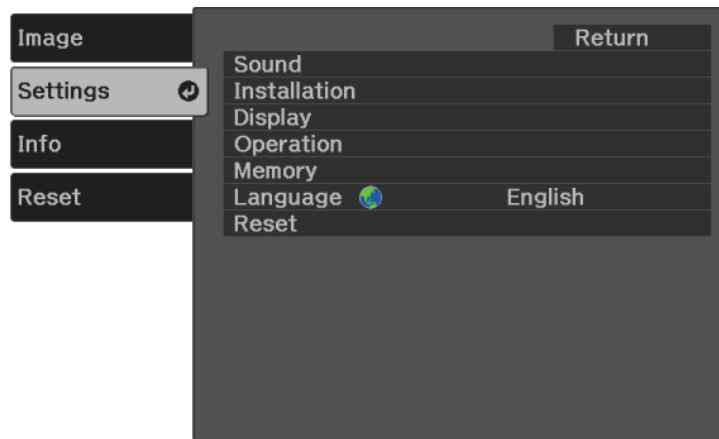

- 4 Select **Memory** and press .

- 5 Select one of the following options:

- **Load Memory** lets you overwrite your current **Image** menu settings with saved settings.
- **Save Memory** lets you save your current **Image** menu settings to memory (10 memories with different names are available).



A memory name that has already been used is indicated by a blue mark. Saving over a previously saved memory overwrites the settings with your current settings.

- **Erase Memory** lets you erase the selected memory settings.
- **Rename Memory** lets you rename a saved memory.

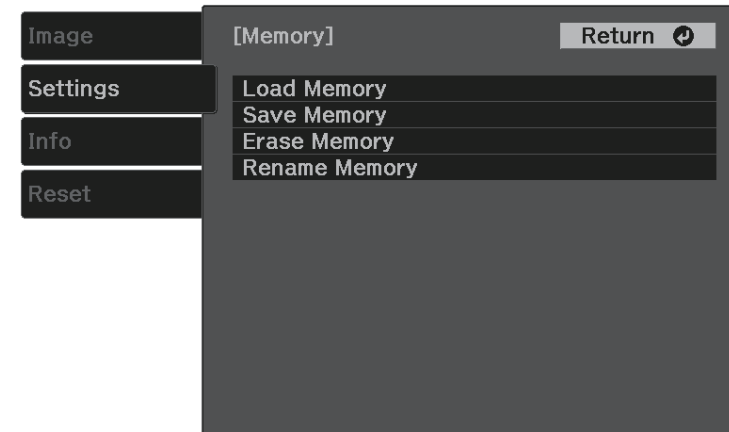

- 6 Press  or  to exit the menus.





- The saved Color Mode is displayed on the right of the memory name.
- To delete all saved memories, select **Reset Memory** in the projector's **Reset** menu.

The volume buttons control the projector's internal speaker system.

You can also control the volume for Bluetooth audio devices connected to the projector.

You must adjust the volume of the projector's internal speaker system and the Bluetooth audio devices separately.

- 1** Turn on the projector and start a video.
- 2** To lower or raise the volume, press the  or  button on the control panel or remote control.

A volume gauge appears on the screen.



If you have adjusted the volume for your streaming media player to the lowest level using the remote control for Android TV™, you cannot raise the volume using the projector remote control. Raise the volume using the remote control for Android TV™, and then adjust the volume again using the projector remote control.

Caution

Do not start a playback at a high volume setting. Sudden loud noises may cause hearing loss.

Always lower the volume before powering off, so that you can power on and then gradually increase the volume.

» Related Links

- "Projector Feature Settings - Settings Menu" [p.62](#)

The projector offers different sound modes to provide optimum sound for a variety of image types.

You can select the mode designed to match your image, or experiment with the available modes.

 **Sound Mode** is disabled when the audio is output from Bluetooth audio devices.

1 Turn on the projector and start a video.

2 Press the  button on the remote control.

3 Select the **Settings** menu and press .

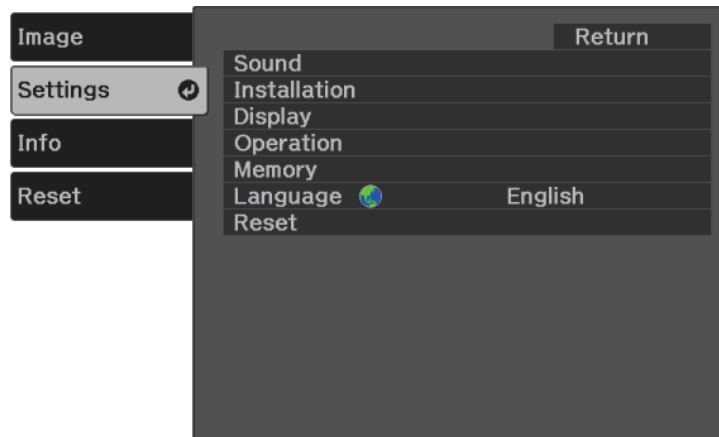

4 Select **Sound > Sound Mode** and press .

5 Select your sound mode and press .

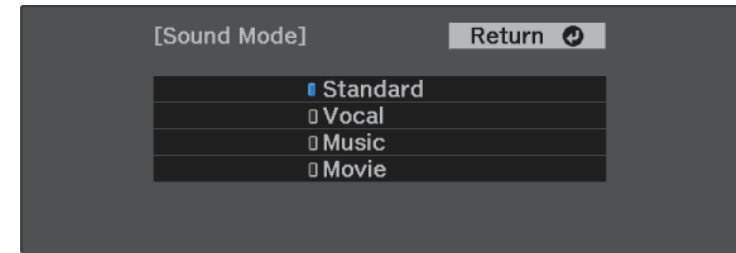

6 Press  or  to exit the menus.

» Related Links

- "Available Sound Modes" [p.51](#)

Available Sound Modes

You can set the projector to use these sound modes, depending on the input source you are using:

Sound mode	Description
Standard	Outputs the audio using normal sound quality.
Vocal	Best for hearing voices and spoken lines.
Music	Best for music. Low and high pitch sounds are clearer.
Movie	Best for audio from videos or movies. Low and high pitch sounds are emphasized.

Adjusting Projector Features

Follow the instructions in these sections to use your projector's adjustment features.

► **Related Links**

- "HDMI Link Features" [p.53](#)
- "Shutting Off the Image and Sound Temporarily (A/V Mute)" [p.55](#)
- "Projector Security Features" [p.56](#)

When an audio/video source that meets the HDMI CEC standard is connected to the projector's HDMI port, you can use the projector's remote control to control certain features of the linked device.

» **Related Links**

- "Operating the Connected Devices Using the HDMI Link Features" [p.53](#)

Operating the Connected Devices Using the HDMI Link Features

You can select the connected device that is available for HDMI Link and control the selected device using the HDMI Link features.



- You must also configure the connected device. See the documentation supplied with the device for more information.
- Some connected devices or functions of those devices may not operate properly even if they meet the HDMI CEC standard. See the documentation supplied with the device for more information.
- Use a cable that supports the HDMI standard.

1 Press the button on the remote control.

2 Select the **Settings** menu and press .

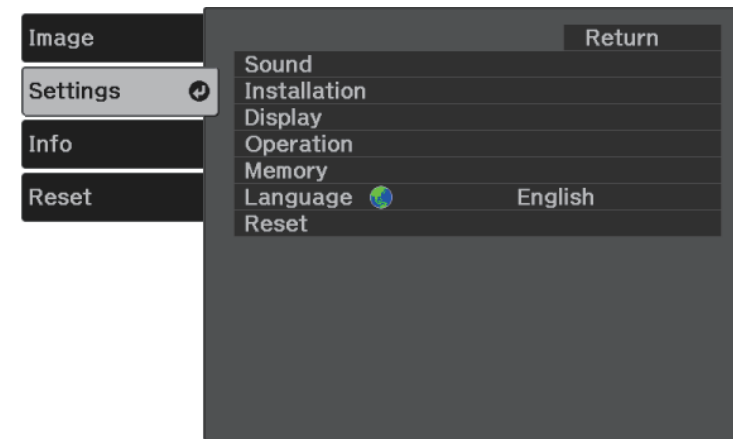

3 Select **Operation > HDMI Link** and press .

4 Select **On** as the **HDMI Link** setting and press .

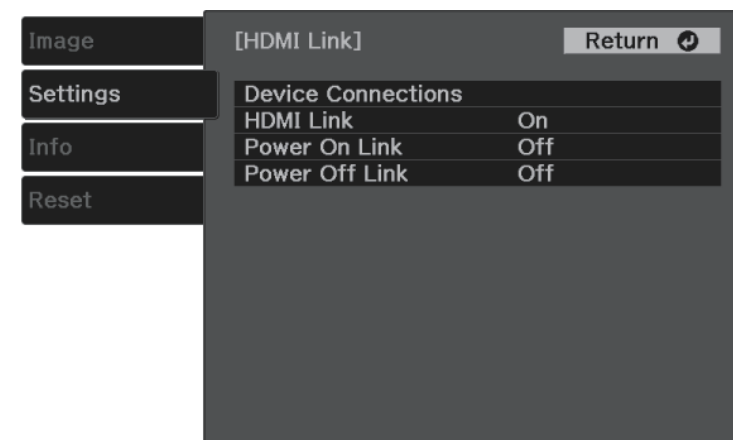

5 Select **Device Connections** and press .
You see the Device Connections list.

6 Select the device you want to control and project the image from, and press .

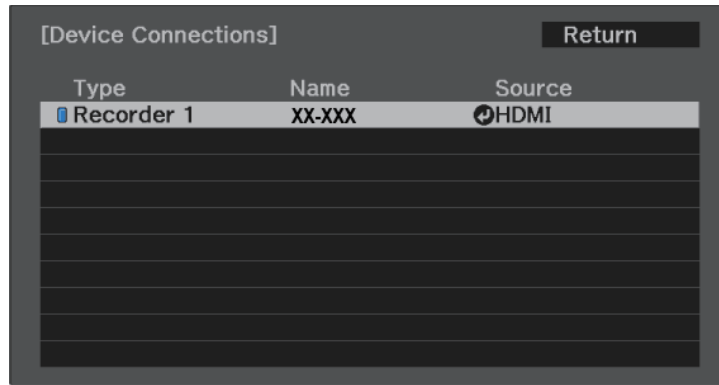



-  • A linked device is indicated by a blue mark.
- The device name is left blank if it cannot be acquired.

7 Press  to select the HDMI Link options as necessary.

- **Power On Link** lets you control what happens when you turn on the projector or linked device. Select **PJ -> Device** or **Bidirectional** to turn the linked device on when the projector is turned on. Select **Device -> PJ** or **Bidirectional** to turn the projector on when the linked device is turned on.
- **Power Off Link** lets you control whether linked devices are turned off when the projector is turned off.

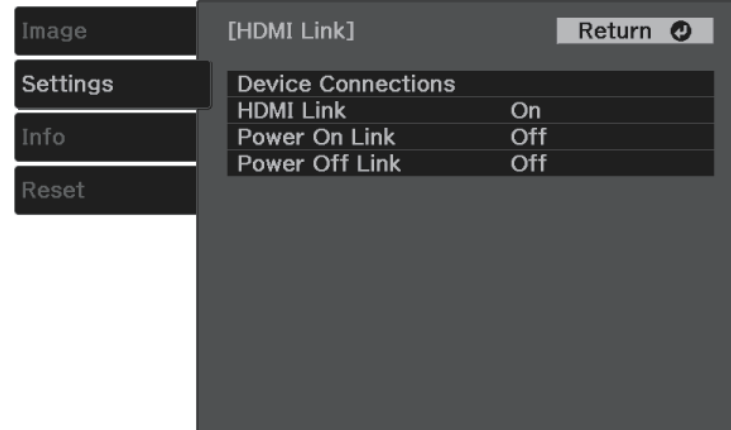
-  • **Power Off Link** only works when the connected device's CEC power link function is enabled.
- Note that depending on the status of the connected device (for example, if it is recording), the device may not be turned off.





8 Press  to exit the menus.

You can use the projector's remote control to control the linked device such as playback, stop, or adjust the volume.

- » **Related Links**
- "Projector Feature Settings - Settings Menu" [p.62](#)

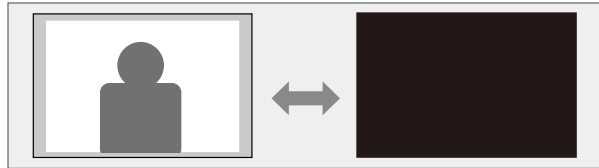
You can temporarily turn off the projected image and sound. Any sound or video action continues to run, however, so you cannot resume projection at the point that you stopped it.



- 1** Press the  button on the remote control.
The light source turns off and the projected image and sound are interrupted.
- 2** To turn the image and sound back on, press  again.

You can secure your projector to deter theft or prevent unintended use by setting up the following security features:

- Button lock security to block operation of the projector using the buttons on the control panel.
- Security cabling to physically secure the projector in place.

» Related Links

- "Locking the Projector's Buttons" [p.56](#)
- "Installing a Security Cable" [p.57](#)

Locking the Projector's Buttons

You can lock the buttons on the control panel to prevent anyone from using the projector. The projector can still be operated using the remote control.

1 Press the  button on the remote control.

2 Select the **Settings** menu and press .

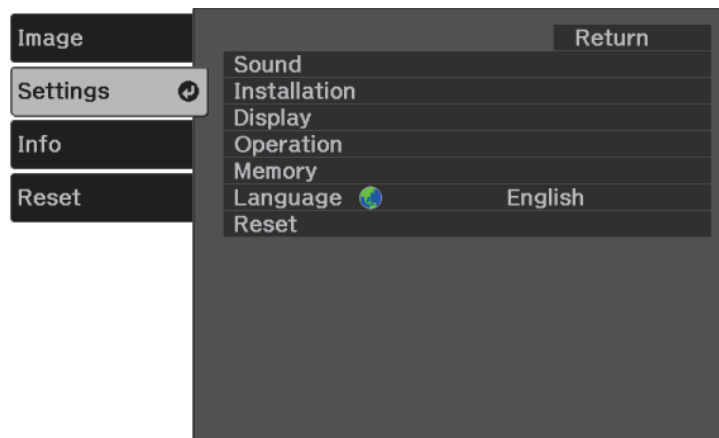

3 Select **Operation** and press .

4 Select one of these lock types and press .

- To lock the projector's power button, select **Child Lock**. To turn the projector on, you must press the power button for longer than three seconds.



Child Lock does not prevent the projector from turning on when the power cord is connected if the **Direct Power On** setting is set to **On**.

 **Settings > Operation > Direct Power On**

- To lock all of the projector's buttons, select **Control Panel Lock > Full Lock**.
- To lock all buttons except the power button, select **Control Panel Lock > Partial Lock**.

You see a confirmation prompt.

5 Select **Yes** and press .

» Related Links

- "Unlocking the Projector's Buttons" [p.56](#)
- "Projector Feature Settings - Settings Menu" [p.62](#)

Unlocking the Projector's Buttons

If the projector's buttons have been locked, do one of the following to unlock them.

- To release **Child Lock**, select **Off** as the **Child Lock** setting in the projector's **Settings** menu.

 **Settings > Operation > Child Lock**

- To release **Control Panel Lock**, hold down the  button on the control panel for seven seconds.

A message is displayed and the lock is released.

Installing a Security Cable

You can use the security slot on the projector to attach a Kensington Microsaver Security system as a theft deterrent.



For more details on the Microsaver Security System, see <http://www.kensington.com/>.

» Related Links

- "Projector Parts - Front/Top" [p.9](#)

Adjusting the Menu Settings

Follow the instructions in these sections to access the projector menu system and change projector settings.

► Related Links

- "Using the Projector's Menus" [p.59](#)
- "Using the Displayed Keyboard" [p.60](#)
- "Image Quality Settings - Image Menu" [p.61](#)
- "Projector Feature Settings - Settings Menu" [p.62](#)
- "Projector Information Display - Info Menu" [p.65](#)
- "Projector Reset Options - Reset Menu" [p.67](#)

You can use the projector's menus to adjust the settings that control how your projector works. The projector displays the menus on the screen.

1 Press the  button on the remote control.

You see the menu screen displaying the **Image** menu settings.

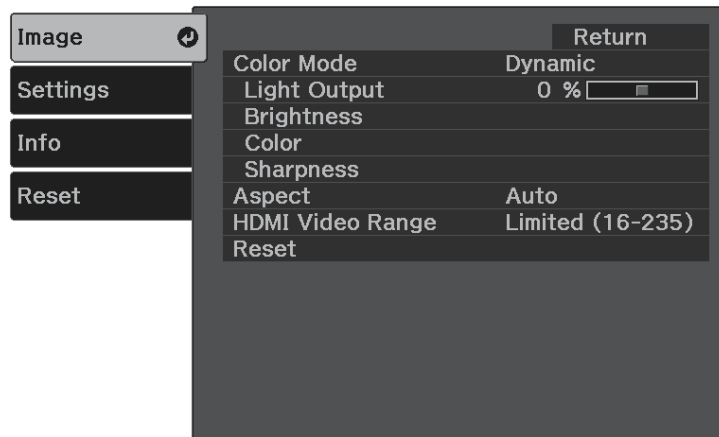

2 Press the up or down arrow buttons to move through the menus listed on the left. The settings for each menu are displayed on the right.

3 To change settings in the displayed menu, press .

4 Press the up or down arrow button to move through the settings.

5 Change the settings using the buttons listed on the bottom of the menu screens.

6 To return all the menu settings to their default values, select **Reset**.

7 When you finish changing settings on a menu, press .

8 Press  or  to exit the menus.

You can use the displayed keyboard to enter numbers and characters.

- 1 Use the arrow buttons on the remote control to highlight the number or character you want to enter and press the  button.

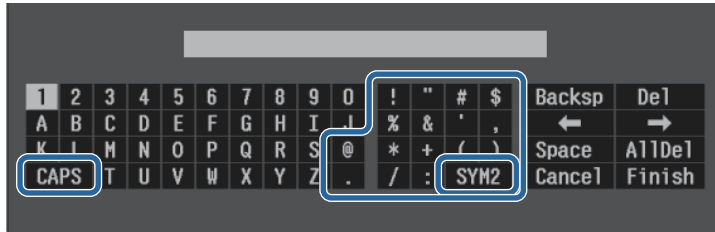

 Each time you select the **CAPS** key, the characters change between upper case and lower case. Each time you select the **SYM1/2** key, the symbols enclosed by the frame change.

- 2 After entering the text, select **Finish** on the keyboard to confirm your entries. Select **Cancel** to cancel entering text.

» **Related Links**

- "Available Text Using the Displayed Keyboard" [p.60](#)

Available Text Using the Displayed Keyboard

You can enter the following text when using the displayed keyboard.

Text type	Details
Symbols	!"#\$%&'()*+,-./:;<=>?@[\] ^_`{ }~

Text type	Details
Numbers	0123456789
Alphabet	ABCDEFGHIJKLMNOPQRSTUVWXYZ abcdefghijklmnopqrstuvwxyz

Settings on the **Image** menu let you adjust the quality of your image for the input source you are currently using.

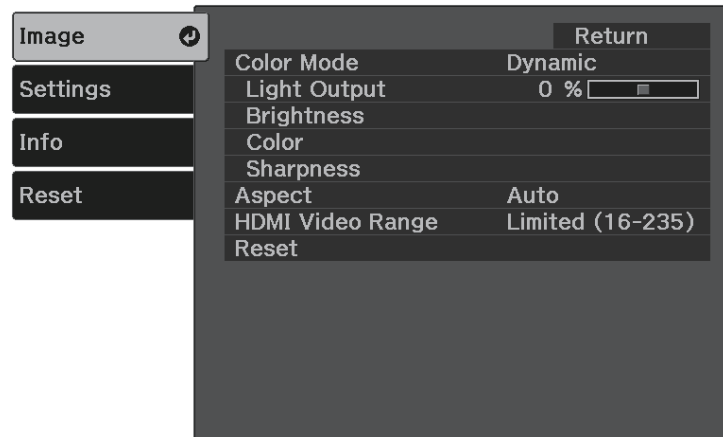

Setting	Options	Description
Color Mode	See the list of available color modes	Adjusts the vividness of image colors for various image types and environments.
Light Output	Varying levels available	Adjusts the brightness for the light source.
Brightness	Brightness	Lightens or darkens the overall image.
	Contrast	Adjusts the difference between light and dark areas of the image.
	Gamma	Adjusts the coloring by selecting one of the gamma correction values, or referring to a gamma graph.
	Dynamic Contrast	Adjusts the projected luminance based on the image brightness. (Available when Color Mode is set to Dynamic or Cinema .)
	EPSON Super White	Reduces over-exposure of whites in your image.

Setting	Options	Description
Color	Color Saturation	Adjusts the intensity of the image colors.
	Tint	Adjusts the balance of green to magenta tones in the image.
	White Balance	Color Temp.: Sets the color temperature according to the color mode you selected. Higher values tint the image blue and lower values tint the image red. Customized: Adjusts the individual R (red), G (green), and B (blue) components of the offset and gain.
	RGBCMY	Adjusts the hue, saturation, and brightness of each color R (red), G (green), B (blue), C (cyan), M (magenta), Y (yellow) individually.
Sharpness	Sharpness	Adjusts the sharpness or softness of image details.
	Noise Reduction	Reduces flickering in analog images.
	MPEG Noise Reduction	Reduces the noise or artifacts seen in MPEG video.
Aspect	See the list of available aspect ratios.	Sets the aspect ratio (width-to-height ratio) for the input source.
HDMI Video Range	Auto Limited (16-235) Full (0-255)	Sets the video range to match the setting of the device connected to the HDMI port.
Reset	—	Resets all adjustment values on the Image menu for the selected color mode to their default settings.

» **Related Links**

- "Available Color Modes" [p.41](#)
- "Projected Image Appearance with Each Aspect Mode" [p.40](#)
- "Adjusting the Light Source Brightness" [p.48](#)
- "Adjusting the Sharpness" [p.43](#)
- "Adjusting the Image Color" [p.44](#)

Options on the **Settings** menu let you customize various projector features.

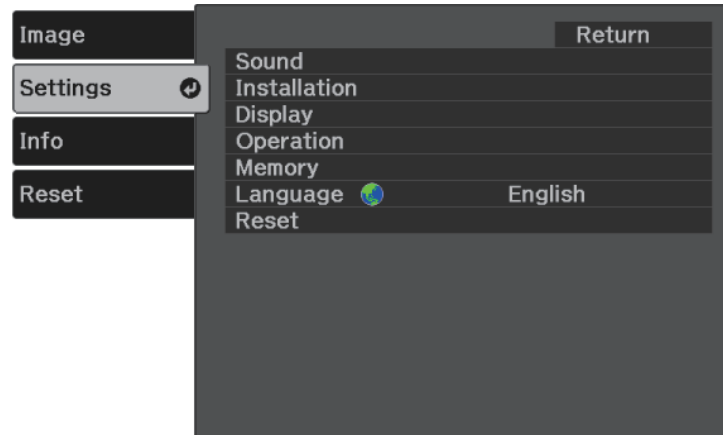

Setting	Options	Description
Sound	Volume	Adjusts the volume of the projector's speaker system. You can also control the volume for Bluetooth audio devices connected to the projector. Setting values are saved individually for each speaker.
	Sound Mode	Select your favorite mode for sound output from the projector's speaker system according to the playback contents. When outputting sound from Bluetooth audio devices, this item is disabled.
	Bluetooth	Search Bluetooth Device: searches for available Bluetooth devices and lists them. Bluetooth Audio: enables or disables audio output from Bluetooth audio devices. Connected Device: displays information on the connected Bluetooth device.

Setting	Options	Description
Installation	Keystone	H/V-Keystone: select to manually correct horizontal and vertical sides. Quick Corner: select to correct image shape and alignment using an on-screen display.
	Zoom	Adjusts the image size.
	Projection	Selects the way the projector faces the screen so the image is oriented correctly.
	OSD Rotation	Rotates the menu display 90°.
	High Altitude Mode	Regulates the projector's operating temperature at altitudes above 1500 m.
Display	Welcome Guide	Shows the Welcome Guide that presents product features and tips on how to use the projector.
	Messages	Set to On to display messages such as color mode name, aspect ratio, or high temperature warning on your projected image. Set to Off if you do not want to display messages.
	Startup Screen	Set to On to display the Epson logo when the projector starts up.
	Standby Confirmation	Set to Off to shut down the projector without displaying the shutdown confirmation screen when you press the power button on the control panel or remote control.
	Picture Demo Mode	Set to On to display images that have been pre-installed on the projector when there is no input signal. You can remove the images by pressing any key on the control panel or remote control. When you enable this item, the projector does not enter Sleep Mode.

Setting	Options	Description
Operation	HDMI Link	<p>Device Connections: lists the devices connected to the HDMI ports.</p> <p>HDMI Link: enables or disables the HDMI Link features.</p> <p>Power On Link: controls what happens when you turn on the projector or connected device.</p> <ul style="list-style-type: none"> • Bidirectional: automatically turns on the connected device when you turn on the projector, and vice versa. • Device -> PJ: automatically turns on the projector when you turn on the connected device. • PJ -> Device: automatically turns on the connected device when you turn on the projector. <p>Power Off Link: controls whether connected devices are turned off when you turn off the projector.</p>
	Sleep Mode	Automatically turns off the projector after an interval of inactivity (when On).
	Sleep Mode Timer	Sets the interval for Sleep Mode .
	Direct Power On	Lets you turn on the projector by plugging it in without pressing the power button.
	Illumination	Turns off the indicators on the projector.
	Child Lock	Locks the power button on the control panel in standby mode (when the power is off) to prevent children from turning on the projector.
	Control Panel Lock	Select Full Lock to lock all buttons or Partial Lock to lock all buttons except the power button.

Setting	Options	Description
	USB Power in Standby (For some countries and regions)	Set to On to power the streaming media player connected to the projector even if the projector is in standby mode (when the power is off). When the internal temperature of the projector gets too high, the power supply may stop automatically.
	Rear Bay Cooling	Selects the rotation speed of the cooling fan for the streaming media player.
Memory	Load Memory Save Memory Erase Memory Rename Memory	Save customized sets of settings to memory.
Language	Various languages available	Select the language for projector menu and message displays.
Reset	—	Resets all adjustment values on the Settings menu to their default settings, except for the following: <ul style="list-style-type: none"> • Zoom • Projection • High Altitude Mode • Power On Link • Power Off Link • USB Power in Standby • Rear Bay Cooling • Memory • Language

» **Related Links**

- "Image Shape" [p.33](#)
- "HDMI Link Features" [p.53](#)
- "Projector Security Features" [p.56](#)
- "Connecting to Bluetooth® Audio Devices" [p.23](#)
- "Saving Settings to Memory and Using Saved Settings" [p.49](#)

- "Controlling the Volume with the Volume Buttons" [p.50](#)
- "Changing the Sound Mode" [p.51](#)

You can display information about the projector and version by viewing the **Info** menu. However, you cannot change any settings in the menu.



Info Menu - Projector Info Menu

You can display information about the projector and input sources by viewing the **Projector Info** menu in the projector's **Info** menu.

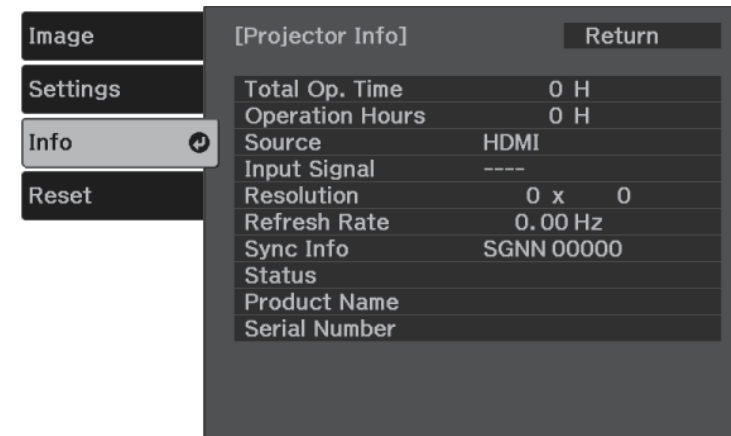

Information item	Description
Projector Info	Displays the projector information.
Light Source Info	Displays the number of operating hours for the projector's light source.
Version	Displays the projector's firmware version.

» Related Links

- "Info Menu - Projector Info Menu" [p.65](#)

Information item	Description
Total Op. Time	Displays the number of hours the projector has been used in its operating life.
Operation Hours	Displays the number of hours the projector has been used since it was turned on.
Source	Displays the name of the port to which the current input source is connected.
Input Signal	Displays the input signal setting of the current input source.
Resolution	Displays the resolution of the current input source.
Refresh Rate	Displays the refresh rate of the current input source.
Sync Info	Displays information that may be needed by a service technician.
Status	Displays information about projector problems that may be needed by a service technician.

Information item	Description
Product Name	Displays the projector's product name.
Serial Number	Displays the projector's serial number.

You can reset most of the projector settings to their default values using the **Reset** menu.

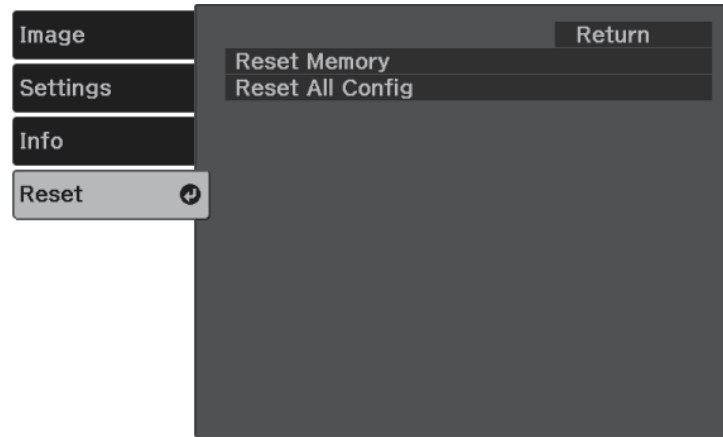

Setting	Options	Description
Reset Memory	—	Resets the name and settings of a saved memory.
Reset All Config	—	Resets most of the projector settings to their default values.

You cannot reset the following settings using the **Reset All Config** option:

- Zoom
- Memory
- Language

Maintaining the Projector

Follow the instructions in these sections to maintain your projector.

► **Related Links**

- "Projector Maintenance" [p.69](#)
- "Cleaning the Projection Window" [p.70](#)
- "Cleaning the Projector Case" [p.71](#)
- "Air Filter and Vent Maintenance" [p.72](#)

You may need to clean the projection window periodically, and clean the air filter and air vents to prevent the projector from overheating due to blocked ventilation.

The only parts you should replace are the air filter and remote control batteries. If any other part needs replacing, contact Epson or an authorized Epson servicer.

 **Warning**

Before cleaning any part of the projector, turn it off and unplug the power cord. Never open any cover on the projector, except as specifically explained in this manual. Dangerous electrical voltages in the projector can injure you severely.

Clean the projection window periodically, or whenever you notice dust or smudges on the surface. To remove dust or smudges, gently wipe the projection window with lens-cleaning paper.

 **Warning**

Do not use a lens cleaner that contains flammable gas. The high heat generated by the projector may cause a fire.

Attention

Do not use glass cleaner or any harsh materials to clean the projection window and do not subject the projection window to any impacts; otherwise, it could be damaged.

Before cleaning the projector case, turn off the projector and unplug the power cord.

- To remove dust or dirt, use a soft, dry, lint-free cloth.
- To remove stubborn dirt, use a soft cloth moistened with water and mild soap. Do not spray liquid directly on the projector.

Attention

Do not use wax, alcohol, benzene, paint thinner, or other chemicals to clean the projector case. These can damage the case. Do not use canned air, or the gases may leave a flammable residue.

Regular filter maintenance is important to maintaining your projector. Clean the air filter when a message appears telling you the temperature inside the projector has reached a high level. It is recommended that you clean these parts at least once every three months. Clean them more often than this if you use the projector in a particularly dusty environment.

Attention

If regular maintenance is not performed, your Epson projector will notify you when the temperature inside the projector has reached a high level. Do not wait until this warning appears to maintain your projector filter as prolonged exposure to high temperatures may reduce the life of your projector.

► Related Links

- "Cleaning the Air Filter and Vents" [p.72](#)
- "Replacing the Air Filter" [p.72](#)

Cleaning the Air Filter and Vents

Clean the projector's air filter or vents if they get dusty, or if you see a message telling you to clean them.

- 1** Turn off the projector and unplug the power cord.
- 2** Gently remove the dust using a small vacuum designed for computers or a very soft brush (such as a paintbrush).

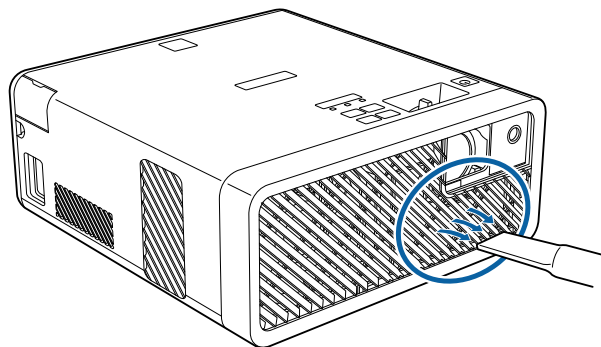

You can remove the air filter so that you can clean both sides. Do not rinse the air filter in water, or use any detergent or solvent to clean it.

Attention

Do not use canned air. The gases may leave a flammable residue or push dust and debris into the projector's optics or other sensitive areas.

- 3** If dust is difficult to remove or the air filter is damaged, replace the air filter.

Replacing the Air Filter

You need to replace the air filter in the following situations:

- After cleaning the air filter, you see a message telling you to clean or replace it.
- The air filter is torn or damaged.

You can replace the air filter while the projector is mounted to the ceiling or placed on a table.

- 1** Turn off the projector and unplug the power cord.
- 2** Turn the projector upside down.

3 Open the air filter cover.

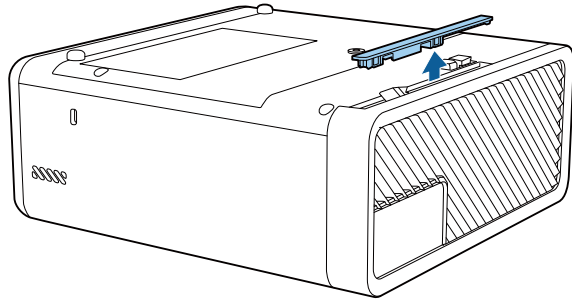

4 Pull the air filter out of the projector.

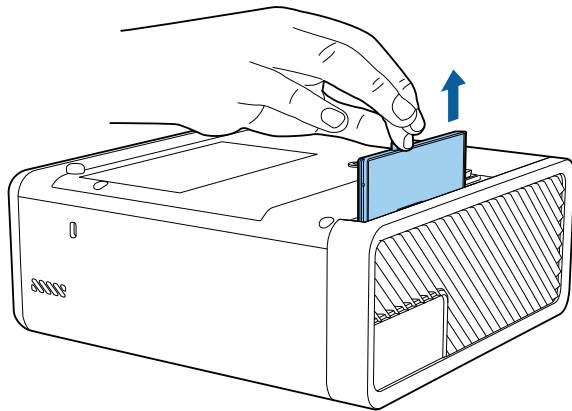

5 Place the new air filter in the projector as shown and push gently until it clicks into place.

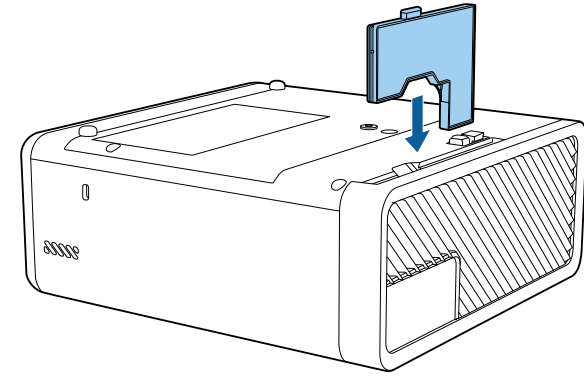

6 Close the air filter cover.

► **Related Links**

- "Replacement Parts" [p.88](#)



Dispose of used air filters according to local regulations.

- Filter frame: ABS
- Filter: Polyurethane foam

Solving Problems

Check the solutions in these sections if you have any problems using the projector.

► Related Links

- ["Projection Problems" p.75](#)
- ["Projector Indicator Status" p.76](#)
- ["Solving Projector Power-On or Power-Off Problems" p.78](#)
- ["Solving Image Problems" p.79](#)
- ["Solving Missing or Low Audio Problems" p.82](#)
- ["Solving Bluetooth Problems" p.83](#)
- ["Solving Remote Control Operation Problems" p.84](#)
- ["Solving HDMI Link Problems" p.85](#)
- ["Solving Epson Streaming Media Player Problems" p.86](#)

If the projector is not working properly, turn it off, unplug it, and then plug it back in and turn it on.

If this does not solve the problem, check the following:

- The indicators on the projector may indicate the problem.
- The solutions in this manual can help you solve many problems.

If none of these solutions help, contact Epson for technical support.

The indicators on the projector indicate the projector status and let you know when a problem occurs. Check the status and color of the indicators and then refer to this table for a solution.

 • If the indicators display a pattern not listed in the table below, turn the projector off, unplug it, and contact Epson for help.

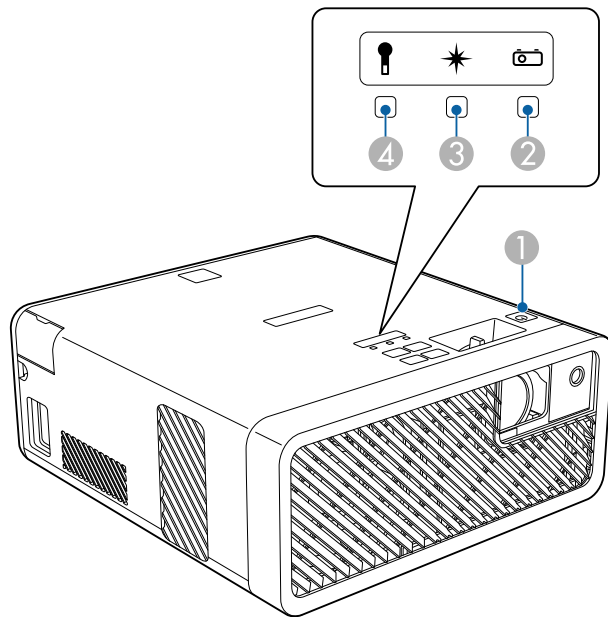

- ① On/Standby (power) indicator
- ② Status indicator
- ③ Laser indicator
- ④ Temp (temperature) indicator

Projector status

Indicator and status	Problem and solutions
Power: Lit blue Status: Lit blue Laser: Off Temp: Off	Normal operation.
Power: Lit blue Status: Flashing blue Laser: Off Temp: Off	Warming up, shutting down, or cooling down. When warming up, wait about 30 seconds for an image to appear. All buttons are disabled during warm-up, shutting down, and cooling down.
Power: Off Status: Off Laser: Off Temp: Off	Standby or sleep mode. When you press the power button, projection starts.
Power: Flashing blue Status: Off Laser: Off Temp: Off	Preparing to enter USB Power in Standby mode.
Power: Flashing blue Status: Indicator status varies Laser: Indicator status varies Temp: Flashing orange	Projector is too hot. <ul style="list-style-type: none"> • Make sure that the vents and air filter are not clogged with dust or obstructed by nearby objects. • Clean or replace the air filter. • Make sure the environmental temperature is not too hot.

Indicator and status	Problem and solutions
Power: Off Status: Flashing blue Laser: Off Temp: Lit orange	Projector has overheated and turned off. Leave it turned off to cool down for 5 minutes. <ul style="list-style-type: none"> • Make sure that the vents and air filter are not clogged with dust or obstructed by nearby objects. • Make sure the environmental temperature is not too hot. • Clean or replace the air filter. • If operating the projector at high altitude, set the High Altitude Mode setting to On in the projector's menu.  Settings > Installation > High Altitude Mode • If the problem persists, unplug the projector and contact Epson for help.
Power: Flashing blue Status: Indicator status varies Laser: Flashing orange Temp: Indicator status varies	Laser warning. Turn the projector off, unplug it, and contact Epson for help.
Power: Off Status: Flashing blue Laser: Lit orange Temp: Off	Laser has a problem. Turn the projector off, unplug it, and contact Epson for help.
Power: Off Status: Flashing blue Laser: Off Temp: Flashing orange	A fan or sensor has a problem. Turn the projector off, unplug it, and contact Epson for help.
Power: Off Status: Flashing blue Laser: Flashing orange Temp: Off	Internal projector error. Turn the projector off, unplug it, and contact Epson for help.

- "Replacing the Air Filter" [p.72](#)

» **Related Links**

- "Projector Feature Settings - Settings Menu" [p.62](#)
- "Cleaning the Air Filter and Vents" [p.72](#)

Check the solutions in these sections if the projector does not turn on when you press the power button or it turns off unexpectedly.

» Related Links

- "Solving Projector Power Problems" [p.78](#)
- "Solving Projector Shutdown Problems" [p.78](#)

Solving Projector Power Problems

If the projector does not turn on when you press the power button, try the following steps until the problem is solved.

- 1** Check the following items.
 - If you are using the remote control, check the batteries of the remote control.
 - Make sure the power cord is securely connected to the projector and to a working electrical outlet.
 - Check that you are not using the remote control for Android TV™. Make sure you are using the projector remote control.
- 2** Unlock the lock feature using the following method.
 - To release **Control Panel Lock**, hold down the  button on the control panel for seven seconds.
 - To release **Child Lock**, hold down the power button on the control panel for three seconds.
- 3** Disconnect the cord and contact Epson for help.

» Related Links

- "Projector Security Features" [p.56](#)

Solving Projector Shutdown Problems

If the projector's light source turns off unexpectedly, try the following steps until the problem is solved.

- 1** Projectors may have entered sleep mode after a period of inactivity. Perform any operation to wake the projector. To turn off sleep mode, select **Off** as the **Sleep Mode** setting.
 - ☛ **Settings > Operation > Sleep Mode**
- 2** When the status indicator is flashing, and the temp (temperature) indicator is lit, the projector has overheated and turned off.



The cooling fans may run in standby status depending on the projector settings. Also, when the projector wakes from standby status, the fans may cause an unexpected noise. This is not a malfunction.

» Related Links

- "Projector Feature Settings - Settings Menu" [p.62](#)

Check the solutions in these sections if you have any problems with projected images.

► Related Links

- "Solving Missing Image Problems" [p.79](#)
- "Adjusting an Image that is not Rectangular" [p.79](#)
- "Adjusting a Fuzzy or Blurry Image" [p.80](#)
- "Fixing Partial Image Problems" [p.80](#)
- "Adjusting an Image that Contains Noise or Static" [p.80](#)
- "Adjusting an Image with Incorrect Brightness or Colors" [p.81](#)
- "Adjusting an Upside-down Image" [p.81](#)

Solving Missing Image Problems

If no image is displayed, try the following steps until the problem is solved.

1 Check the projector's status:

- Press the  button on the remote control to see if the image was temporarily turned off.
- Check the status indicator to confirm that the projector is in normal operating status.
- Press the projector's power button to wake it from standby or sleep mode. Also, check if the connected computer is in sleep mode or displaying a blank screen saver.

☛ **Settings > Operation > Sleep Mode**

2 Check the cable connection:

- Make sure all necessary cables are securely connected and the power is on for the projector.
- Connect the video source directly to the projector.
- Replace the HDMI cable with the shorter one.

3 Check the status of your video source:

- If you are projecting from a streaming media player, make sure it is powered by the power supply USB cable on the projector.
- Turn on the connected streaming media player or video source, and press the play button to start a video, if necessary.
- Make sure the connected device meets the HDMI CEC standard. See the documentation supplied with the device for more information.
- If you are projecting from a laptop computer, make sure it is set up to display on an external monitor.

4 Check the following items:

- Turn off the projector and the connected streaming media player or video source, and then turn them back on.
- Set the CEC function for the connected device again and restart the device.
- Make sure the computer's display resolution does not exceed the projector's resolution and frequency limits. If necessary, select a different display resolution for your computer. (See your computer manual for details.)
- Resets all of the projector settings to their default values.

☛ **Reset > Reset All Config**

► Related Links

- "Projector Feature Settings - Settings Menu" [p.62](#)
- "Projector Reset Options - Reset Menu" [p.67](#)

Adjusting an Image that is not Rectangular

If the projected image is not evenly rectangular, try the following steps until the problem is solved.

- 1 Place the projector directly in front of the center of the screen, facing it squarely, if possible.

2 Adjust the image shape using the **Keystone** settings.

- ☛ **Settings > Keystone > H/V-Keystone**
- ☛ **Settings > Keystone > Quick Corner**

» Related Links

- "Projector Feature Settings - Settings Menu" [p.62](#)
- "Correcting the Image Shape with the Keystone Button" [p.34](#)
- "Correcting the Image Shape with Quick Corner" [p.35](#)

Adjusting a Fuzzy or Blurry Image

If the projected image is fuzzy or blurry, try the following steps until the problem is solved.

- 1** Adjust the image focus using the focus lever.
- 2** Check the following items:
 - Position the projector close enough to the screen.
 - Position the projector so the keystone adjustment angle is not so wide that it distorts the image.
- 3** Clean the projection window.



To avoid condensation on the lens after bringing the projector in from a cold environment, let the projector warm up to room temperature before using it.

- 4** Adjust the **Sharpness** setting in the projector's **Image** menu to improve image quality.
- 5** If you are projecting from a computer, use a lower resolution or select a resolution that matches the projector's native resolution.

» Related Links

- "Image Quality Settings - Image Menu" [p.61](#)
- "Focusing the Image Using the Focus Lever" [p.37](#)
- "Cleaning the Projection Window" [p.70](#)

Fixing Partial Image Problems

If only a partial computer image is displayed, try the following steps until the problem is solved.

- 1** If you zoomed into or out of the image using the **Zoom** setting, press the  button until the projector returns to a full display.
- 2** Make sure you selected the correct projection mode. You can select this using the **Projection** setting in the projector's **Settings** menu.
 - ☛ **Settings > Installation > Projection**
- 3** Check your computer display settings to disable dual display and set the resolution within the projector's limits. (See your computer manual for details.)

» Related Links

- "Projector Feature Settings - Settings Menu" [p.62](#)

Adjusting an Image that Contains Noise or Static

If the projected image contains electronic interference (noise) or static, try the following steps until the problem is solved.

- 1** Check the cables connecting your video source to the projector. They should be:
 - Separated from the power cord to prevent interference
 - Securely connected at both ends

- Not connected to an extension cable

- 2** If you adjusted the image shape using the projector controls, try decreasing the **Sharpness** setting in the projector's **Image** menu to improve image quality.
- 3** If you connected an extension power cable, try projecting without it to see if it caused interference in the signal.
- 4** Select a computer video resolution and refresh rate that are compatible with the projector.
- 5** If you connect using Bluetooth, try the following solutions:
 - Check for obstacles between the Bluetooth audio device and the projector, and change their positions to improve communication.
 - Make sure the connected Bluetooth audio device is within the specified communication distance.
 - Avoid using the projector near wireless networks, microwave ovens, 2.4 GHz cordless phones, or other devices that use the 2.4 GHz frequency band.

These devices can interfere with the signal between the projector and the Bluetooth audio device.

» Related Links

- "Image Quality Settings - Image Menu" [p.61](#)

Adjusting an Image with Incorrect Brightness or Colors

If the projected image is too dark or bright, or the colors are incorrect, try the following steps until the problem is solved.

- 1** Try different color modes for your image and environment by selecting the **Color Mode** setting in the projector's **Image** menu.

- 2** Check your video source settings.
- 3** Adjust the available settings in the projector's **Image** menu for the current input source, such as **Brightness**, **Contrast**, **Tint**, and **Color Saturation**.
 - ☛ **Image > Brightness**
 - ☛ **Image > Color**
- 4** Make sure you selected the correct **HDMI Video Range** setting in the projector's **Image** menu, if available for your image source.
 - ☛ **Image > HDMI Video Range**
- 5** Make sure all the cables are securely connected to the projector and your video equipment. If you connected long cables, try connecting shorter cables.
- 6** Position the projector close enough to the screen.

» Related Links

- "Image Quality Settings - Image Menu" [p.61](#)

Adjusting an Upside-down Image



If the projected image is upside-down, select the correct projection mode.

☛ **Settings > Installation > Projection**

» Related Links

- "Projector Feature Settings - Settings Menu" [p.62](#)

If there is no sound or the volume is too low, try the following steps until the problem is solved.

- 1** Adjust the projector's volume settings using the  or  button on the control panel or remote control.



If you have adjusted the volume for your streaming media player using the remote control for Android TV™, you may also need to adjust the volume again using the remote control for Android TV™.

- 2** Check the cable connection between the projector and your video source.
- 3** Check the following settings on the projector:
 - Press the  button on the remote control to resume video and audio if they were temporarily stopped.
 - Select **Off** as the **Bluetooth Audio** setting when you are using the projector's speaker or headphones.
 - Select **On** as the **Bluetooth Audio** setting when you are using a connected Bluetooth audio device.

☛ **Settings > Sound > Bluetooth > Bluetooth Audio**

- 4** Check the following settings on your video equipment:
 - Check your streaming media player or video source to make sure the volume is turned up and the audio output is set for the correct source.
 - Set the connected device to PCM output.
 - When you are connecting the projector to a Mac using an HDMI cable, make sure your Mac supports audio through the HDMI port.

- 5** If you connect using Bluetooth, try the following solutions:
 - Check for obstacles between the Bluetooth audio device and the projector, and change their positions to improve communication.
 - Make sure the connected Bluetooth audio device is within the specified communication distance.
 - Avoid using the projector near wireless networks, microwave ovens, 2.4 GHz cordless phones, or other devices that use the 2.4 GHz frequency band.

These devices can interfere with the signal between the projector and the Bluetooth audio device.

► **Related Links**

- "Projector Feature Settings - Settings Menu" [p.62](#)

If you cannot connect to a Bluetooth audio device, try the following solutions.

- 1** Make sure the connected Bluetooth audio device supports copyright protection (SCMS-T) and A2DP.
- 2** Select **Search Bluetooth Device** in the projector's **Settings** menu when you connect a Bluetooth audio device for the first time or change to another Bluetooth audio device.
 - ☛ **Settings > Sound > Bluetooth > Search Bluetooth Device**

» **Related Links**

- "Projector Feature Settings - Settings Menu" [p.62](#)

If the projector does not respond to remote control commands, try the following steps until the problem is solved.



If you lose the remote control, you can order another one from Epson.

- 1** Check that the remote control batteries are installed correctly and have power. If necessary, replace the batteries.
- 2** Check that you are not using the remote control for Android TV™. Make sure you are using the projector remote control.
- 3** Check to see if a button on the remote control is stuck down, causing it to enter sleep mode. Release the button to wake the remote control up.
- 4** If the image is projected from the projector, make sure you are operating the remote control within the reception angle and range of the projector.
- 5** Make sure the projector is not warming up or shutting down.
- 6** Strong fluorescent lighting, direct sunlight, or infrared device signals may be interfering with the projector's remote receivers. Dim the lights or move the projector away from the sun or interfering equipment.
- 7** The Epson streaming media player and the remote control may have been disconnected. Perform pairing again by holding down the  and right arrow buttons on the remote control at the same time for about seven seconds.

» Related Links

- "Remote Control Operation" [p.25](#)

If you cannot operate the connected devices using the HDMI Link features, try the following steps until the problem is solved.

- 1** Make sure the cable meets the HDMI CEC standard.
- 2** Make sure the connected device meets the HDMI CEC standard. See the documentation supplied with the device for more information.
- 3** Check if the device is available in the **Device Connections** list.
If the device does not appear in the **Device Connections** list, it does not meet the HDMI CEC standards. Connect a different device.
☛ **Settings > Operation > HDMI Link > Device Connections**
- 4** Check that all cables required for HDMI Link are securely connected.
- 5** Make sure the connected devices are turned on and in standby status. See the documentation supplied with the device for more information.
- 6** If you connect a new device or change the connection, set the CEC function for the connected device again and restart the device.

» Related Links

- "Projector Feature Settings - Settings Menu" [p.62](#)

If you cannot operate the Epson streaming media player, try the following steps until the problem is solved.

- 1** Make sure the streaming media player is securely connected to the projector.
- 2** You need an Internet connection to view online content. Make sure your Wi-Fi is on.
- 3** The Epson streaming media player and the remote control may have been disconnected. Perform pairing again by holding down the  and right arrow buttons on the remote control at the same time for about seven seconds.

Caution

The streaming media player supplied with your projector is designed for use with this projector. Depending on the connected display device, the streaming media player may not work correctly.



After repairing the streaming media player, Epson may return the device to you in its initial status. Make sure you make a note of the account information of each online service before you contact your local dealer or the nearest Epson repair center.

» Related Links

- "Connecting to a Streaming Media Player" [p.19](#)

Appendix

Check these sections for the technical specifications and important notices about your projector.

► **Related Links**

- "Optional Accessories and Replacement Parts" [p.88](#)
- "Screen Size and Projection Distance" [p.89](#)
- "Supported Monitor Display Resolutions" [p.91](#)
- "Projector Specifications" [p.92](#)
- "External Dimensions" [p.93](#)
- "List of Safety Symbols and Instructions" [p.94](#)
- "Laser Safety Information" [p.96](#)
- "Glossary" [p.98](#)
- "Notices" [p.99](#)

The following optional accessories and replacement parts are available. Please purchase these products as and when needed.

The following list of optional accessories and replacement parts is current as of: December 2018.

Details of accessories are subject to change without notice and availability may vary depending on the country of purchase.

► Related Links

- "Mounts" [p.88](#)
- "Replacement Parts" [p.88](#)

Mounts

Ceiling mount/Floor stand ELPMB60

Use when installing the projector on a ceiling, a wall, or a floor.

Lighting Track Mount ELPMB61

Use when installing the projector on a lighting track.



Special expertise is required to suspend the projector from a ceiling.
Contact Epson for help.

Replacement Parts

Air filter ELPAF57

Use as a replacement for used air filters.

Check the table here to determine how far to place the projector from the screen based on the size of the projected image.

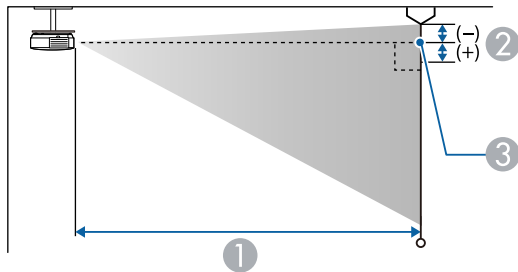
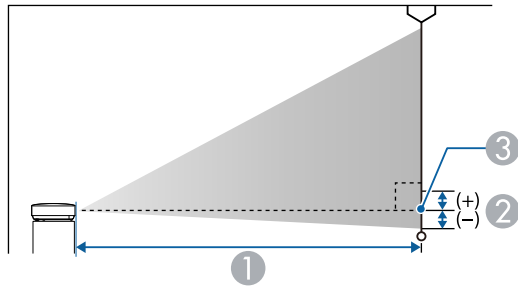

- ① Projection distance (cm)
- ② Distance from the center of the lens to the base of the screen (or to the top of the screen, if suspended from a ceiling) (cm)
- ③ Center of lens

16:10 screen size		①	②
		Minimum (Wide) to Maximum (Tele)	
60"	129 × 81	134 - 181	-7
80"	172 × 108	180 - 243	-10
90"	194 × 121	203 - 274	-11
100"	215 × 135	226 - 305	-12
120"	258 × 162	272 - 368	-15
130"	280 × 175	295 - 399	-16
150"	323 × 202	341 - 461	-18

4:3 screen size		①	②
		Minimum (Wide) to Maximum (Tele)	
30"	61 × 46	74 - 100	-4
40"	81 × 61	100 - 136	-6
50"	102 × 76	126 - 171	-7
60"	122 × 91	152 - 206	-8
70"	142 × 107	179 - 241	-10
80"	163 × 122	205 - 276	-11
90"	183 × 137	231 - 311	-12
100"	203 × 152	257 - 347	-14
110"	224 × 168	283 - 382	-15
120"	244 × 183	309 - 417	-17
130"	264 × 198	335 - 452	-18

16:10 screen size		①	②
		Minimum (Wide) to Maximum (Tele)	
30"	65 × 40	65 - 88	-4
40"	86 × 54	88 - 119	-5
50"	108 × 67	111 - 150	-6

16:9 screen size		①	②
		Minimum (Wide) to Maximum (Tele)	
30"	66 × 37	67 - 91	-2
40"	89 × 50	91 - 123	-2
50"	111 × 62	114 - 154	-3
60"	133 × 75	138 - 186	-3
70"	155 × 87	162 - 218	-4
80"	177 × 100	185 - 250	-5
90"	199 × 112	209 - 282	-5
100"	221 × 125	233 - 314	-6
110"	244 × 137	256 - 346	-6
120"	266 × 149	280 - 378	-7
130"	288 × 162	304 - 410	-7

Signal	Refresh rate (Hz)	Resolution (dots)
VGA	60	640 × 480
SDTV (480i/480p)	59.94	720 × 480
SDTV (576i/576p)	50	720 × 576
HDTV (720p)	50/59.94/60	1280 × 720
HDTV (1080i)	50/59.94/60	1920 × 1080
HDTV (1080p)	23.98/24/29.97/30/50/59.94/60	1920 × 1080

Product name	EF-100W Android TV™ edition/EF-100B Android TV™ edition
Dimensions	210 (W) × 88 (H) × 227 (D) mm (not including raised section)
LCD panel size	0.59"
Display method	Poly-silicon TFT active matrix
Resolution	1,024,000 pixels WXGA (1,280 (W) × 800 (H) dots) × 3
Focus adjustment	Manual
Zoom adjustment	1.0 to 1.35 (Digital Zoom)
Light source	Laser diode
Light source output power	Up to 43 W
Wavelength	449 to 461 nm
Light source life	Light Output 100%: Up to about 12,000 hours Light Output 50%: Up to about 20,000 hours
Max. audio output	5 W
Speaker	1
Power supply	100-240V AC±10% 50/60Hz 1.8 - 0.9 A
Power consumption (100 to 120 V area)	Operating power consumption: 178 W
Power consumption (220 to 240 V area)	Operating power consumption: 172 W
Standby power consumption	0.4 W
Operating altitude	Altitude 0 to 3,000 m
Operating temperature	Altitude of 0 to 2,286 m: 5 to +35°C (No condensation) Altitude of 2,287 to 3,000 m: 5 to +30°C (Humidity of 20 to 80%, No condensation)
Storage temperature	-10 to +60°C (Humidity of 10 to 90%, No condensation)
Mass	Approx. 2.7kg

This product is also designed for IT power distribution system with phase-to-phase voltage 230V.

► **Related Links**

- "Connector Specifications" [p.92](#)

Connector Specifications

Audio Out port	1	Stereo mini pin jack
HDMI port	1	HDMI (Audio is only supported by PCM)
USB-A port	1	USB connector (Type A)
Service port	1	USB connector (Type B)

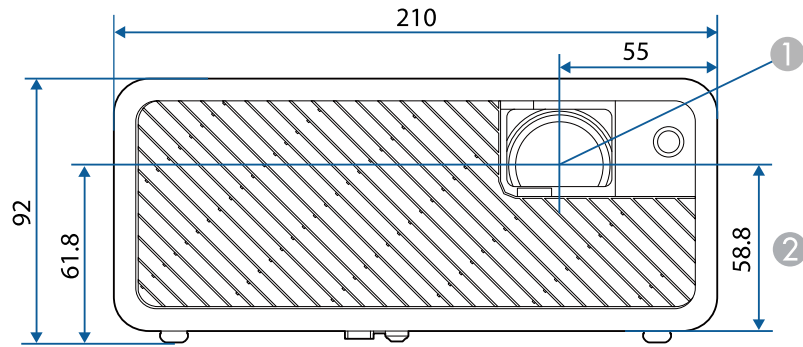





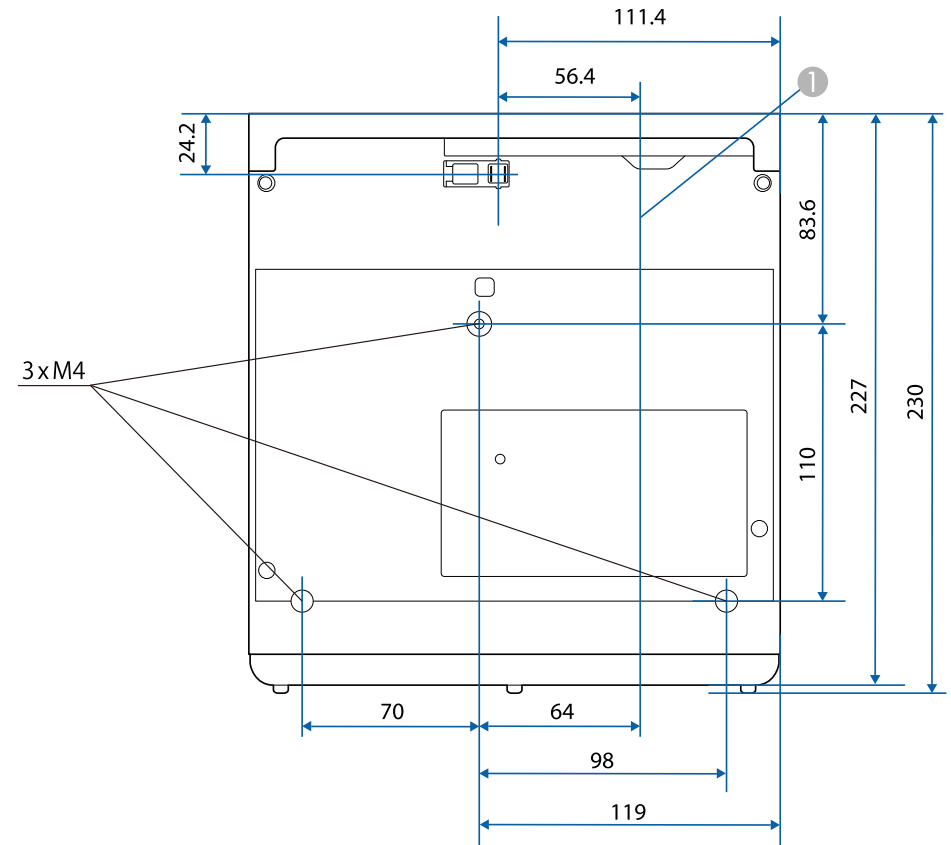



1 Center of lens









2 Distance from center of lens to suspension bracket fixing point













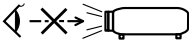

The unit in these illustrations is mm.

The following table lists the meaning of the safety symbols labeled on the equipment.

No.	Symbol mark	Approved standards	Description
1		IEC60417 No. 5007	"ON" (power) To indicate connection to the mains.
2		IEC60417 No. 5008	"OFF" (power) To indicate disconnection from the mains.
3		IEC60417 No. 5009	Stand-by To identify the switch or switch position by means of which part of the equipment is switched on in order to bring it into the stand-by condition.
4		ISO7000 No. 0434B, IEC3864-B3.1	Caution To identify general caution when using the product.
5		IEC60417 No. 5041	Caution, hot surface To indicate that the marked item can be hot and should not be touched without taking care.
6		IEC60417 No. 6042 ISO3864-B3.6	Caution, risk of electric shock To identify equipment that has risk of electric shock.
7		IEC60417 No. 5957	For indoor use only To identify electrical equipment designed primarily for indoor use.
8		IEC60417 No. 5926	Polarity of d.c. power connector To identify the positive and negative connections (the polarity) on a piece of equipment to which a d.c. power supply may be connected.

No.	Symbol mark	Approved standards	Description
9		—	The same as No. 8.
10		IEC60417 No. 5001B	Battery, general On battery powered equipment. To identify a device for instance a cover for the battery compartment, or the connector terminals.
11		IEC60417 No. 5002	Positioning of cell To identify the battery holder itself and to identify the positioning of the cell(s) inside the battery holder.
12		—	The same as No. 11.
13		IEC60417 No. 5019	Protective earth To identify any terminal which is intended for connection to an external conductor for protection against electric shock in case of a fault, or the terminal of a protective earth electrode.
14		IEC60417 No. 5017	Earth To identify an earth (ground) terminal in cases where neither the symbol No. 13 is explicitly required.
15		IEC60417 No. 5032	Alternating current To indicate on the rating plate that the equipment is suitable for alternating current only; to identify relevant terminals.
16		IEC60417 No. 5031	Direct current To indicate on the rating plate that the equipment is suitable for direct current only; to identify relevant terminals.

No.	Symbol mark	Approved standards	Description
17		IEC60417 No. 5172	Class II equipment To identify equipment meeting the safety requirements specified for Class II equipment according to IEC 61140.
18		ISO 3864	General prohibition To identify actions or operations that are prohibited.
19		ISO 3864	Contact prohibition To indicate injury that could occur due to touching a specific part of the equipment.
20		—	Never look into the optical lens while the projector is on.
21		—	To indicate that the marked item don't place anything on projector.
22		ISO3864 IEC60825-1	Caution, laser radiation To indicate the equipment has a laser radiation part.
23		ISO 3864	Disassembly prohibition To indicate a risk of injury, such as electric shock, if the equipment is disassembled.
24		IEC60417 No. 5266	Standby, partial standby To indicate that part of the equipment is in the ready status.
25		ISO3864 IEC60417 No. 5057	Caution, movable parts To indicate that you must keep away from movable parts according to protection standards.
26		IEC60417 No. 6056	Caution (Moving Fan Blades) As a safety precaution, stay away from the moving fan blades.

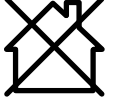
No.	Symbol mark	Approved standards	Description
27		IEC60417 No. 6043	Caution (Sharp Corners) To indicate sharp corners that should not be touched.
28		—	To indicate that looking into the lens while projecting is prohibited.
29		ISO7010 No. W027 ISO 3864	Warning, Optical radiation (such as UV, visible radiation, IR) Taking care to avoid injury to eyes and skin when in the vicinity of optical radiation.
30		IEC60417 No. 5109	Not to be used in residential areas. To identify electrical equipment which is not suitable for a residential area.

This projector is a Class 1 laser product that complies with the IEC/EN60825-1:2014 international standard for lasers. Follow these safety instructions when using the projector.

Warning

- Do not open the projector's case. The projector contains a high-powered laser.
- Possibly hazardous optical radiation emitted from this product. Do not look at operating light source. Eye injury may result.

Caution

Do not disassemble the projector when disposing of it. Dispose according to your local or national laws and regulations.



- The projector uses a laser as the light source. The laser has the following characteristics.
 - Depending on the surroundings, the brightness of the light source may decline. The brightness declines a lot when the temperature gets too high.
 - The brightness of the light source declines the longer it is used. You can change the relationship between usage time and decline in brightness settings.

Related Links

- "Laser Warning Labels" [p.96](#)

Laser Warning Labels

Laser warning labels are attached on the projector.

Inside



Side

As with any bright source, do not stare into the beam, RG2 IEC/EN 62471-5:2015.

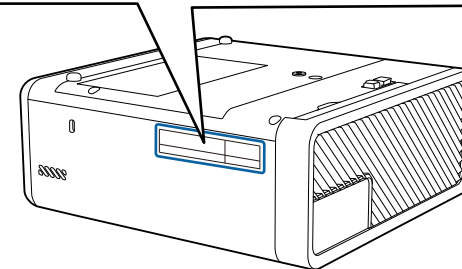
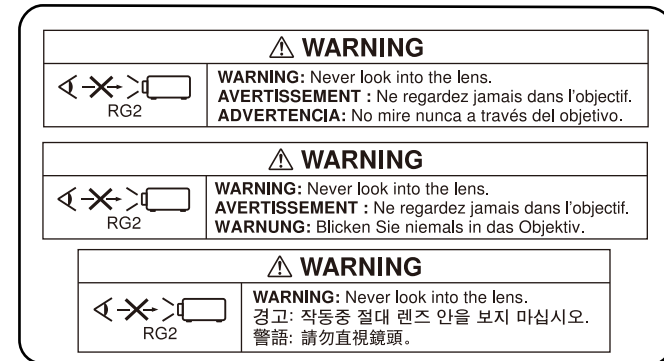

Base

For North/South America

This projector is a Class 2 laser product that complies with the IEC/EN60825-1:2007 international standard for lasers. Follow these safety instructions when using the projector.

Complies with FDA performance standards for laser products except for deviations pursuant to Laser Notice No. 50, dated June 24, 2007.

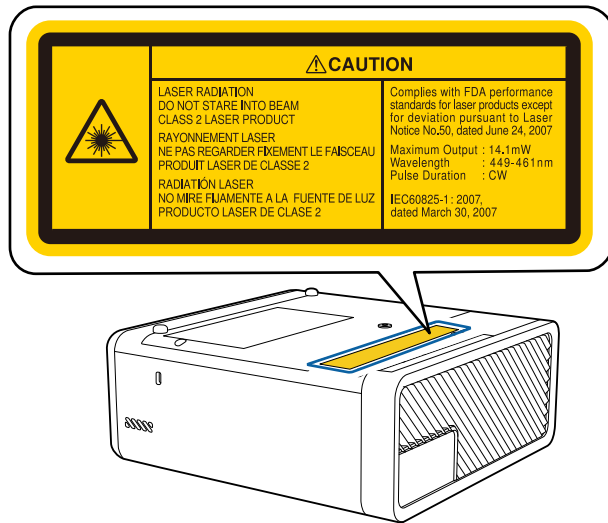

This section briefly explains the difficult terms that are not explained in the text of this guide. For details, refer to other commercially available publications.

Aspect Ratio	The ratio between an image's length and its height. Screens with a horizontal:vertical ratio of 16:9, such as HDTV screens, are known as wide screens. SDTV and general computer displays have an aspect ratio of 4:3.
Contrast	The relative brightness of the light and dark areas of an image can be increased or decreased to make text and graphics stand out more clearly, or to make them appear softer. Adjusting this particular property of an image is called contrast adjustment.
HDCP	HDCP is an abbreviation for High-bandwidth Digital Content Protection. It is used to prevent illegal copying and protect copyrights by encrypting digital signals sent over DVI and HDMI ports. Because the HDMI port on this projector supports HDCP, it can project digital images protected by HDCP technology. However, the projector may not be able to project images protected with updated or revised versions of HDCP encryption.
HDMI™	An abbreviation for High Definition Multimedia Interface. HDMI™ is a standard aimed at digital consumer electronics and computers. This is the standard by which HD images and multichannel audio signals are digitally transmitted. By not compressing the digital signal, the image can be transferred at the highest quality possible. It also provides an encryption function for the digital signal.
HDTV	An abbreviation for High-Definition Television that refers to high-definition systems which satisfy the following conditions: <ul style="list-style-type: none"> • Vertical resolution of 720p or 1080i or greater (p = Progressive, i = Interlace) • Screen aspect ratio of 16:9

Interlace	Transmits information needed to create one screen by sending every other line, starting from the top of the image and working down to the bottom. Images are more likely to flicker because one frame is displayed every other line.
Pairing	Register devices in advance when connecting with Bluetooth devices to ensure mutual communication.
Progressive	Projects information to create one screen at a time, displaying the image for one frame. Even though the number of scan lines is the same, the amount of flicker in images decreases because the volume of information has doubled compared with an interlace system.
Refresh Rate	The light-emitting element of a display maintains the same luminosity and color for an extremely short time. Because of this, the image must be scanned many times per second to refresh the light-emitting element. The number of refresh operations per second is called the Refresh rate and is expressed in hertz (Hz).
SDTV	An abbreviation for Standard Definition Television that refers to standard television systems which do not satisfy the conditions for HDTV High-Definition Television.
VGA	A screen size standard with a resolution of 640 (horizontal) × 480 (vertical) dots.
WXGA	A screen size standard with a resolution of 1,280 (horizontal) × 800 (vertical) dots.

Check these sections for important notices about your projector.

► **Related Links**

- "FCC Compliance Statement" [p.99](#)
- "Indication of the manufacturer and the importer in accordance with requirements of EU directive" [p.100](#)
- "Restriction of Use" [p.100](#)
- "Trademarks" [p.100](#)
- "Copyright Notice" [p.101](#)
- "Copyright Attribution" [p.101](#)

FCC Compliance Statement

Supplier's DECLARATION of CONFORMITY

According to 47CFR, Part 2 and 15

Class B Personal Computers and Peripherals; and/or

CPU Boards and Power Supplies used with Class B Personal Computers

We: Epson America, Inc.

Located at: 3840 Kilroy Airport Way Long Beach, CA 90806

Tel: 562-981-3840

Declare under sole responsibility that the product identified herein, complies with 47CFR Part 2 and 15 of the FCC rules as a Class B digital device. Each product marketed, is identical to the representative unit tested and found to be compliant with the standards. Records maintained continue to reflect the equipment being produced can be expected to be within the variation accepted, due to quantity production and testing on a statistical basis as required by 47CFR 2.906. Operation is subject to the following two conditions: (1) this device may not cause harmful interference, and (2) this device must accept any interface received, including interference that may cause undesired operation.

Trade Name: EPSON

Type of Product: Home Projector

Model: H914C

FCC Compliance Statement For United States Users

This device complies with part 15 of the FCC Rules. Operation is subject to the following two conditions: (1) This device may not cause harmful interference, and (2) this device must accept any interference received, including interference that may cause undesired operation.

This equipment has been tested and found to comply with the limits for a Class B digital device, pursuant to Part 15 of the FCC Rules. These limits are designed to provide reasonable protection against harmful interference in a residential installation. This equipment generates, uses, and can radiate radio frequency energy and, if not installed and used in accordance with the instructions, may cause harmful interference to radio communications. However, there is no guarantee that interference will not occur in a particular installation. If this equipment does cause interference to radio and television reception, which can be determined by turning the equipment off and on, the user is encouraged to try to correct the interference by one or more of the following measures.

- Reorient or relocate the receiving antenna.
- Increase the separation between the equipment and receiver.
- Connect the equipment into an outlet on a circuit different from that to which the receiver is connected.
- Consult the dealer or an experienced radio/TV technician for help.

WARNING

The connection of a non-shielded equipment interface cable to this equipment will invalidate the FCC Certification or Declaration of this device and may cause interference levels which exceed the limits established by the FCC for this equipment. It is the responsibility of the user to obtain and use a shielded equipment interface cable with this device. If this equipment has more than one interface connector, do not leave cables connected to unused interfaces. Changes or modifications not expressly approved by the manufacturer could void the user's authority to operate the equipment.

Indication of the manufacturer and the importer in accordance with requirements of EU directive

Manufacturer: SEIKO EPSON CORPORATION
Address: 3-5, Owa 3-chome, Suwa-shi, Nagano-ken 392-8502 Japan
Telephone: 81-266-52-3131
<http://www.epson.com/>

Importer: EPSON EUROPE B.V.
Address: Atlas Arena, Asia Building, Hoogoorddreef 5,1101 BA Amsterdam
Zuidoost
The Netherlands
Telephone: 31-20-314-5000
<http://www.epson.eu/>

Restriction of Use

When this product is used for applications requiring high reliability/safety such as transportation devices related to aviation, rail, marine, automotive etc.; disaster prevention devices; various safety devices etc; or functional/precision devices etc, you should use this product only after giving consideration to including fail-safes and redundancies into your design to maintain safety and total system reliability. Because this product was not intended for use in applications requiring extremely high reliability/safety such as aerospace equipment, main communication equipment, nuclear power control equipment, or medical equipment related to direct medical care etc, please make your own judgment on this product's suitability after a full evaluation.

Trademarks

EPSON is a registered trademark, EXCEED YOUR VISION, ELPLP and their logos are registered trademarks or trademarks of Seiko Epson Corporation.

Mac, Mac OS, OS X, and macOS are trademarks of Apple Inc.

Microsoft, Windows, Windows Vista, PowerPoint, and the Windows logo are trademarks or registered trademarks of Microsoft Corporation in the United States and/or other countries.

HDMI, the HDMI Logo and High-Definition Multimedia Interface are trademarks or registered trademarks of HDMI Licensing Administrator, Inc.



The Bluetooth® word mark and logo are registered trademarks of Bluetooth SIG, Inc., and the Seiko Epson Corporation uses these marks under license. Other trademarks or trade names are the property of their respective owners.

Bluetopia® is provided for your use by Stonestreet One, LLC® under a software license agreement. Stonestreet One, LLC® is and shall remain the sole owner of all right, title and interest whatsoever in and to Bluetopia® and your use is subject to such ownership and to the license agreement. Stonestreet One, LLC® reserves all rights related to Bluetopia® not expressly granted under the license agreement and no other rights or licenses are granted either directly or by implication, estoppel or otherwise, or under any patents, copyrights, mask works, trade secrets or other intellectual property rights of Stonestreet One, LLC®.

Qualcomm aptX is a product of Qualcomm Technologies, Inc. and/or its subsidiaries.

Qualcomm is a trademark of Qualcomm Incorporated, registered in the United States and other countries. aptX is a trademark of Qualcomm Technologies International, Ltd., registered in the United States and other countries.

©2000-2012 Stonestreet One, LLC® All Rights Reserved.

Adobe and Adobe Reader are either registered trademarks or trademarks of Adobe Systems Incorporated in the United States and/or other countries.

Wi-Fi™ is a trademark of the Wi-Fi Alliance.

Netflix is a registered trademark of Netflix, Inc. **NETFLIX**

Google, Android TV™, Chromecast, Google Assistant, YouTube, and Google Play are trademarks of Google LLC.

Other product names used herein are also for identification purposes only and may be trademarks of their respective owners. Epson disclaims any and all rights in those marks.

Copyright Notice

All rights reserved. No part of this publication may be reproduced, stored in a retrieval system, or transmitted in any form or by any means, electronic, mechanical, photocopying, recording, or otherwise, without the prior written permission of Seiko Epson Corporation. No patent liability is assumed with respect to the use of the information contained herein. Neither is any liability assumed for damages resulting from the use of the information contained herein.

Neither Seiko Epson Corporation nor its affiliates shall be liable to the purchaser of this product or third parties for damages, losses, costs, or expenses incurred by the purchaser or third parties as a result of: accident, misuse, or abuse of this product or unauthorized modifications, repairs, or alterations to this product, or (excluding the U.S.) failure to strictly comply with Seiko Epson Corporation's operating and maintenance instructions.

Seiko Epson Corporation shall not be liable against any damages or problems arising from the use of any options or any consumable products other than those designated as Original Epson Products or Epson Approved Products by Seiko Epson Corporation.

The contents of this guide may be changed or updated without further notice.

Illustrations in this guide and the actual projector may differ.

Copyright Attribution

This information is subject to change without notice.

©SEIKO EPSON CORPORATION 2019. All rights reserved.

2019.8 413868600EN