

User's Guide

EH-LS500W

EH-LS500B

Home Projector

Using Each Guide

The guides for this projector are organized as shown below.

Safety Instructions/Support and Service Guide

Contains information on using the projector safely, as well as a support and service guide, troubleshooting check lists, and so on. Make sure you read this guide before using the projector.



User's Guide (this guide)

Contains information on setting up and basic operations before using the projector, using the Configuration menu, and handling problems and performing routine maintenance.



Quick Start Guide

Contains information on the procedures for setting up the projector. Read this first.

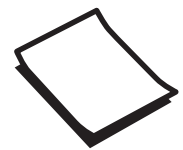

Notations Used in This Guide

Safety Indications

The documentation and the projector use graphical symbols to show how to use the projector safely. The following shows the symbols and their meanings. Please understand and respect these caution symbols in order to avoid injury to persons or property.

 **Warning**

This symbol indicates information that, if ignored, could possibly result in personal injury or even death due to incorrect handling.



 **Caution**

This symbol indicates information that, if ignored, could possibly result in personal injury or physical damage due to incorrect handling.

General Information Indications

Attention

Indicates procedures which may result in damage or malfunctions to occur.

	Indicates additional information and points which may be useful to know regarding a topic.
	Indicates a page where detailed information regarding a topic can be found.
Menu Name	Indicates Configuration menu items. Example: Image - Color Mode
[Hardware Names]	Indicates the buttons on the remote control or the control panel. Example: [Menu] button

About the Use of "This Product" or "This Projector"

As well as the main projector unit, supplied items or optional extras may be referred to using the phrase "this product" or "this projector".

Organization of the Guide and Notations in the Guide

Using Each Guide	1
Notations Used in This Guide	2
Safety Indications	2
General Information Indications	2
About the Use of "This Product" or "This Projector"	2

Introduction

Projector Features	6
Project Large Images Even when Near a Wall	6
Project Images from Mobile Devices	6
Other Useful Functions	6
Part Names and Functions	7
Front/Top	7
Rear/Top	8
Connector Ports	9
Base	10
Control Panel	11
Remote Control	12

Preparing

Installing	14
Projected Image and Position of Projector	14
Installing in parallel with the screen	14
Installing the projector horizontally by adjusting the height of either side	15
Precautions on Installation	16
Screen Size and Projection Distance	17
Connecting a Device	18
Connecting a Streaming Media Player	18
Connecting Video Equipment	20
Connecting a Computer	20
Connecting to the LAN Port	20
Attaching the Wireless LAN Unit	21
Connecting External Speakers	21
Connecting an ARC Compatible AV System	22
Preparing the Remote Control	23
Installing the Remote Control Batteries	23

Remote Control Operating Range	23
Operating range (left to right)	23
Operating range (top to bottom)	23

Basic Operations

Projecting Images	24
Turning On the Projector	24
If the target image is not projected	25
Using the Home Screen	26
Turning Off	27
Adjusting the Projected Image	28
Adjusting the Focus	28
Adjusting the Projection Size (Adjust Zoom)	28
Adjusting the Position of the Image (Image Shift)	29
Correcting Vertical Distortion in the Image	29
Correcting Keystone Distortion	30
Correct using the Keystone buttons	30
Correcting with Quick Corner	31
Adjusting the Volume	32
Hiding the Image and Muting the Audio Temporarily (A/V Mute)	32

Adjusting the Image

Adjusting the Image	33
Selecting the Projection Quality (Color Mode)	33
Switching the Screen Between Full and Zoom (Aspect)	33
Adjusting the Sharpness	35
Adjusting Image Resolution (Image Enhancement)	36
Adjusting the Luminance for Images	37
Setting Frame Interpolation	37
Setting the Image Processing Speed	38
Adjusting the Color	39
Adjusting the Color Temp.	39
Adjusting the RGB (Offset and Gain)	39
Adjusting Hue, Saturation, and Brightness	40
Adjusting the Gamma	41
Select and adjust the correction value	41
Adjust using the gamma adjustment graph	42

Viewing the Image at the Saved Image Quality (Memory Function) 43

- Saving a Memory 43
- Loading, Deleting, and Renaming a Memory 44

Useful Functions

Enjoying 3D Images 45

- Preparing to View 3D Images 45
 - If the 3D image cannot be viewed 45
- Using 3D Glasses 46
- Warnings Regarding Viewing 3D Images 46

Using the HDMI Link Function 48

- HDMI Link Function 48
- HDMI Link Settings 48
- Connecting 49

Using the Projector on a Network

Projecting Using Wired LAN 50

- Selecting Wired Network Settings 50

Projecting Using Wireless LAN 52

- Selecting Wireless Network Settings Manually 52
- Selecting the Computer's Wireless LAN Settings 55
 - Selecting wireless network settings in Windows 55
 - Selecting wireless network settings in OS X 55
- Setting Up Wireless Network Security 55
- Projecting in Epson iProjection (iOS/Android) 56
 - Operating using a smartphone (remote control function) 57

Configuration Menu

Configuration Menu Functions 59

- Configuration Menu Operations 59
- Configuration Menu Table 60
 - Image menu 60
 - Signal menu 62
 - Settings menu 63
 - Extended menu 65
 - Network menu 68
 - Info menu 72

- Reset menu 72

Troubleshooting

Problem Solving 73

- Handling Problems 73
- Reading the Indicators 73
 - Indicator status during an error/warning 74
 - Indicator status during normal operation 75
- When the Indicators Provide No Help 76
 - Check the problem 76
 - Problems relating to images 77
 - Noise problems 80
 - Problems when projection starts 80
 - Problems with the remote control 81
 - Problems with the control panel 81
 - Problems with 3D 81
 - Problems with HDMI 82
 - Problems with a streaming media player 83
 - Network problems 83
 - About Event ID 85

Maintenance

Maintenance 86

- Cleaning the Parts 86
 - Cleaning the air filter 86
 - Cleaning the main unit 88
 - Cleaning the lens 88
- Replacement Periods for Consumables 88
 - Air filter replacement period 88
- Replacing Consumables 88
 - Replacing the air filter 88

Panel Alignment 90

Color Uniformity 92

About PJLink 94

Appendix

Optional Accessories and Consumables 95

- Optional Items 95
- Consumables 95

Supported Resolutions	96
PC	96
Unique Aspect	96
SD	96
HD	97
4K	97
3D	98
Specifications	101
EH-LS500W/EH-LS500B	101
Appearance	104
List of Safety Symbols	105
Safety Instructions for Laser Products	107
Laser Warning Labels	108
Glossary	109
General Notes	110
General Notice	111

Projector Features

Project Large Images Even when Near a Wall

Take advantage of the projector's ultra-short throw lens to enjoy the full force of a projected image up on your wall instead of using a TV.

 [p.14](#)

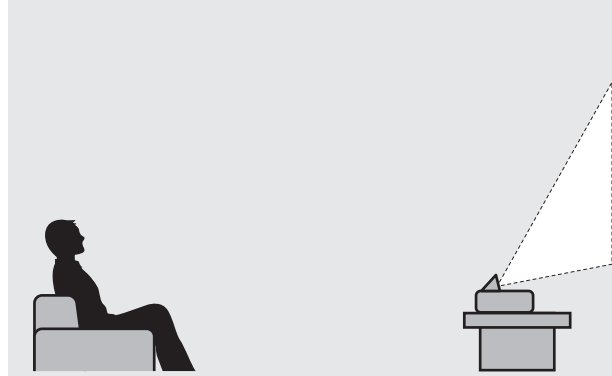

Project Images from Mobile Devices

By using Epson iProjection, you can wirelessly connect the projector to smartphones and tablets. You can download Epson iProjection for free from the App Store or from Google Play.

 [p.56](#)



Other Useful Functions

In addition, the following useful functions are provided.

- Playing audio through the internal speaker. This allows you to enjoy audio without an external speaker.
- Operate by remote control from a smartphone. By using Epson iProjection, you can operate the projector from a smartphone or tablet.  [p.57](#)

Part Names and Functions

Front/Top

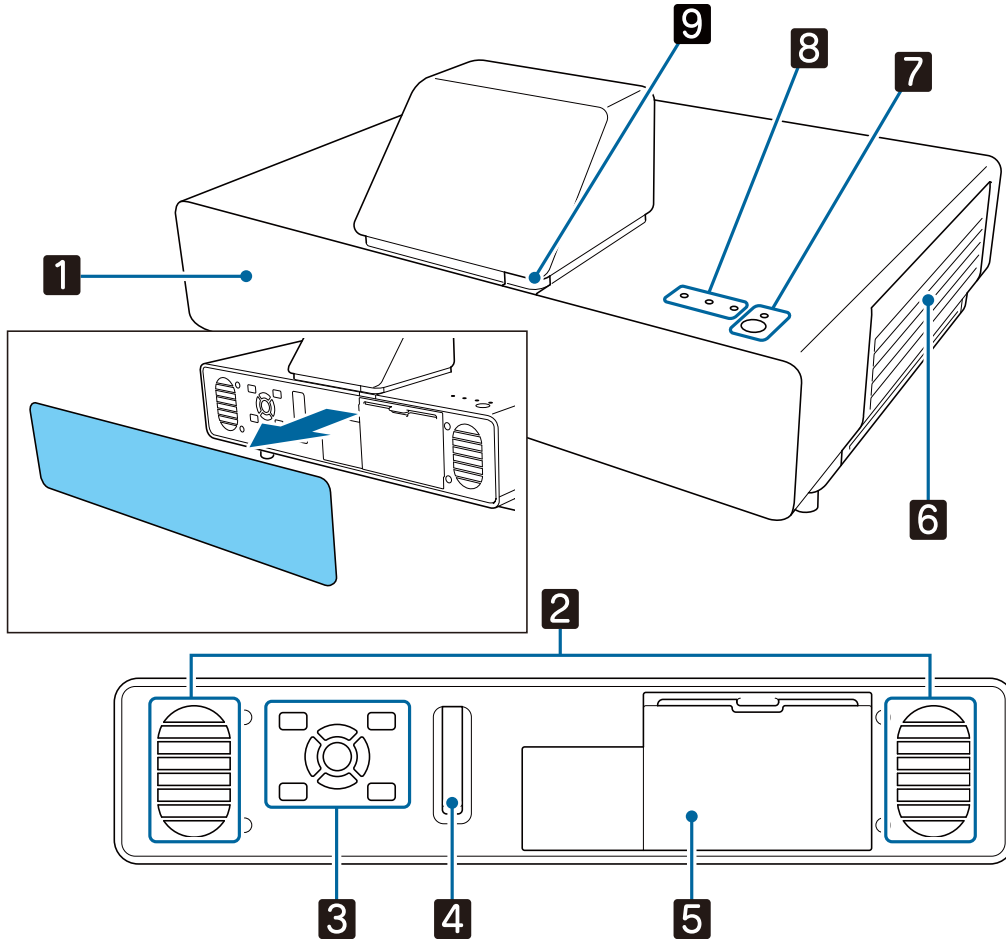

Name		Function
1	Front cover	Remove the cover when connecting a streaming media player and when operating the control panel and focus lever.
2	Speaker	The projector's built-in speaker. Outputs audio.
3	Control panel	Operates the projector. p.11
4	Focus lever	Adjusts the image focus. p.28
5	Storage space cover	Remove the cover when connecting a streaming media player. p.18
6	Air filter cover	When cleaning or replacing the air filter, open this cover and remove the air filter. p.86 , p.88
	Air intake vent	Intake vent for air used to cool the projector internally.
7	Standby button (Standby indicator)	Turns the projector on or off. p.24 Lit when the projector is on. Shows the projector's status through a combination of other indicators lit and flashing. p.73
8	Indicators	Shows the projector's status through a combination of indicators lit and flashing. p.73
9	Remote receiver	Receives signals from the remote control. p.23





When the Illumination function is set to **Off**, all indicators are off under normal projection conditions.

➡ **Extended - Operation - Illumination** p.65

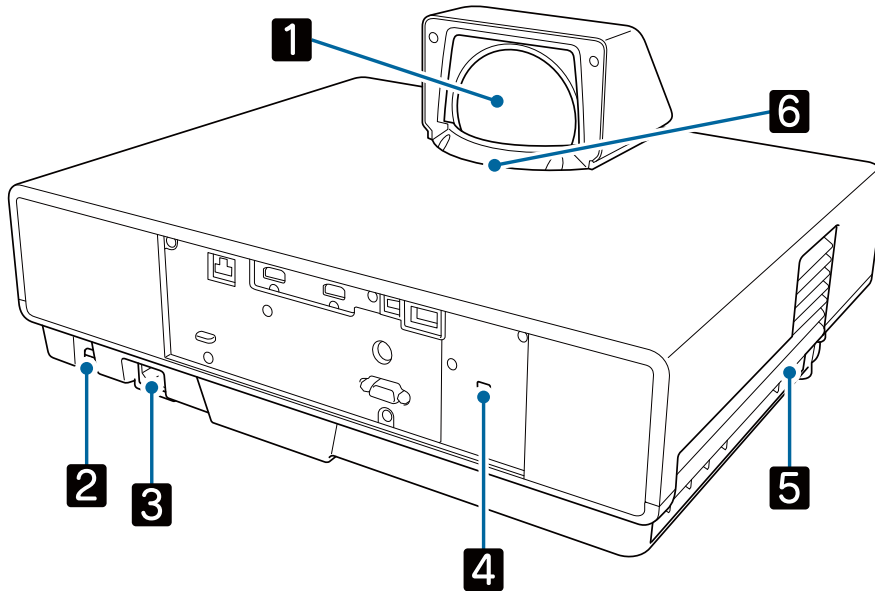
Rear/Top



Name		Function
1	Lens	Images are projected from here.
2	Security cable section	Secure a commercially available anti-theft wire lock through this section.
3	Power inlet	Connect the power cord.
4	Security slot ()	The security slot compatible with the MicroSaver security system manufactured by Kensington. For more details, visit the homepage of Kensington at http://www.kensington.com/ .
5	Air exhaust vent	Exhaust vent for air used to cool the projector internally. <div style="border: 1px solid black; padding: 5px;"> <p> Caution</p> <p>While projecting, do not put your face or hands near the air exhaust vent, and do not place objects that may become warped or damaged by heat near the vent. Hot air from the air exhaust vent could cause burns, warping, or accidents to occur.</p> </div>
6	Remote receiver	Receives signals from the remote control. ➡ p.23

Connector Ports

Rear

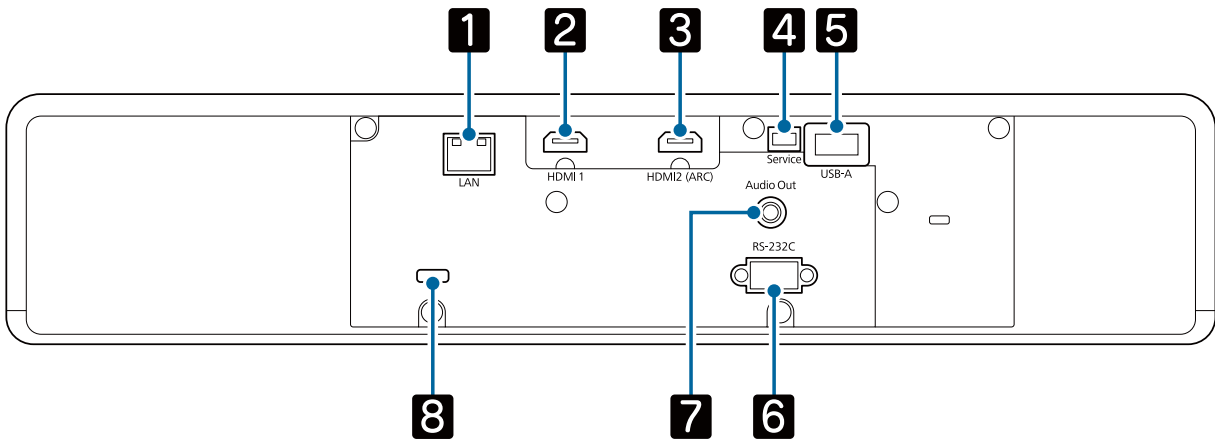

Front

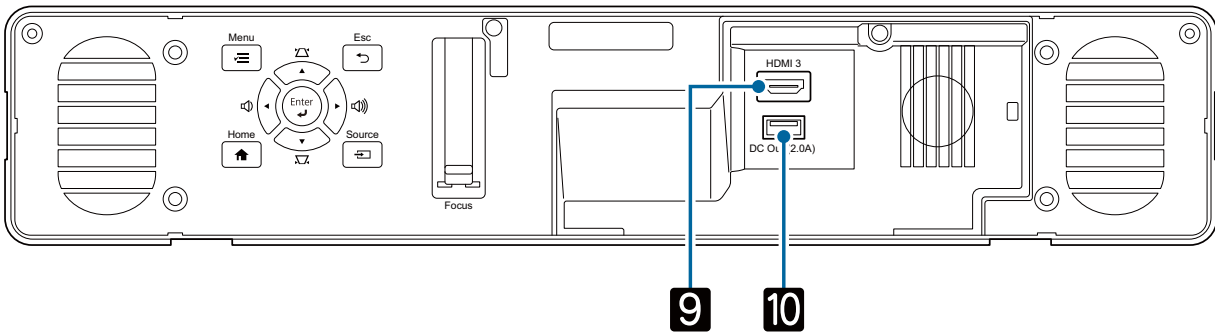

Name	Function
1 LAN port	Connects a LAN cable to connect to a network. p.20
2 HDMI1 port	Connects HDMI compatible video equipment and computers. p.20
3 HDMI2 (ARC) port	Connects HDMI compatible video equipment and computers. p.20 You can also output audio by connecting an ARC compatible AV amplifier. p.22
4 Service port	Service port. This is not normally used.
5 USB-A port	Connects the optional Wireless LAN unit. It is also used when updating the firmware. p.21
6 RS-232C port	When controlling the projector, connect the projector to a computer with an RS-232C cable. This port is for control use and should not normally be used. p.101
7 Audio Out port	Outputs audio during playback to external speakers. p.21
8 Cable holder	Pass a commercially available cable tie through here to secure the cables.
9 HDMI3 port	Inputs signals from a streaming media player. p.18
10 DC Out (2.0A) power supply port	Provides power to a streaming media player. p.18

Base

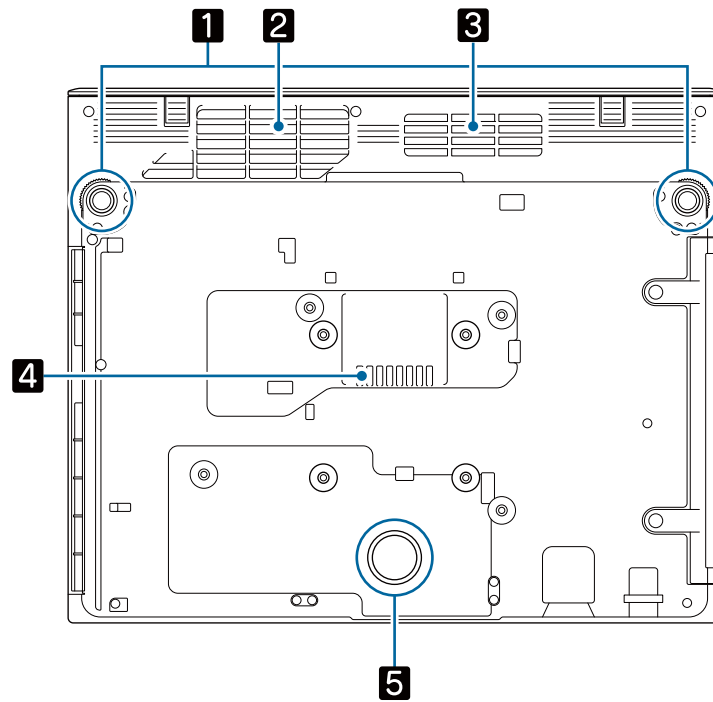

Name		Function
1	Front adjustable foot	When the projector is set up on a table, extend the foot to correct vertical distortion in the image. p.29
2	Air intake vent	Takes in air to cool the projector internally.
3	Air intake vent	Takes in air to cool the streaming media player.
4	Air exhaust vent	Air exhaust vent to cool the streaming media player.
5	Rear foot	Supports the projector when it is set up on a table.

Control Panel

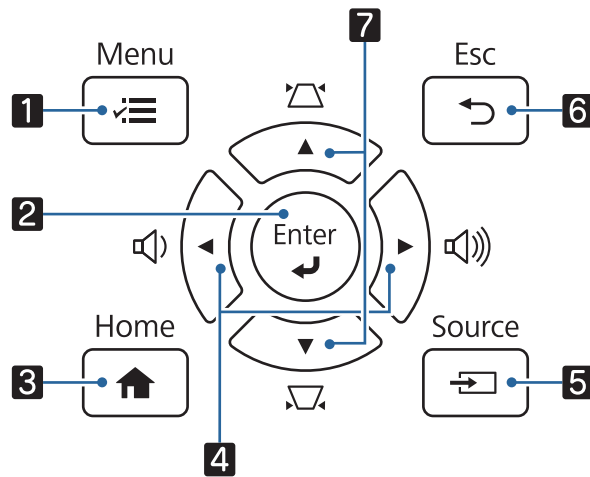

	Name	Function
1	[Menu] button	Displays and closes the Configuration menu. On the Configuration menu, you can make adjustments and settings for Signal, Image, and so on. p.59
2	[Enter] button	When a menu is displayed, it confirms the current item and moves to the next level. p.59
3	[Home] button	Displays or closes the Home screen. p.26
4	Volume (Left/Right) buttons	<ul style="list-style-type: none"> • Adjusts the volume. p.32 • Selects menu items or adjustment values while displaying the projector's menu. p.59 • When the Keystone screen is displayed, you can adjust horizontal distortion in the projected image. p.30
5	[Source] button	Changes to the image from each input port. p.25
6	[Esc] button	Returns to the previous menu level when a menu is displayed. p.59
7	Keystone (Up/Down) buttons	<ul style="list-style-type: none"> • Selects menu items or adjustment values while displaying the projector's menu. p.59 • Adjusts keystone distortion in projected images. p.30

Remote Control

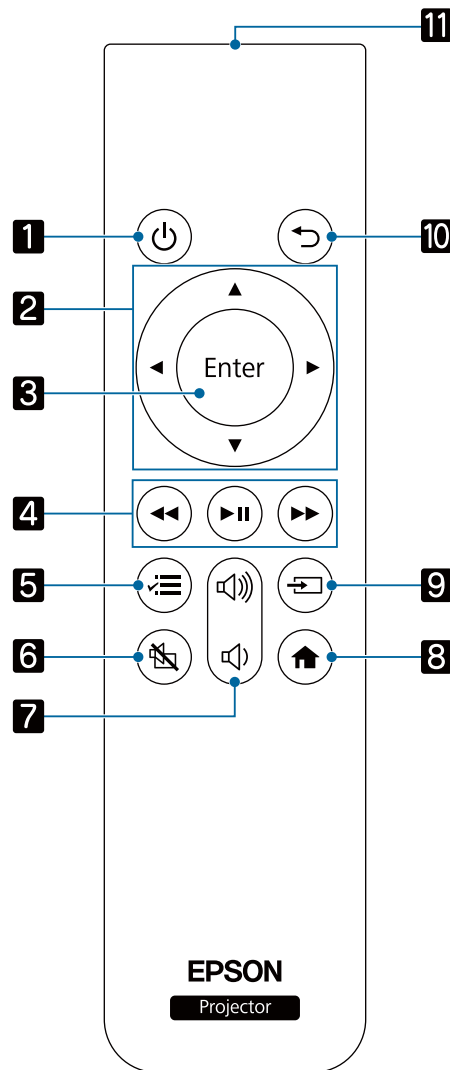

Name		Function
1	Standby button	Turns the projector on or off. p.24
2	Up/Down/Left/Right buttons	Selects menu items and adjustment values. p.59
3	[Enter] button	When a menu is displayed, it confirms the current item and moves to the next level. p.59
4	Playback control buttons	Operates a streaming media player and video devices compliant with the HDMI CEC standard. p.48
5	Menu button	Displays and closes the Configuration menu. On the Configuration menu, you can make adjustments and settings for Signal, Image, and so on. p.59
6	A/V Mute button	Temporarily hides or shows the image and audio. p.32
7	Volume buttons	Adjusts the volume. p.32
8	Home button	Displays or closes the Home screen. p.26
9	Source button	Changes to the image from each input port.
10	Esc button	Closes the current function. Press when a menu is displayed to return to the previous menu level. p.59

	Name	Function
11	Remote control light emitting area	Outputs remote control signals.



Installing

Projected Image and Position of Projector

Install the projector on a table in your living room or on a low shelf to project images.

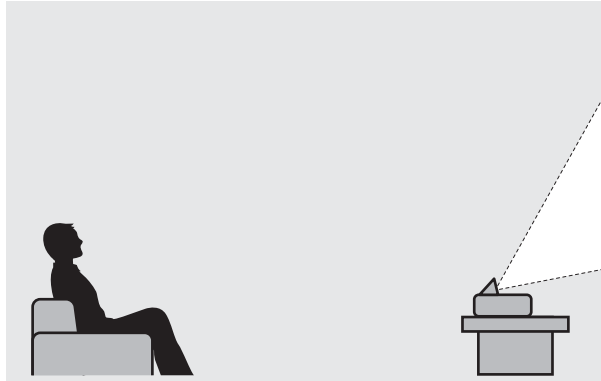

Follow the steps below to install the projector.

■ Installing in parallel with the screen

If the projector is installed at an angle to the screen, keystone distortion occurs in the projected image. Adjust the projector's position so that it is installed in parallel with the screen.

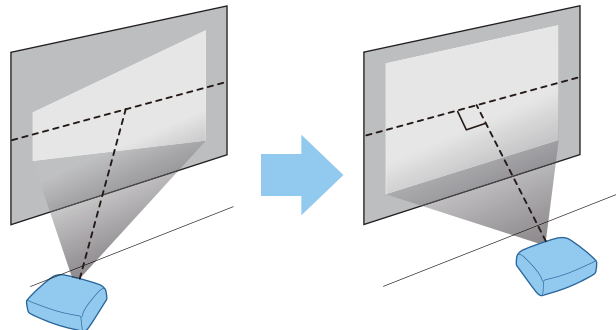

If the projector cannot be installed directly in front of the screen, adjust the position of the projected image.  [p.28](#)

■ Installing the projector horizontally by adjusting the height of either side

If the projector is tilted, the projected image is also tilted.

Install the projector horizontally so that both sides are at the same height.

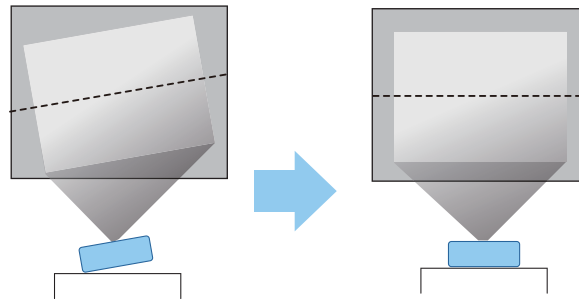

Warning

- Do not set up the projector in locations exposed to humidity or dust, or in locations exposed to oil smoke or steam such as on a kitchen counter, in the kitchen, or near a humidifier. Doing so could cause fire or electric shock.
- Do not install in locations where salt damage could occur, or in locations subject to corrosive gas such as sulphuric gas from hot springs. Otherwise, corrosion could cause the projector to fall. It could also cause the projector to malfunction.
- Do not install it on an unstable shelf or in a place out of load range. Otherwise, it could fall or topple causing an accident and injury.
- When installing the projector in a high position such as on a shelf, take measures against falling by using wires or belts to ensure safety in an emergency such as an earthquake, and to prevent accidents. If it is not installed correctly, it could fall causing an accident and injury.
- Do not block the air intake vent and air exhaust vent of the projector. Blocking its air intake vent and air exhaust vent may trap heat inside causing fire.
- Do not place a cloth or any paper under the projector. The cloth or paper could be sucked up by the Air intake vent on the bottom of the projector during projection causing the internal temperature to rise which could start a fire.

Attention

- Do not use the projector installed vertically. Doing so could cause a malfunction.
- We recommend cleaning the air filter every 20,000 hours. Clean it more often if the environment is particularly dusty.  [p.86](#)

■ Precautions on Installation

Be sure to leave the following amount of space around the projector so as not to block the air exhaust and intake vents.

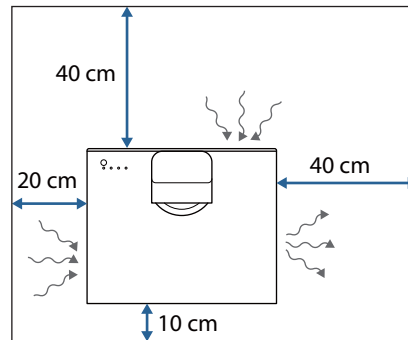

Screen Size and Projection Distance

Use the table below to setup the projector at the optimum position from the screen. The values given here are for your reference only.

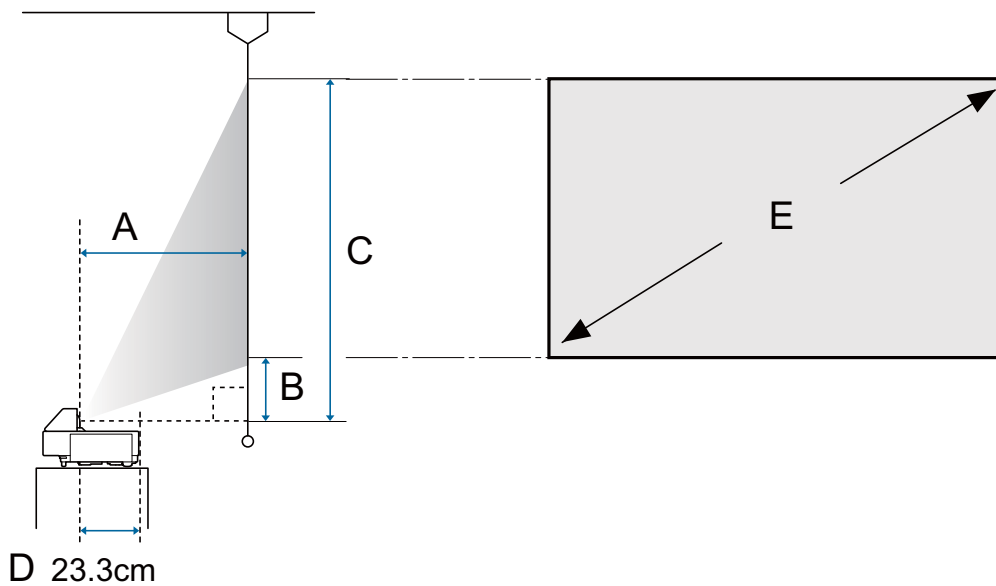

- A : Projection distance
- B : Distance from the projector to the bottom of the screen
- C : Distance from the projector to the top of the screen
- D : Distance from the center of the lens to the back of the projector
- E : Size of the projected image

Unit: cm

16:9 Screen Size		A	B	C
E	W x H	Minimum (Wide) to Maximum (Tele)	Minimum (Wide)	Minimum (Wide)
70"	155 x 87	43 - 59	12	99
80"	177 x 100	49 - 67	14	114
90"	199 x 112	56 - 76	16	128
100"	221 x 125	62*	17	142
110"	244 x 137	69*	19	156
120"	266 x 149	75*	21	170
130"	288 x 162	82*	23	185

* Projecting using Wide (maximum zoom)

Connecting a Device

Attention

- Make cable connections before connecting to a power outlet.
- Check the shape of the cable's connector and the shape of the port, and then connect. If you force a connector of a different shape into the port, it could cause damage and a malfunction to occur.

Connecting a Streaming Media Player

To project images from a streaming media player, connect them using the HDMI extension cable and the USB power cable supplied.

Prepare a commercially available streaming media player.

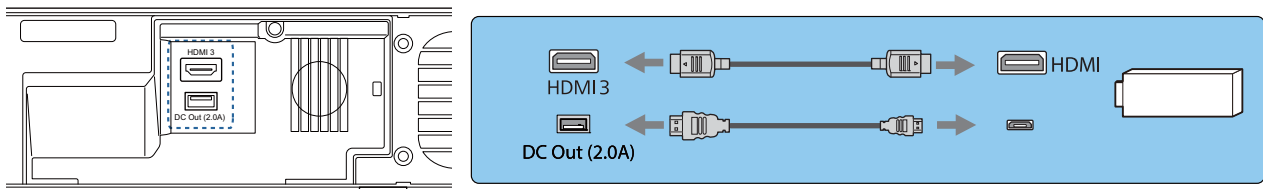

1 Remove the front cover.

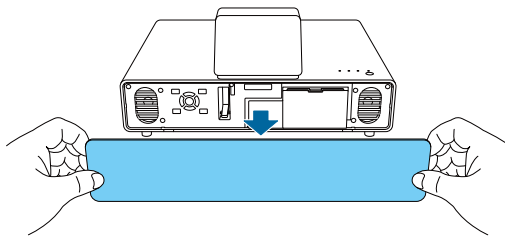

2 Remove the storage space cover.

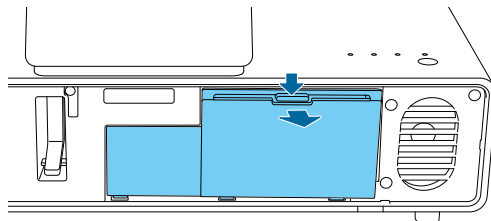

3 Connect the HDMI extension cable supplied to the HDMI3 port.

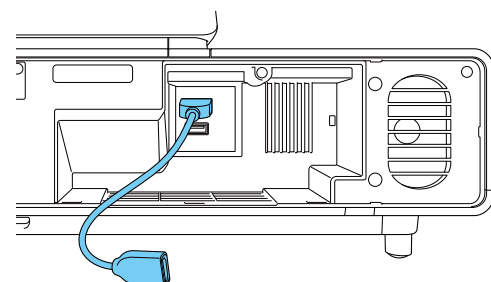

4 Connect the USB power cable supplied to the DC Out (2.0A) power supply port.

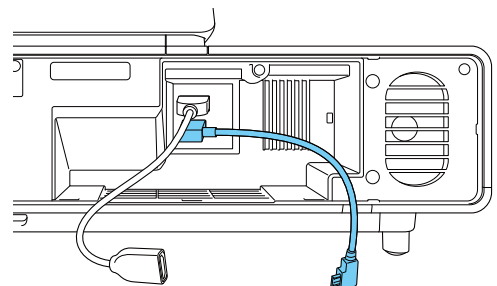

5 Connect the streaming media player to the HDMI extension cable.

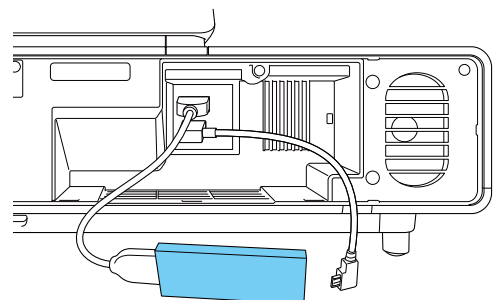

6

Connect the USB power cable to the USB port (type B) on the streaming media player.

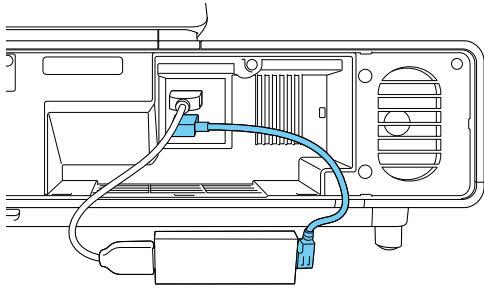

7

Place the streaming media player in the storage space.

Arrange the cables as shown in the following diagram.

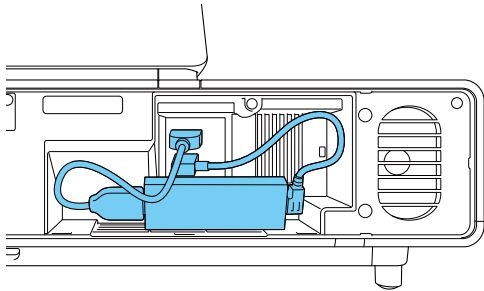

8

Replace the storage space cover.

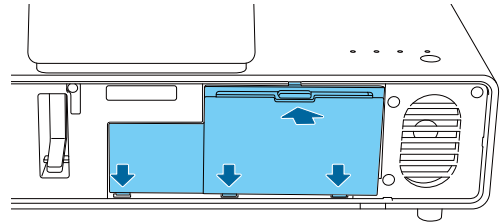

Attention

Make sure the cables are not caught by the cover. You cannot close the cover if it catches on the cables.

9

Replace the front cover.

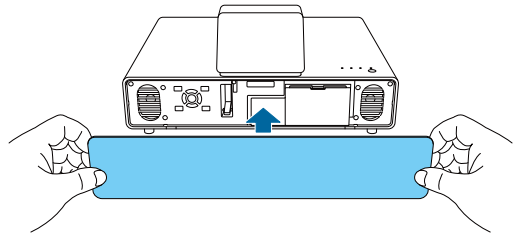

Connecting Video Equipment

To project images from DVD/Blu-ray players, connect to the projector using an HDMI cable (commercially available).

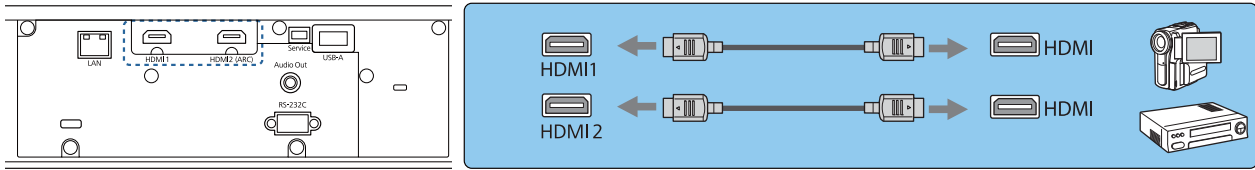

- To display signals in the 18 Gbps transmission band, such as 4k60p/4:4:4, use a premium HDMI cable. If you use a cable that does not support it, images may not be displayed properly. If you experience any trouble displaying images at 18 Gbps, change the EDID setting to **Normal**. **Signal - Advanced - EDID p.62**
- You can also connect your AV system to enjoy the audio from connected equipment.

Connecting a Computer

To project images from a computer, connect to the projector using an HDMI cable (commercially available).

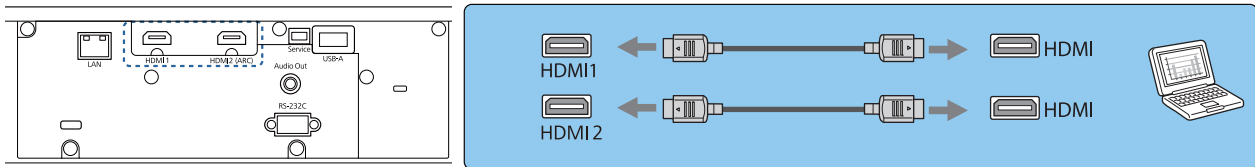

Connecting to the LAN Port

Connect to a network router, a hub, and so on, with a 100BASE-TX or 10BASE-T LAN cable. You can operate the projector or check its status over a network from a computer or a smart device.

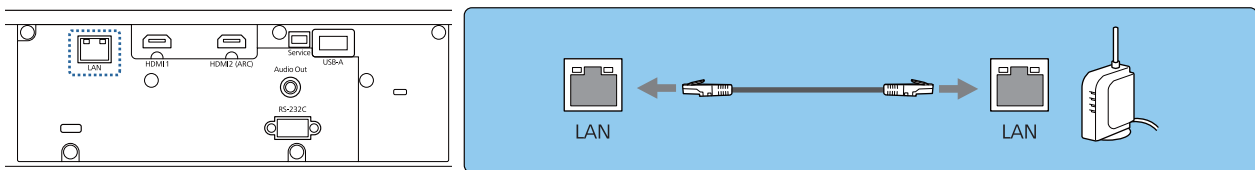

To prevent malfunctions, use a category 5 or higher shielded LAN cable.

Attaching the Wireless LAN Unit

When using the wireless LAN function, connect the optional Wireless LAN unit (ELPAP10) to the USB-A port.

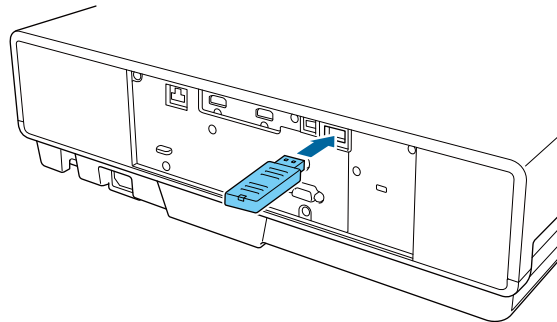

You can use one of the following methods to project over wireless LAN. For more details, see the download page.

- **Projecting four screens simultaneously**

When using Epson iProjection (Windows/Mac), you can display up to four separate screens from the projector from up to 50 computers connected to the network.

You can download Epson iProjection (Windows/Mac) from the following Web site.

<https://www.epson.com>

- **Projecting images from a mobile terminal via a network**

By installing Epson iProjection (iOS/Android) on a smartphone or tablet, you can wirelessly project data on your device. 🖱️ p.56



- When not using the wireless LAN function with the Wireless LAN unit kept inserted, set **Wireless LAN Power to Off**. This can prevent unauthorized access from outsiders. 🖱️ p.68
- When using Epson iProjection in **Quick** connection mode, we recommend making security settings. 🖱️ p.70

Connecting External Speakers

To output audio from external speakers, connect the speakers to the projector's Audio Out port with a commercially available audio cable.

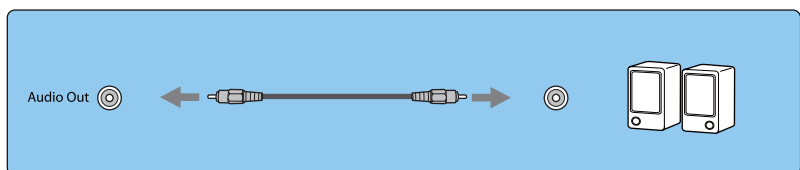
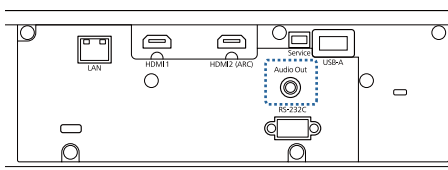



- To output audio from external speakers, set **Audio Out Device to Projector**. 🖱️ **Settings - HDMI Link - Audio Out Device** p.63
- When an AV system is not connected to the projector, audio is output from the external speakers, even if **Audio Out Device** is set to **AV System**.

Connecting an ARC Compatible AV System

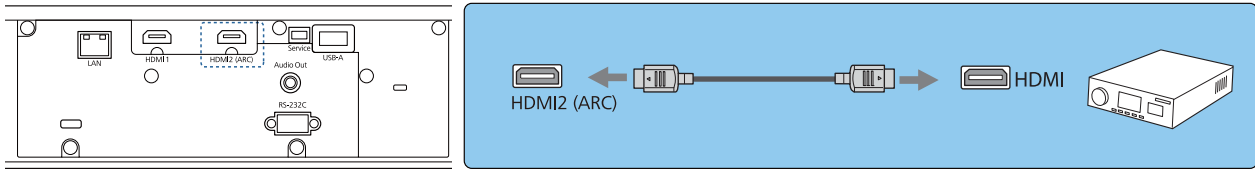
To output audio from an ARC compatible AV System, use an HDMI cable (commercially available) to connect the AV System to the HDMI2 (ARC) port on the projector.



Make the following settings when outputting audio from an ARC compatible AV System.

- Set the **Audio Out Device** to **AV System**.  **Settings - HDMI Link - Audio Out Device** [p.63](#)
- When the AV System is connected to the projector, set **HDMI Link** to **On**.  **Settings - HDMI Link** [p.63](#)

Preparing the Remote Control

Installing the Remote Control Batteries

Attention

- Check the positions of the (+) and (-) marks inside the battery holder to ensure the batteries are inserted the correct way.
- You cannot use other batteries except for AAA size manganese or alkaline.

- 1** Remove the battery cover.
While pushing the battery compartment cover catch, lift the cover up.

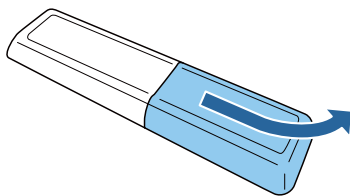

- 2** Replace the old batteries with new batteries.
Check the polarity of the batteries (+) and (-) before installing.

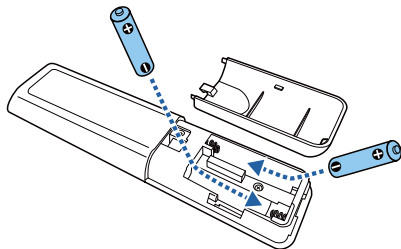

- 3** Reattach the battery cover.
Press the cover until it clicks into place.

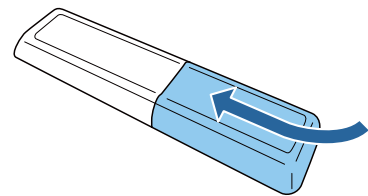

 If delays in the responsiveness of the remote control occur or if it does not operate, it probably means that the batteries are becoming flat. Replace with two new batteries (AAA size manganese or alkaline batteries).

Remote Control Operating Range

Operating range (left to right)

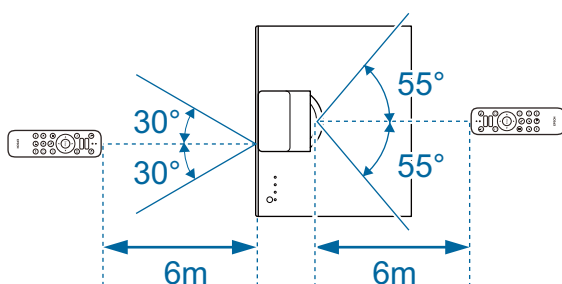

Operating range (top to bottom)

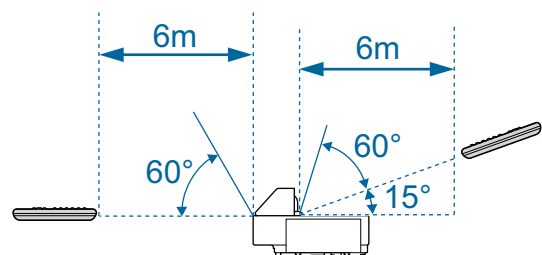

Projecting Images

Turning On the Projector

1 Connect the equipment to the projector.

2 Connect using the power cord supplied.

3 Remove the lens cap.

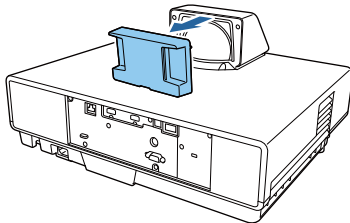

Attention

If the projector is turned on while the lens cap is attached, the lens cap becomes hot due to the light from the projector. Make sure you remove the cap before turning on the projector.

4 Press the standby button on the remote control or on top of the projector to turn it on.

Remote control

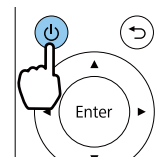

Top of projector



The projector's status indicator flashes blue as the projector warms up. Once the projector is warmed up, the standby indicator and the status indicator turn blue.



- When **Direct Power On** is set to **On**, you can start projecting by simply connecting the power cord to the projector without having to press any buttons.
 - ☛ **Extended - Operation - Direct Power On** p.65
- If you turn on **Quick Startup** from the **Extended** menu, the projector will be ready to project in a just a few seconds the next time it is turned on.
 - ☛ **Extended - Operation - Quick Startup** p.65

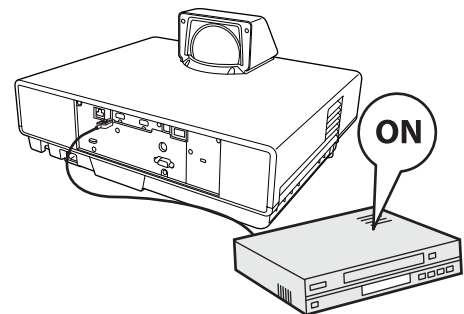

5 Turn on the connected equipment.



 **Warning**

- Do not look into the lens during projection. The powerful light emitted could cause damage to eyesight. Pay close attention to how your child behaves.
- When using the remote control to turn it on while you are away from the projector, make sure no one is looking into the lens.
- Do not stand in front of the lens during projection. Clothes could be damaged due to the high temperature.



- This projector provides a Child Lock function to prevent children from accidentally turning the power on and a Control Panel Lock function to prevent accidental operations and so on.  **Settings - Lock Setting - Child Lock/Control Panel Lock** [p.63](#)
- When using at an altitude of 1500 m or more, set **High Altitude Mode** to **On**.  **Extended - Operation - High Altitude Mode** [p.65](#)

 **If the target image is not projected**

If the image is not projected, you can change the source using one of the following methods.

Remote control

Press the source button and select the target port.

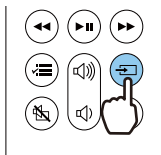

Control panel

Press the [Source] button and select the target port.

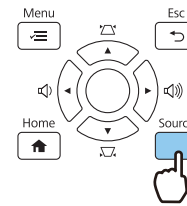

- If you press the [Home] button on the control panel, you can also make settings from the Home screen.  [p.26](#)
- You can also display the Home screen by using the home button on the remote control.

Using the Home Screen

The Home screen feature allows you to easily select an image source and access useful functions.





Press the [Home] button on the control panel to display the Home screen.

You can also display the Home screen by using the home button on the remote control.

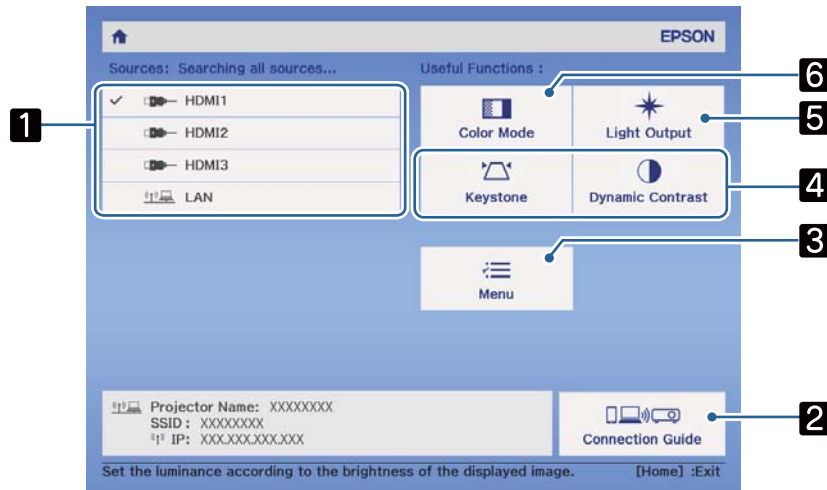
Under the following conditions, the Home screen is displayed automatically when the projector is turned on.

- **Home Screen Auto Disp.** is set to **On**.  **Extended - Home Screen - Home Screen Auto Disp.** [p.65](#)
- There are no signals from any sources.



1	Selects the source you want to project.
2	Displays the Connection Guide.
3	Displays the Configuration menu.  p.59
4	Performs menu options assigned to Custom Function 1 and Custom Function 2 on the Home Screen .  Extended - Home Screen p.65
5	Sets the brightness for the light source.  Image - Light Output p.60
6	Selects the Color Mode .  p.33  Image - Color Mode p.60



The Home screen disappears after 10 minutes of inactivity.

Turning Off

1 Turn off the connected equipment.

2 Press the standby button on the remote control or on top of the projector.

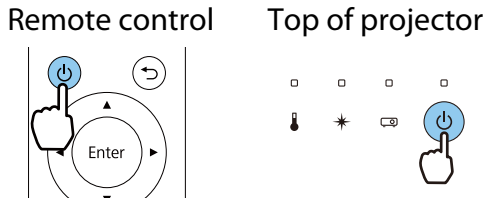

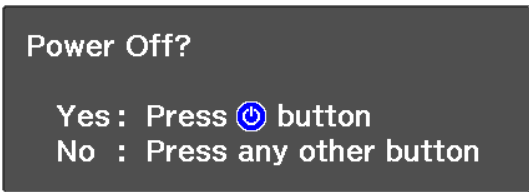

A confirmation message is displayed.

3 Press the standby button again.



The status indicator flashes and the projector begins to cool down.

 When **Standby Confirmation** is set to **Off**, you can turn off the projector by pressing the button on the remote control once.  **Extended - Display - Standby Confirmation** [p.65](#)

4 Wait until cool-down is complete.

When cool-down is complete, the status indicator stops flashing.



5 Disconnect the power cord.

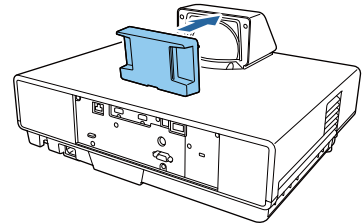

- If the power cord is connected, some electricity is consumed even if no operations are made.
- When connecting the power cord again, wait a sufficient time interval.

6 Attach the lens cap.



 When **USB Power in Standby** is set to **On**, power is supplied to the streaming media player even when the projector is in standby mode (power off); this helps to speed up turning on the streaming media player.  **Extended - Operation - USB Power in Standby** [p.65](#)



Adjusting the Projected Image



Since images are unstable immediately after the projector is turned on, before you make focus, zoom, or lens shift settings, we recommend waiting 20 minutes or more after starting to project the images.

Adjusting the Focus

Adjust the focus by moving the focus lever up or down.

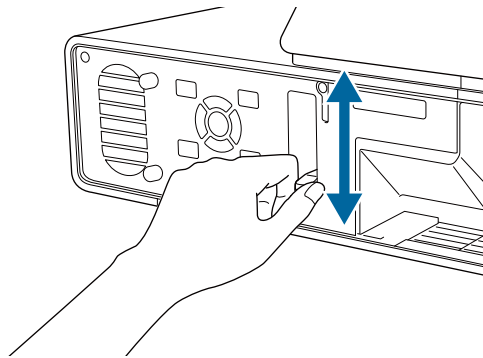
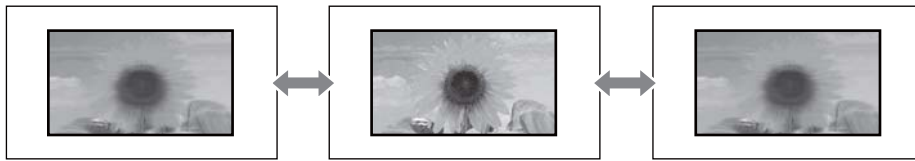

Adjusting the Projection Size (Adjust Zoom)

The zoom function adjusts the size of the projected image.

- 1 Press the [Menu] button to display menus in the order **Settings - Zoom**.

Remote control

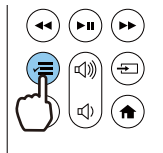

Control panel

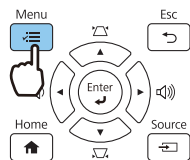

- 2 Use the left and right buttons to make adjustments.

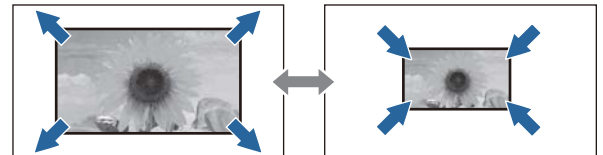

- 3 Press the [Menu] button to exit the menu.

Adjusting the Position of the Image (Image Shift)

You can adjust the position of the projected image without having to move the projector. 🖱️ **Settings - Image Shift** p.63

1 Press the [Menu] button to display menus in the order **Settings - Image Shift**.

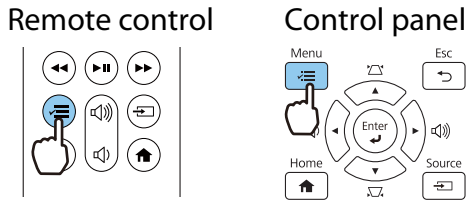

2 Press the up/down/left/right buttons to adjust the position of the image.

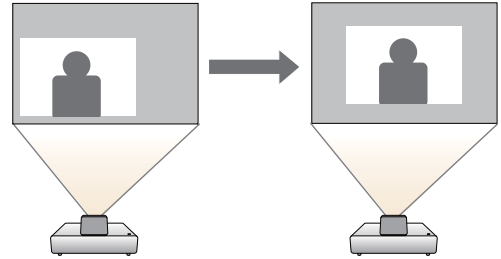

3 Press the [Menu] button to exit the menu.

- 📖 • Use zoom to adjust the size of the image, and then adjust the projection position by using Image Shift. You cannot adjust the projection position when the zoom is set to maximum wide.
- Images are not stable immediately after the projector is turned on. Wait for at least 20 minutes after you start projecting to adjust the projection position.
- The setting for Image Shift is stored even when the projector is turned off. If you change the projector's installation position or angle, make adjustments again.

Correcting Vertical Distortion in the Image

If the projected image is distorted vertically, adjust the front foot so that the image and the screen are at the same angle.

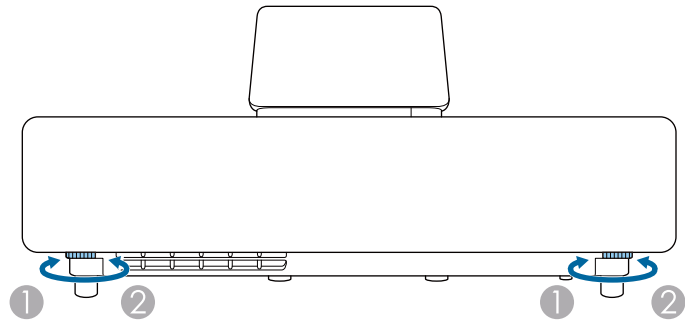
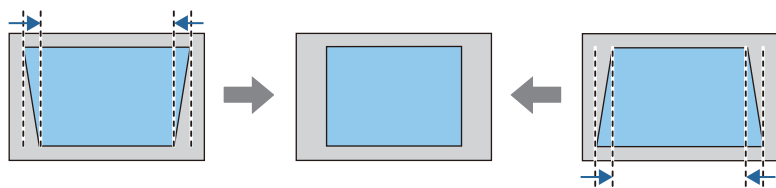



- ① Retract the foot
- ② Extend the foot

Correcting Keystone Distortion

If you place the projector at an angle to the screen, or tilt it up or down, or off to the side, you may need to correct the distortion in the image.

You can correct it by using one of the following two methods.

- Correct the vertical and horizontal distortion  [p.30](#)
- Correct the corners of the projected image individually  [p.31](#)

Correct using the Keystone buttons

You can use the up/down/left/right buttons on the control panel or the remote control to correct vertical and horizontal keystone distortion.

Press the up or down button on the control panel to display the V-Keystone/H-Keystone gauges.

When the gauges are displayed, press the up and down buttons to perform vertical correction, and press the left and right buttons to perform horizontal correction.



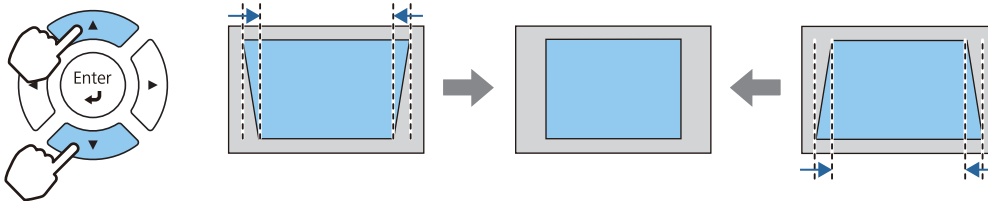

When the top or bottom is too wide

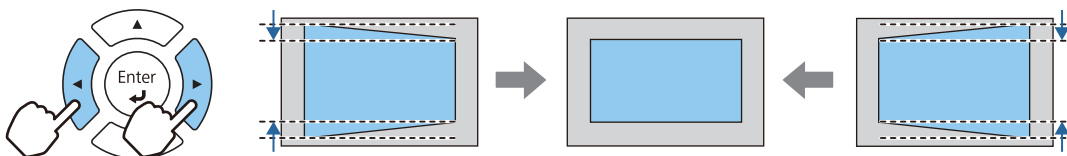

When the left or right is too wide



- When you correct keystone distortion, the projected image may be reduced. Increase the projection distance to fit the projected image to the screen size.
- You can also set H/V-Keystone from the Configuration menu.  **Settings - Keystone - H/V-Keystone** [p.63](#)
- You can make effective corrections within a projection angle of 3° up, down, left, and right.
- You can adjust the volume by pressing the left/right buttons on the control panel when the V-Keystone/H-Keystone gauges are not displayed.  [p.32](#)

■ Correcting with Quick Corner

You can use the projector's Quick Corner setting to correct the shape and size of an image that is unevenly rectangular.

- 1 Press the [Menu] button to display menus in the order **Settings - Keystone**.

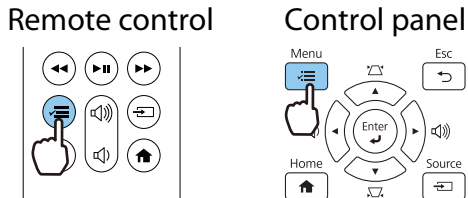

- 2 Use the up and down buttons to select **Quick Corner**, and then press the [Enter] button. Press the [Enter] button again if necessary.

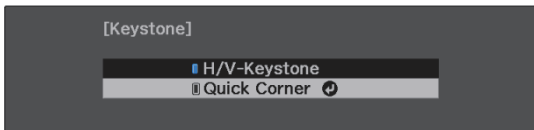

The area selection screen is displayed.

- 3 Use the up/down/left/right buttons to select the corner of the image you want to adjust. Then press the [Enter] button.

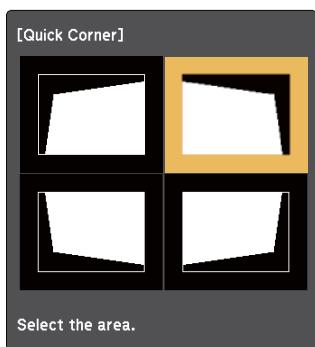

📖 To reset the Quick Corner corrections, hold down the [Esc] button for about two seconds while the area selection screen is displayed, and then select **Yes**.

- 4 Press the up/down/left/right buttons to adjust the shape of the image as necessary. Press the [Enter] button to return to the area selection screen.

📖 If you see this screen, you cannot adjust the shape any further in the direction indicated by the gray triangle.

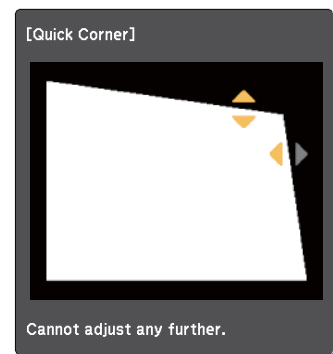

- 5 Repeat steps 3 and 4 as needed to adjust any remaining corners.

- 6 When you are finished, press the [Esc] button.

📖 After executing Quick Corner, the **Keystone** setting is now set to **Quick Corner** in the projector's **Settings** menu. When you press the up or down button on the control panel, the area selection screen is displayed.

Adjusting the Volume

You can adjust the volume by using the volume buttons on the remote control or on the control panel.

Remote control

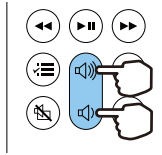

Control panel

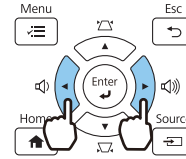

- You can also adjust the volume from the Configuration menu. 🖱️ **Settings - Volume** p.63
- When an AV System is connected to the projector and you want to adjust the volume for the AV system, set **HDMI Link** to **On** and **Audio Out Device** to **AV System**. 🖱️ **Settings - HDMI Link** p.63



Caution

Do not start at high volume.

A sudden excessive volume may cause loss of hearing. Always lower the volume before powering off, so that you can power on and then gradually increase the volume.

Hiding the Image and Muting the Audio Temporarily (A/V Mute)

Press the A/V mute button on the remote control to show or hide the image. The audio is also muted or played.

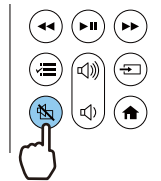

- For movies, the image and audio continue to play even during A/V Mute. You cannot resume projection from the point that you muted the video and audio using the A/V mute button.
- When outputting audio from an AV system and you want to adjust the volume for the AV system, set **HDMI Link** to **On** and **Audio Out Device** to **AV System**. 🖱️ **Settings - HDMI Link** p.63

Adjusting the Image

Selecting the Projection Quality (Color Mode)

You can obtain the optimum image quality to suit your surroundings when projecting. The brightness of the image varies depending on the mode selected.

- 1 Press the [Menu] button to display menus in the order **Image - Color Mode**.

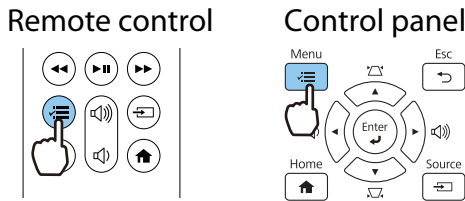

 If you press the [Home] button on the control panel or the home button on the remote control, you can also make settings from the Home screen. [p.26](#)

- 2 Use the up and down buttons to select a mode, and then press the [Enter] button to confirm the selection.



Mode	Application
Dynamic	This is the brightest mode. Best for prioritizing brightness.
Bright Cinema	Best for projecting vivid images.
Cinema	Best for enjoying content such as movies.
Game	Best for enjoying content such as video games.

Switching the Screen Between Full and Zoom (Aspect)

You can change the input signal's type, aspect ratio, and resolution to match the **Aspect** of the projected image.

The available settings vary depending on the image signal currently being projected.

 Note that using the aspect ratio function of the projector to reduce, enlarge, or split the projected image for commercial purposes or for public viewing may infringe upon the rights of the copyright holder of that image based on copyright law.

1 Press the [Menu] button to display menus in the order **Signal - Aspect**.

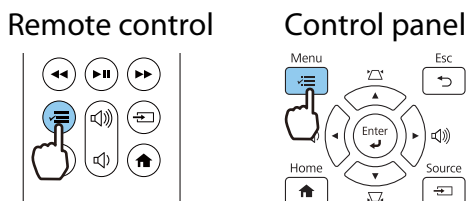



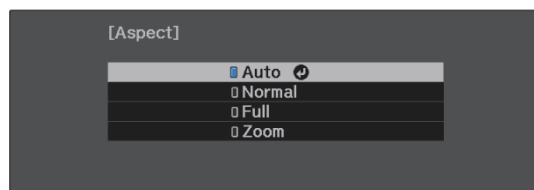





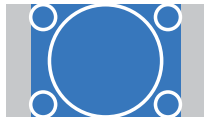

2 Use the up and down buttons to select the aspect mode, and then press the [Enter] button to confirm the selection.



 You cannot switch the **Aspect** when the Source is LAN. Also, when the Source is HDMI1/HDMI2/HDMI3, you may not be able to change the **Aspect** depending on the input signal.

By normally selecting **Auto**, the optimum aspect is used to display the input signal. Change the setting if you want to use a different aspect.

Aspect Mode	Aspect Ratio for Input Signal		
	16:10	16:9	4:3
Normal			
Full			
Zoom			

 When a 4K image signal is being input, you can only select **Normal**.

Adjusting the Sharpness

You can make the image clearer.

The following shows the setting items and procedures.

Standard	Enhances the outlines for the projected image overall. When you adjust Standard , the adjustment values for Thin Line Enhancement and Thick Line Enhancement are also adjusted.
Thin Line Enhancement	Details such as hair and patterns on clothing are enhanced.
Thick Line Enhancement	Rough parts such as outlines for entire subjects or the background are enhanced, making the overall image clearer.

- 1 Press the [Menu] button to display menus in the order **Image - Sharpness**.

Remote control

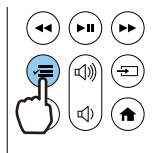

Control panel

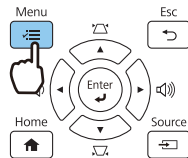

The **Sharpness** adjustment screen is displayed.

- 2 Use the up and down buttons to select the item, and then use the left and right buttons to make the adjustments.

The image is enhanced when moved to the right (positive) and softer when moved to the left (negative).

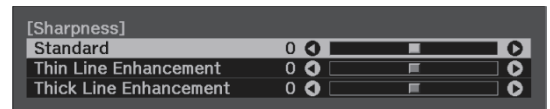

- 3 Press the [Menu] button to exit the menu.

Adjusting Image Resolution (Image Enhancement)

You can adjust the resolution of the image using the Image Enhancement function.

The following content can be adjusted.

4K Enhancement*3	4K Enhancement is a function that projects an image at a doubled resolution by diagonally shifting 1 pixel in increments of 0.5 pixels. A high-resolution image signal is projected in fine detail.
Image Preset Mode	Select the settings prepared in advance as the settings for Noise Reduction , MPEG Noise Reduction , Super-resolution , and Detail Enhancement .
Frame Interpolation*1 *2 *3	Plays movies smoothly.  p.37
Deinterlacing*1 *2	Converts the signal from interlaced to progressive using a method appropriate for the image signal.
Noise Reduction*1 *2 *3 *4	Smooths out rough images.
MPEG Noise Reduction*1 *2 *3 *4	You can reduce dot and block noise that occurs in outlines when projecting MPEG movies.
Super-resolution*2	Fine Line Adjust: Enhances the contrast and the outlines of complicated images. Soft Focus Detail: Enhances the contrast and the outlines for smooth backgrounds.
Detail Enhancement*2	Enhances the contrast in an image to create a more emphatic texture and material feel. Strength: The larger the value, the stronger the contrast. Range: The larger the value, the wider the range of detail enhancement becomes.

*1 This can only be set when **Signal - Advanced- Image Processing** is set to **Fine**.

*2 This can be set at any time except when **Image Preset Mode** is set to **Off**.

*3 This cannot be set when 4K signals are being input.

*4 This cannot be set when 21:9 signals are being input.

- 1 Press the [Menu] button to display menus in the order **Image - Image Enhancement**.

Remote control

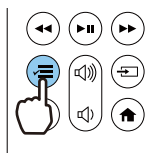

Control panel

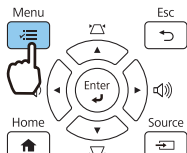

- 2 Use the up and down buttons to select the item you want to adjust, and then press the [Enter] button to confirm the selection.

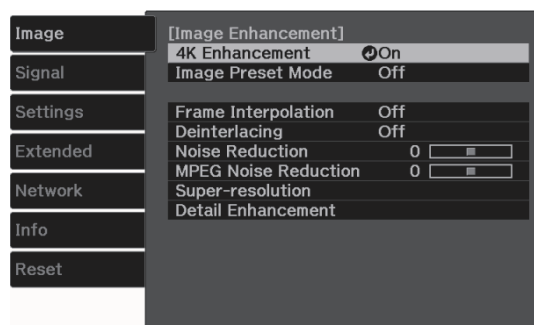

- Use the left and right buttons to make adjustments.

Press the [Esc] button to adjust another item.



- Press the [Menu] button to exit the menu.

Adjusting the Luminance for Images

When **Dynamic Contrast** is set to **On**, the luminance of the projected image is adjusted automatically. Automatically adjusting the luminance improves the contrast according to the brightness of the image.

- Press the [Menu] button to display menus in the order **Image - Dynamic Contrast**.

Remote control

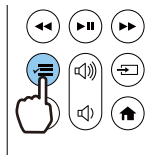

Control panel

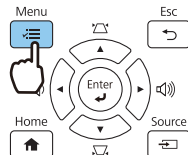

- Use the up and down buttons to select the item, and then press the [Enter] button to confirm the selection.

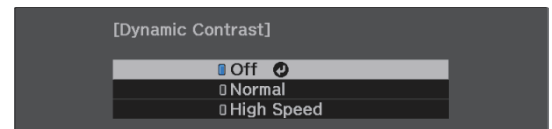

Setting Frame Interpolation

You can play fast moving images smoothly by automatically producing intermediate frames between the original frames.

Frame Interpolation is available under the following conditions.

- When **Image Processing** is set to **Fine**. [Signal - Advanced - Image Processing p.62](#)
- When the source is HDMI1/HDMI2/HDMI3.
- When inputting 2D signals* or 3D signals (1080p 24 Hz). [p.96](#)

* This is unavailable when a 4K signal is being input. This is enabled only when **4K Enhancement** is set to **On** and 1080p 24 Hz signals are being input. [Image - Image Enhancement - 4K Enhancement p.60](#)

- Press the [Menu] button to display menus in the order **Image - Image Enhancement - Frame Interpolation**.

Remote control

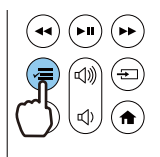

Control panel

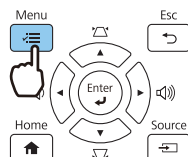

- Use the up and down buttons to select the item, and then press the [Enter] button to confirm the selection.

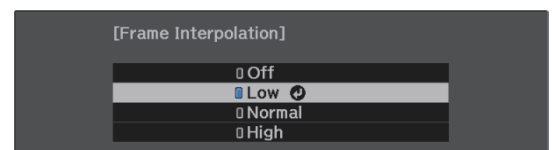

Setting the Image Processing Speed

Improves the response speed for images projected at high-speed, such as games.

This is only available when receiving a progressive signal input from the HDMI1/HDMI2/HDMI3 ports.

- 1 Press the [Menu] button to display menus in the order **Signal - Advanced - Image Processing**.

Remote control

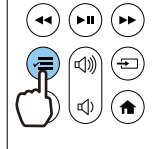

Control panel

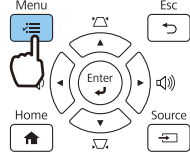

- 2 Use the up/down buttons to switch between **Fine** and **Fast**.



- This does not support 3D images.
- When **Image Processing** is set to **Fast**, **Noise Reduction**, **Frame Interpolation**, **Deinterlacing**, and **MPEG Noise Reduction** are fixed at Off.

Adjusting the Color

Adjusting the Color Temp.

Adjusts the tint for the images. Make adjustments if the image is a little too blue or too red and so on.

- 1 Press the [Menu] button to display menus in the order **Image - White Balance - Color Temp.**

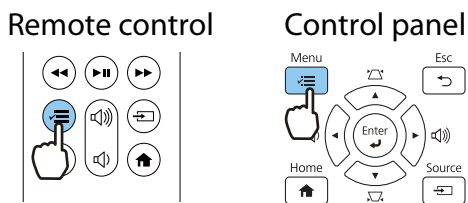

- 2 Use the left and right buttons to make adjustments.

Blue tints grow stronger as the value is increased, and red tints grow stronger as the value is reduced.



Adjusting the RGB (Offset and Gain)

You can adjust the brightness of dark areas (Offset) and bright areas (Gain) for R (red), G (green), and B (blue).

- 1 Press the [Menu] button to display menus in the order **Image - White Balance - Custom.**

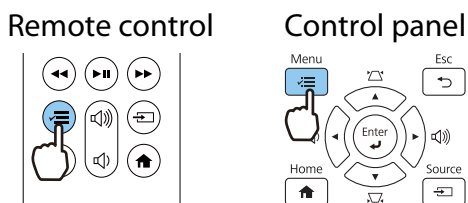

- 2 Use the up and down buttons to select the item, and then use the left and right buttons to make the adjustments.

The image becomes brighter when moved to the right (positive) and darker when moved to the left (negative).

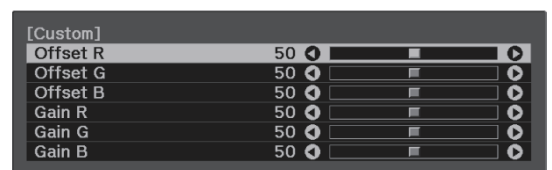

Offset	When the image is made brighter, shading for the darker sections is more vividly expressed. When the image is made darker, the image appears more full-bodied but shading for the darker sections is harder to distinguish.
Gain	When the image is made brighter, the bright sections become whiter and shading is lost. When the image is made darker, shading for the bright sections is more vividly expressed.

Adjusting Hue, Saturation, and Brightness

You can adjust the hue, saturation, and brightness for each of the R (red), G (green), B (blue), C (cyan), M (magenta), and Y (yellow) colors.

Hue	Adjusts the overall color of the image to be blue, green, or red.
Saturation	Adjusts the overall vividness of the image.
Brightness	Adjusts the overall color brightness of the image.

- 1 Press the [Menu] button to display menus in the order **Image - Advanced - RGBCMY**.

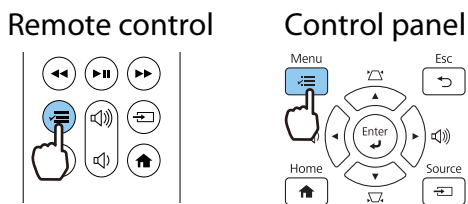

- 2 Use the up and down buttons to select the color you want to adjust, and then press the [Enter] button to confirm the selection.

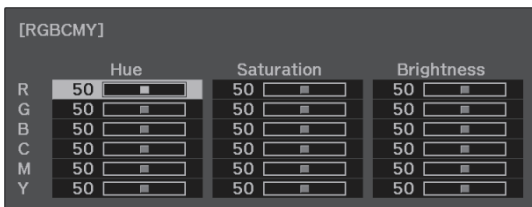

- 3 Use the up and down buttons to select **Hue, Saturation, or Brightness**.

- 4 Use the left and right buttons to make adjustments.

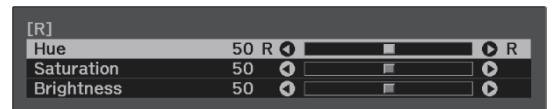

Press the [Esc] button to adjust another color.

- 5 Press the [Menu] button to exit the menu.

Adjusting the Gamma

You can adjust slight coloration differences that may occur due to the device being used when the image is displayed.

You can set it by using one of the following methods.

- Select and adjust the correction value
- Adjust using the gamma adjustment graph

■ Select and adjust the correction value

- 1 Press the [Menu] button to display menus in the order **Image - Advanced - Gamma**.

Remote control

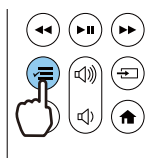

Control panel

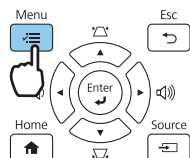

- 2 Use the up and down buttons to select the correction value, and then press the [Enter] button to confirm the selection.

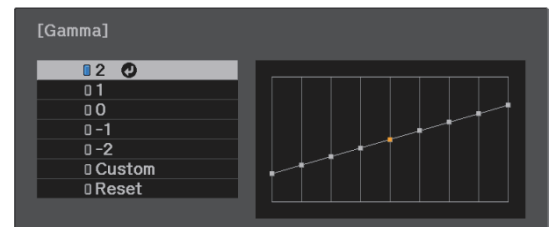

The larger the value, the lighter the dark portions of the image become, but bright areas may appear discolored. The upper part of the gamma adjustment graph becomes rounded.
The smaller the value, the darker the bright portions of the image become. The lower part of the gamma adjustment graph becomes rounded.



- The horizontal axis of the gamma adjustment graph shows the input signal level, and the vertical axis shows the output signal level.
- Select **Reset** to return the adjustments to their default values.

Adjust using the gamma adjustment graph

Select a tone point on the graph and make adjustments.

- 1 Press the [Menu] button to display menus in the order **Image - Advanced - Gamma - Custom**.

Remote control

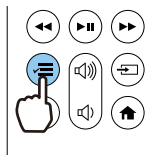

Control panel

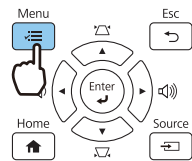

- 2 Use the left and right buttons to select the tone you want to adjust from the graph.

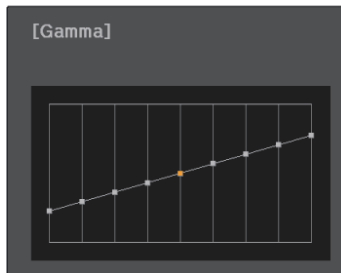

- 3 Use the up and down buttons to adjust the brightness, and then press the [Enter] button to confirm the selection.

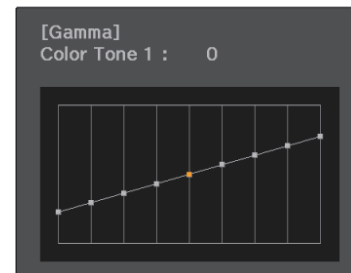

Viewing the Image at the Saved Image Quality (Memory Function)

Saving a Memory

By using the memory function, you can register settings for **Image** from the Configuration menu, and then load them when necessary.

1 Make the settings or adjustments you want to register.

2 Press the [Menu] button to display menus in the order **Settings - Memory**.

Remote control

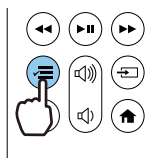

Control panel

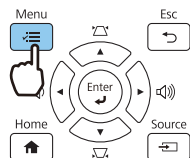

3 Use the up and down buttons to select **Save Memory**, and then press the [Enter] button to confirm the selection.

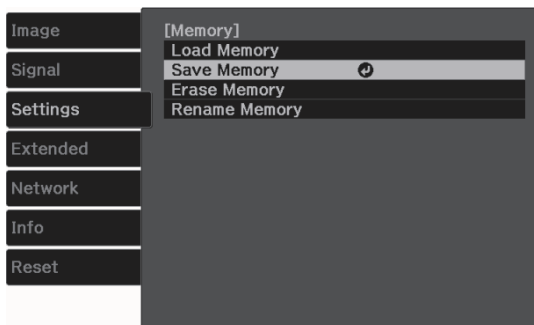

4 Use the up and down buttons to select the memory name you want to save, and then press the [Enter] button to confirm the selection.

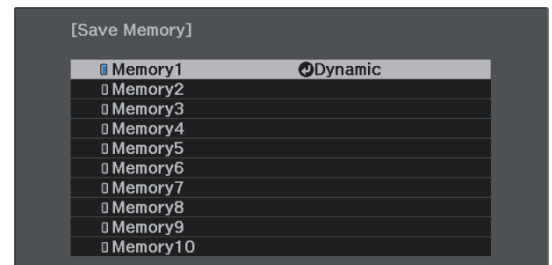

The current projector settings are saved to the memory.

If the mark on the left of the memory name is turned aqua, it means the memory has already been registered. When you select a registered memory, a message is displayed asking you to confirm that you want to overwrite the memory. If you select **Yes**, the previous content is erased and the current settings are saved.

Loading, Deleting, and Renaming a Memory

You can load, delete, and rename registered memories.

- 1 Press the [Menu] button to display menus in the order **Settings - Memory**.

Remote control

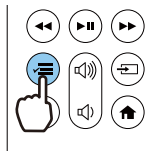

Control panel

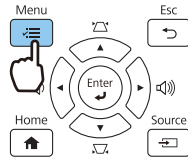

- 2 Select the target function on the screen displayed.

Function	Explanation
Load Memory	Loads the saved memory. When you select a memory and press the [Enter] button, the settings applied to the current image are replaced with the settings from the memory.
Erase Memory	Erases a saved memory. When you select a memory name and press the [Enter] button, a message is displayed. Select Yes , and then press the [Enter] button to erase the selected memory.
Rename Memory	Changes the memory name. Select the memory name you want to change, and then press the [Enter] button. Enter the memory name using the soft keyboard. p.69 When you have finished, move the cursor over Finish, and then press the [Enter] button.

Enjoying 3D Images

Preparing to View 3D Images

To view 3D images, be sure to prepare a pair of commercially available 3D Glasses with an active shutter system that supports radio waves (RF/Bluetooth) communication system in advance.

Check the following before viewing 3D images.

- The source is HDMI1/HDMI2/HDMI3
- **3D Display** is set to **Auto** or **3D**
 - **Signal - 3D Setup - 3D Display** p.62
- Pair 3D Glasses.

This projector supports the following 3D formats.

- Frame Packing
- Side by Side
- Top and Bottom

■ If the 3D image cannot be viewed

The projector automatically projects a 3D image when detecting a 3D format.

Some 3D TV broadcasts may not contain 3D format signals. If this happens, follow the steps below to set the 3D format.

1 Press the [Menu] button to display menus in the order **Signal - 3D Setup**.

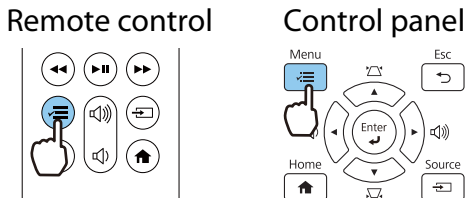

2 Set **3D Display** to **3D**.

3 Press the [Esc] button to return to the previous screen.

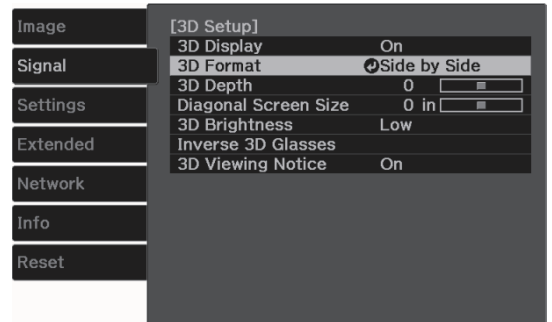

4 Select **3D Format**, and then select the 3D format on the AV device.



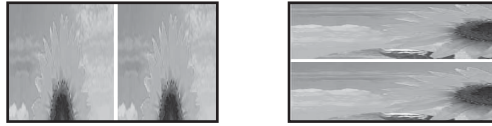

- If you are using a device or cable that does not support 3D images, 3D projection cannot be performed.
- For details on 3D format settings on the AV device, see the documentation supplied with the AV device.
- When the 3D format has not been correctly set up, an image will not be correctly projected as shown below.



- If a 3D image is not projected correctly even when a 3D format is set, the synchronization timing for the 3D Glasses may be inverted. Inverse the synchronization timing using **Inverse 3D Glasses**.
 **Signal - 3D Setup - Inverse 3D Glasses** [p.62](#)
- How a 3D image is perceived varies depending on the individual.
- When you start projecting a 3D image, a warning about viewing 3D images is displayed. You can turn off this warning by setting **3D Viewing Notice** to **Off**.  **Signal - 3D Setup - 3D Viewing Notice** [p.62](#)
- During 3D projection, the following Configuration menu functions cannot be changed.
4K Enhancement, Frame Interpolation, Aspect, Overscan (set to Off), Super-resolution, Image Processing, Advanced - Dynamic Range
- The appearance of the 3D image may change depending on the temperature of the surroundings. Refrain from using the projector if the image is not projected normally.

Using 3D Glasses

You can view 3D images by using a pair of commercially available 3D Glasses (with an active shutter system that supports radio waves (RF/Bluetooth) communication system).

To view 3D images, you first need to pair the 3D Glasses with the projector. See the User's Guide supplied with your 3D Glasses for more information.

Warnings Regarding Viewing 3D Images

Note the following important points when viewing 3D images.

Caution

Viewing Time

- When viewing 3D images, always take periodic breaks during extended viewing.
Long periods of viewing 3D images may cause eye fatigue.
The amount of time and frequency of such breaks varies from person to person. If your eyes still feel tired or uncomfortable even after taking a break from viewing, stop viewing immediately.

 **Caution**

Watching 3D Images

- If your eyes feel fatigued or uncomfortable when viewing 3D images, stop viewing immediately. Continuing to view the 3D images could cause you to feel unwell.
- When viewing 3D images be sure to always wear 3D Glasses. Do not attempt to view 3D images without 3D Glasses. Doing so could cause you to feel unwell.
- Do not place any breakable or fragile objects around you when using 3D Glasses. 3D images may cause you to move your body involuntarily, resulting in damage to nearby items or personal injury.
- Only wear 3D Glasses when viewing 3D images. Do not move around while wearing 3D Glasses. Your vision may appear darker than normal, causing you to fall or injure yourself.
- Try to stay as level with the viewing screen as possible when viewing 3D images. Viewing 3D images at an angle reduces the 3D effect and may cause you to feel unwell due to unintended color changes.
- When viewing 3D images in a room with fluorescent or LED lighting, you may see flashing or flickering throughout the room. If this should occur, reduce the lighting until the flickering goes away or turn off the lights completely when viewing 3D images. In some very rare cases, this flickering could trigger seizures or fainting for some individuals. If you begin to feel uncomfortable or unwell at any time when viewing 3D images, stop immediately.
- Stay at least three times the height of the screen away from the screen when viewing 3D images. The recommended viewing distance for an 80-inch screen is at least 3 meters, and at least 3.6 meters for a 100-inch screen. Sitting or standing any closer than the recommended viewing distance may result in eye fatigue.

 **Caution**

Health Risks

- You should not use 3D Glasses if you are sensitive to light, have a heart condition, or are unwell. Doing so could aggravate your pre-existing conditions.

 **Caution**

Recommended Age of Use

- The minimum recommended age to view 3D images is six years old.
- Children under the age of six are still developing and viewing 3D images may cause complications. Consult your doctor if you have any concerns.
- Children viewing 3D images through 3D Glasses should always be accompanied by an adult. It is often difficult to tell when a child is feeling tired or uncomfortable, which could result in them feeling suddenly unwell. Always check with your child to ensure that they are not experiencing any eye fatigue during viewing.

Using the HDMI Link Function

HDMI Link Function

When an AV device that meets the HDMI CEC standards is connected to the projector's HDMI port, you can perform linked operations such as linked power on and volume adjustment for the AV system from one remote control.

- As long as the AV device meets the HDMI CEC standards, you can use the HDMI link function even if the AV system in-between does not meet the HDMI CEC standards.
- Up to 3 multi-media players that meet the HDMI CEC standards can be connected at the same time.

Connection Example

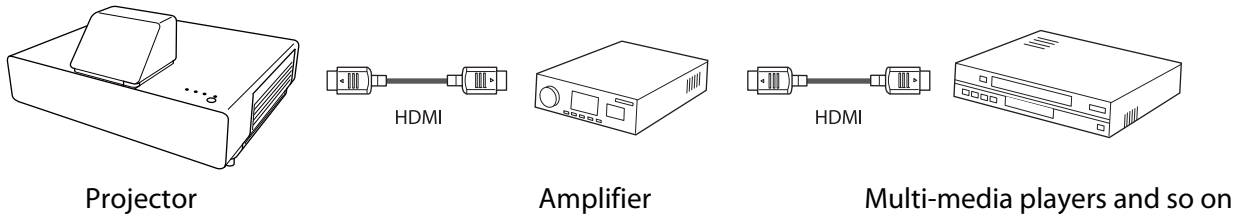

HDMI Link Settings

When **HDMI Link** is set to **On**, you can perform the following operations. **Settings - HDMI Link - HDMI Link p.63**

- Input Change Link**
Changes the input source of the projector to HDMI when content is played back on the connected device.
- Connected Devices Operations**
Using the projector's remote control, you can perform operations such as Play, Fast Forward, Rewind, Pause, Volume Adjustment, and Audio Mute.

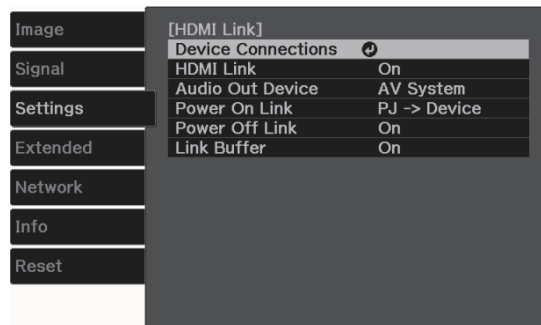

You can also select the following functions from the **HDMI Link** screen.

Function	Explanation
Audio Out Device	Selects which device outputs audio. Projector: Select this to output audio from the projector's built-in speakers or from an external speaker connected to the Audio Out port. AV System: Select this to output audio from an AV amplifier that supports the HDMI CEC standards.
Power On Link	When Power On Link is set, operations are linked as shown below. <ul style="list-style-type: none"> When the projector is turned on, the connected devices are also turned on. Also, when the connected devices are turned on and content is played back, the projector turns on.

Function	Explanation
Power Off Link	When Power Off Link is set to On , when the projector is turned off, the connected devices are also turned off. <ul style="list-style-type: none"> • This only works when the connected device's CEC power link function is enabled. • Note that depending on the status of the connected device (for example, if it is recording), the device may not power off.
Link Buffer	If HDMI Link is not working correctly, you may be able to improve it by changing the settings.



To use the HDMI Link function, you must configure the connected device. See the documentation supplied with the connected device for more information.

Connecting

You can check the connected devices that are available for HDMI Link, and select on the device you want to project the image from. Devices that can be controlled by HDMI Link automatically become the selected device.

Before displaying the list of connected devices, check that **HDMI Link** is set to **On**. **Settings - HDMI Link - HDMI Link p.63**

- 1 Press the [Menu] button to display menus in the order **HDMI Link - Device Connections**.

Remote control

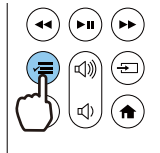

Control panel

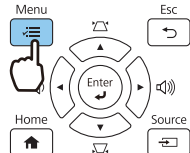

The **Device Connections** list is displayed.

Devices that have an aqua icon to their left are linked by HDMI Link.

If the device name cannot be determined this field is left blank.

- 2 Select the device you want to operate using the HDMI Link function.

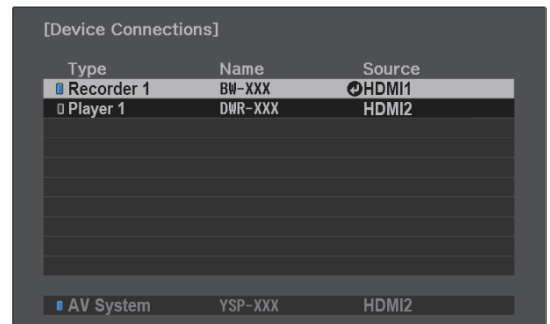

- If the cable does not meet the HDMI standards, operations are not possible.
- Some connected devices or functions of those devices may not operate properly even if they meet the HDMI CEC standards. See the documentation and so on supplied with the connected device for more information.

Projecting Using Wired LAN

You can send images to your projector through a wired network.

To do this, connect the projector to your network, and then set up your projector and computer for network projection.

When you have finished making projector connection and network settings, install Epson iProjection (Windows/Mac) from the following Web site.

You can use Epson iProjection to project computer images over a network. You can also hold dynamic meetings by projecting images from multiple computers connected to the network at the same time. See the Epson iProjection Operation Guide (Windows/Mac) for more information.

<https://www.epson.com>

Selecting Wired Network Settings

Before you can project images over a network, you need to connect the Wireless LAN unit (ELPAP10) and configure network settings on the projector.



Before making settings, connect a LAN cable to the LAN port, and connect the projector to the wired LAN.

1 Press the [Menu] button to display menus in the order **Network - Network Configuration**.

Remote control

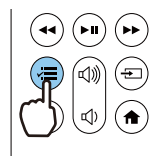

Control panel

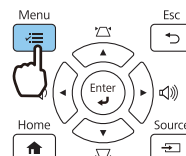

2 Select **Basic**, and then set the following as necessary.

- **Projector Name:** Enter a name up to 16 alphanumeric characters long to identify the projector over the network.
- **PJLink Password:** Set a password to use when you control the projector using compatible PJLink software. You can enter up to 32 single-byte alphanumeric characters.
- **Remote Password:** Set a password to use when you operate the projector from a smartphone or a tablet. You can enter up to single-byte 8 alphanumeric characters.
- **Display LAN Info.:** Set the display format for the projector's network information.



Use the displayed keyboard to enter the name, passwords and keyword. Use the up/down/left/right buttons on the remote control to select characters, and then press the [Enter] button to confirm the selection.

3 Select **Wired LAN**, and then press the [Enter] button.

- 4 Select the basic options as necessary.
 - If your network uses DHCP, set **DHCP** to **On**.
 - If you are not using DHCP, set **DHCP** to **Off**, and then enter the projector's **IP Address**, **Subnet Mask**, and **Gateway Address**.
- 5 When you have finished making settings, select **Complete** and follow the on-screen instructions to save your settings and exit the menus.
- 6 Press the source button on the remote control or the [Source] button on the control panel, and then select **LAN**.

The settings are complete when you see the correct IP address on the LAN standby screen.



To prevent the IP address from being displayed on the LAN standby screen or the Home screen, set **IP Address Display** to **Off**. [☛ Network - Network Configuration - Wired LAN p.71](#)

Projecting Using Wireless LAN

You can project images from smartphones, tablets, and computers over wireless LAN.

To project over wireless LAN, you need to make wireless network settings for the projector and the connected device in advance.

Use Epson iProjection to project images over wireless LAN. You can download Epson iProjection using any of the following methods; however, the customer is liable for any costs involved.

- You can download Epson iProjection (Windows/Mac) from the following Web site.
<http://www.epson.com>
- You can download Epson iProjection (iOS/Android) from the App Store or Google Play.

Selecting Wireless Network Settings Manually

Before you can project from your wireless network, you need to select network settings for the projector.

1 Press the [Menu] button to display menus in the order **Network - Wireless LAN Power**.

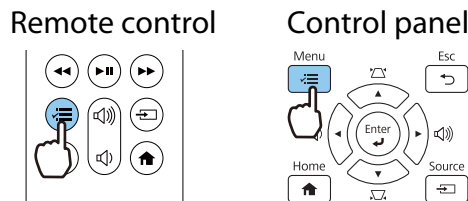

2 Use the up and down buttons to select **On**, and then press the [Enter].

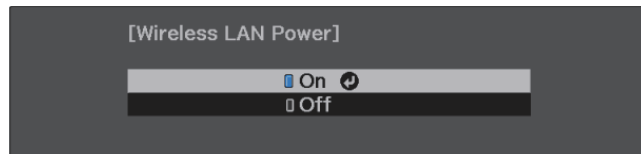

3 Select **Network Configuration**, and then press the [Enter] button.

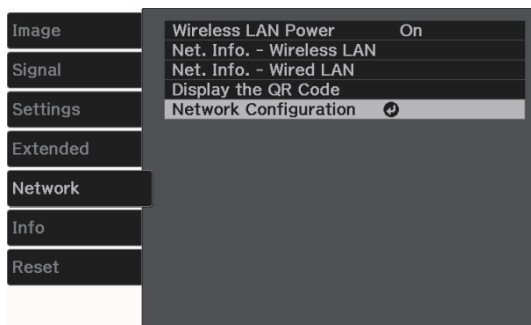

4 Select **Basic**, and then set the following as necessary.

- **Projector Name:** Enter a name up to 16 alphanumeric characters long to identify the projector over the network.
- **PJLink Password:** Set a password to use when you control the projector using compatible PJLink software. You can enter up to 32 single-byte alphanumeric characters.
- **Remote Password:** Set a password to use when you operate the projector from a smartphone or a tablet. You can enter up to single-byte 8 alphanumeric characters.
- **Display LAN Info.:** Set the display format for the projector's network information.

 Use the displayed keyboard to enter the name, passwords and keyword. Use the up/down/left/right buttons to select characters, and then press the [Enter] button to confirm the selection.

5 Select **Wireless LAN**, and then press the [Enter] button.

6 Select the **Connection Mode** setting.

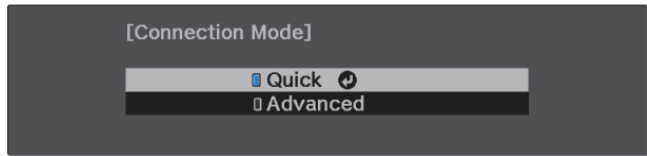

- **Quick:** Lets you connect the projector to your smartphones, tablets, or computers directly using wireless communication. When you select **Quick**, go to step 10.
- **Advanced:** Lets you connect to multiple smartphones, tablets, or computers over a wireless network access point. When you select **Advanced**, go to step 7.

7 Select **Network Configuration - Wireless LAN - Search Access Point**, to select the access point you want to connect to.

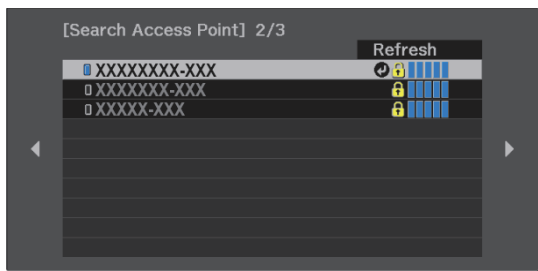

 If you need to assign the SSID manually, select **SSID** to enter the SSID. In addition, configure the security settings in the **Security** menu. [p.55](#)

- 8 Assign an IP address to the projector as necessary.
- If your network uses DHCP, select **IP Settings** to set the **DHCP** setting to **On**.
 - If you are not using DHCP, select **IP Settings** to set the **DHCP** setting to **Off**, and then enter the projector's **IP Address**, **Subnet Mask**, and **Gateway Address**.



- 9 When you have finished making settings, select **Complete** and follow the on-screen instructions to save your settings and exit the menus.

- 10 Press the source button on the remote control or the [Source] button on the control panel, and then select **LAN**.

The settings are complete when you see the correct IP address on the LAN standby screen.

When you have finished making wireless settings for your projector, you need to make wireless settings on the connected device. Then start the network software to send images to your projector through a wireless network.



To prevent the SSID and IP address from being displayed on the LAN standby screen or the Home screen, set **SSID Display** and **IP Address Display** to **Off**.  **Network - Network Configuration - Wireless LAN** [p.70](#)

Selecting the Computer's Wireless LAN Settings

To connect the computer and the projector using Advanced mode, select the correct wireless network settings on your computer.

Selecting wireless network settings in Windows

- 1 To access your wireless utility software, double-click the network icon on the Windows taskbar.
- 2 Select the network name (SSID) of the network the projector is connected to.
- 3 Click **Connect**.

Selecting wireless network settings in OS X

- 1 Click the AirMac icon on the menu bar at the top of the screen.
- 2 Make sure AirMac is turned on and select the network name (SSID) of the network the projector is connected to.

Setting Up Wireless Network Security

You can set up security for your projector to use on a wireless network. Set up one of the following **Connection Mode** to match the settings used on your network:

- WPA2 security
- WPA/WPA2 security

- 1 Press the [Menu] button to display menus in the order **Network - Network Configuration - Security**.

Remote control

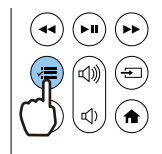

Control panel

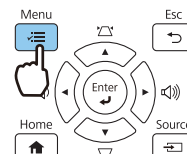

- 2 Select the security settings to match your network settings.

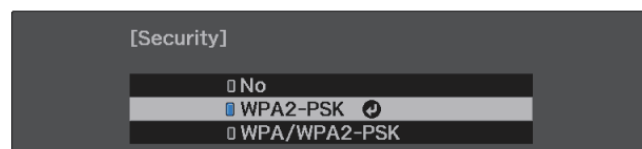

- When you have finished making settings, select **Complete** and follow the on-screen instructions to save your settings and exit the menus.

Projecting in Epson iProjection (iOS/Android)

You can display a QR code on the screen and project data easily from a smartphone or tablet using the Epson iProjection app (V3.2.0 or later).



- You can download Epson iProjection for free from the App Store or from Google Play. Any fees incurred when communicating with the App Store or Google Play are the responsibility of the customer.
- When using Epson iProjection in **Quick** connection mode, we recommend making security settings. [p.55](#)

- To display the QR code, press the [Menu] button, and then select **Network - Display the QR Code**.

Remote control

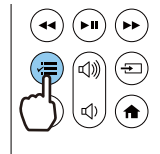

Control panel

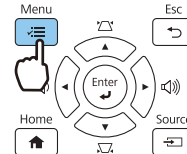

- If you press the [Home] button on the control panel or the home button on the remote control, you can also view the QR code from Connection Guide on the Home screen. [p.26](#)
- To hide the QR code, press the [Esc] button.

- Start Epson iProjection on your smartphone or tablet.

- Read the projected QR code on your smartphone or tablet.

Read the code from in front of the screen so that the QR code fits into the guide. If you are too far from the screen, the code may not be read.

Once connected, go to and select the **Contents** menu, and then select a file you want to project.

■ Operating using a smartphone (remote control function)

By using Epson iProjection, you can operate the projector from a smartphone or tablet.









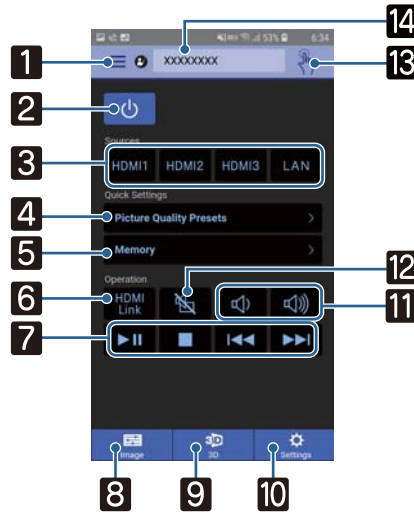





Tap  in Epson iProjection to display the menu.





Tap **Remote Control** on the menu to display the following screen.



When Remote Password is set, you need to enter the password. Once the password has been recognized, you do not need to enter it from the second time.



Button		Function
1		Displays the menu.
2		Turns the projector on or off.
3		Changes to the image from each input port.  p.25
4		Sets the image quality using the on-screen instructions.
5		Saves, loads, erases, or rename a memory.  p.43
6		Turns HDMI Link on or off.  p.48
7		When HDMI Link is On, you can perform operations such as Play, Stop, Fast Forward, Rewind, Next Chapter, Previous Chapter, and Pause.
8		Allows you to specify Color Mode, Frame Interpolation, Image Enhancement, Image Processing, Dynamic Contrast, Light Output, White Balance, Gamma, and RGBCMY.
9		Allows you to specify 3D Display, 3D Format, 3D Depth, Diagonal Screen Size, and 3D Brightness.
10		Allows you to specify Aspect, Keystone, Reset All, Reset Memory, Test Pattern, Zoom, Image Shift.
11		When HDMI Link is set to On, you can adjust the volume.

	Button	Function
12		When HDMI Link is set to On, you can turn the image and audio on/off temporarily.  p.32
13		Opens the touch pad screen. You can operate the projector's menu screens by touching your touch pad.
14		Selects the projector you want to control.

Configuration Menu Functions

Configuration Menu Operations

On the Configuration menu, you can make adjustments and settings for Signal, Image, Input Signal, and so on.

1 Press the [Menu] button.

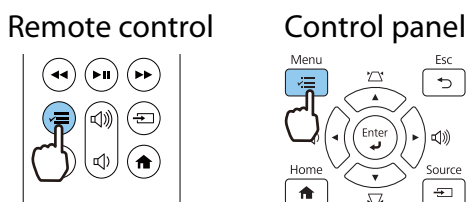

The Configuration menu is displayed.

2 Use the up and down buttons to select the top menu on the left, and then press the [Enter] button to confirm the selection.

When you select the top menu on the left, the sub menu on the right changes.

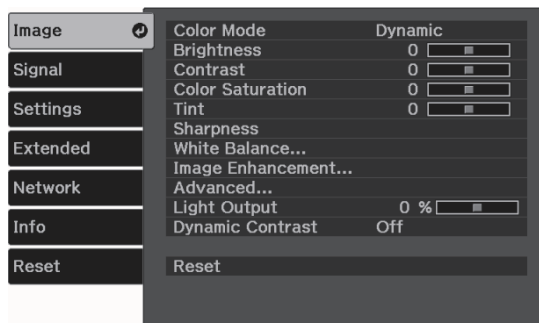

The line at the bottom is a guide for operations.

3 Use the up and down buttons to select the sub menu on the right, and then press the [Enter] button to confirm the selection.

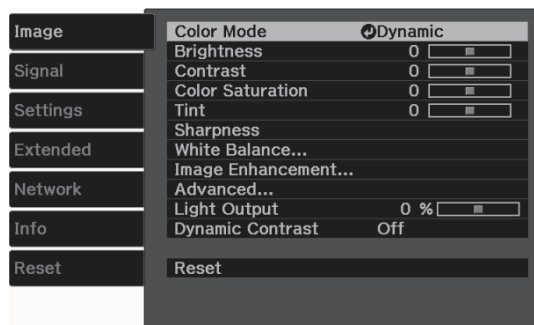

The adjustment screen for the selected function is displayed.

4 Use the up/down/left/right buttons to adjust the settings.

Ex.) Adjustment bar



Ex.) Choices

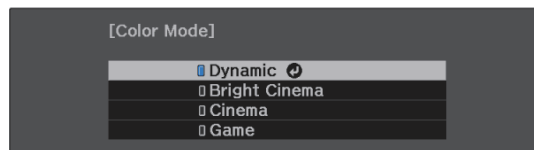

Press the [Enter] button on an item displaying this icon to change to the selection screen for that item.









Press the [Esc] button to return to the previous level.







5 Press the [Menu] button to exit the menu.

Configuration Menu Table

If there is no image signal being input, you cannot adjust items related to the **Image** or **Signal** in the Configuration menu. Note that the items displayed for the **Image**, **Signal**, and **Info** vary depending on the image signal being projected.

■ Image menu

Function	Menu/Settings		Explanation
Color Mode	Dynamic, Bright Cinema, Cinema, Game		Select a color mode based on your surroundings and the image you are projecting.  p.33
Brightness			Adjusts the brightness when the image appears too dark.
Contrast			Adjusts the contrast between light and shade in the images. By increasing the contrast, the images become vivid.
Color Saturation			Adjusts the color saturation for the images.
Tint			Adjusts the tint for the images.
Sharpness			Adjusts the image sharpness.
White Balance	Color Temp.		Adjusts the tint for the images. The image is tinted blue for high values, and tinted red for low values.
	G-M Correction		The image becomes greener when set to a positive value and redder when set to a negative value.
	Custom		Adjusts the offset and gain for each R, G, and B color.
	Grayscale	Adjustment Level, Red, Green, Blue, Brightness	Adjusts red, green, blue, and brightness for the selected adjustment level.



Function	Menu/Settings		Explanation
Image Enhancement*1	4K Enhancement	On, Off	You can project at a doubled resolution.
	Image Preset Mode	Off, Preset 1 to Preset 5	Select the settings prepared in advance as the settings for Frame Interpolation , Deinterlacing , Noise Reduction , MPEG Noise Reduction , Super-resolution , and Detail Enhancement .
	Frame Interpolation	Off, Low, Normal, High	Adjusts the smoothness of movement of the image.
	Deinterlacing	Off, Video, Film/Auto	(This can only be set when Image Processing is set to Fine or when receiving a 480i, 576i, or 1080i signal input from the HDMI1/HDMI2/HDMI3 ports.) Converts the signal from interlaced (i) to progressive (p) using a method appropriate for the image signal. <ul style="list-style-type: none"> • Off: This is ideal for dynamic motion images. • Video: This is ideal for viewing general video images. • Film/Auto: Performs the optimal conversion for film, CG, or animation input signals.
	Noise Reduction		Adjusts the roughness of the image.
	MPEG Noise Reduction		Smooths out rough images in MPEG format.
	Super-resolution	Fine Line Adjust, Soft Focus Detail	Adjusts the amount of enhancement for complicated images and backgrounds.
	Detail Enhancement	Strength, Range	Creates a more emphatic texture and material feel of the image.
Advanced	Gamma	2, 1, 0, -1, -2, Custom*2, Reset	Performs gamma adjustments. You can select a raw value or adjust using a custom value.  p.41
	RGBCMY	R/G/B/C/M/Y	Hue, Saturation, Brightness  Adjusts the Hue, Saturation, and Brightness for each R, G, B, C, M, and Y color.  p.40
Light Output			Sets the brightness for the light source.
Dynamic Contrast	Off, Normal, High Speed		Adjusts the projection luminance according to the brightness of the image.  p.37
Reset	Yes, No		Resets the adjustment values of Image set in the current Color Mode to the default settings.

*1 Only when an HDMI1, HDMI2, or HDMI3 image signal is being input.

*2 Settings are saved for each type of input source or Color Mode.

■ Signal menu

The Signal menu cannot be set when a LAN image signal is being input.









Function	Menu/Settings		Explanation
3D Setup	3D Display	Auto, 3D, 2D	To view 3D images, set this to Auto or 3D .  p.45
	3D Format	Side by Side, Top and Bottom	Sets the 3D format for the input signal.
	3D Depth	-10 to 10	Sets the depth for the 3D image.
	Diagonal Screen Size	60 to 300	Sets the projection size for the 3D image. By matching this to the actual size, you can achieve the optimum 3D effect.
	3D Brightness	Low, Medium, High	Sets the brightness for the 3D image.
	Inverse 3D Glasses		Reverses the synchronization timing for the left/right shutters on the 3D Glasses and the left/right images. Enable this function if the 3D effect is not displayed correctly.
	3D Viewing Notice	On, Off	Turns the notice that appears when viewing 3D content on or off.
Aspect*1	Auto*2, Normal, Full, Zoom		Selects the aspect mode.  p.33
Overscan*1	Auto, Off, 4%, and 8%		Changes the output image ratio (the range of the projected image). <ul style="list-style-type: none"> • Off, 4%, 8%: Sets the range of the image. When set to Off, the entire range of the image is projected. Depending on the image signal, you may notice noise at the top and bottom of the image. • Auto: Automatically sets to Off or 8% depending on the input signal.
Color Space	Auto, BT.709, BT.2020		Sets the conversion system for the color space.
Dynamic Range	Dynamic Range	Auto, SDR, HDR10, HLG	Lets you change the range of dark and bright areas in images.
	Signal Status	-	Displays the image signal.
	HDR10 Setting	1 to 16	Lets you change the PQ curve of the dynamic range in the HDR PQ method.
	HLG Setting	1 to 16	Lets you change the HLG curve of the dynamic range in the HDR HLG method.



Function	Menu/Settings		Explanation
Advanced	Video Range* ¹	Auto, Limited (16-235), Full (0-255)	When set to Auto , the video level for the DVD signal being input to the HDMI1/HDMI2/HDMI3 ports is automatically detected and set. If you experience under or overexposure when set to Auto , set the video level of the projector to match that of the DVD/Blu-ray disc player's video level. Your player may be set to Normal (Limited) or Expand (Full).
	EDID	Expanded, Normal, 21:9	Lets you change the EDID settings. Expanded supports 3840 x 2160 60 Hz signals, Normal supports 3840 x 2160 30 Hz signals, and 21:9 supports 2560 x 1080 60 Hz signals.
	Image Processing	Fine, Fast	Improves the response speed for images projected at high-speed, such as games.
Reset	Yes, No		Resets all Signal settings except for Diagonal Screen Size , 3D Viewing Notice , and Aspect .

*1 Settings are saved for each type of input source or signal.

*2 You may not be able to make selections depending on the source or type of signal.

 Settings menu



Function	Menu/Settings		Explanation
Installation Guide	-		Displays a guide so that you can adjust the position during installation.
Keystone	H/V-Keystone	V-Keystone -12 to 12	Corrects keystone distortion.  p.30 <ul style="list-style-type: none"> H/V-Keystone: Manually corrects horizontal and vertical distortions.  p.30 Quick Corner: Corrects the corners of the projected image individually.  p.31
		H-Keystone -12 to 12	
	Quick Corner	-	
Blanking			Covers part of the image with a blank (black screen). You can set the top, bottom, left, or right of the image.
Zoom			Adjusts the size of the image.  p.28
Image Shift	-		Adjusts the position of the projected image without having to move the projector.  p.29
Volume			Adjusts the volume.

Function	Menu/Settings		Explanation
HDMI Link	Device Connections	-	Displays a list of devices connected to the HDMI1/HDMI2/HDMI3 ports.
	HDMI Link	On, Off	Enables or disables the HDMI Link function.
	Audio Out Device	Projector, AV System	Selects which device outputs audio.  p.48
	Power On Link	Off, Bidirectional, Device -> PJ, PJ -> Device	<p>Sets the link function when the power is turned on.</p> <ul style="list-style-type: none"> • When linking operations to the connected device and turning on the projector, select Bidirectional or Device -> PJ. • When linking power on for the projector to the connected device, select Bidirectional or PJ -> Device.
	Power Off Link	On, Off	Sets whether or not to power off connected devices when the projector is turned off.
	Link Buffer	On, Off	If HDMI Link is not working correctly, you may be able to improve it by changing the settings.
Lock Setting	Child Lock	On, Off	<p>This locks the standby button on the projector's control panel to prevent children from turning on the projector by accident. You can turn on the power when locked by holding down the standby button for approximately three seconds. You can still turn off the device using the standby button or perform operations with the remote control as usual.</p> <p>If changed, this setting is enabled after you power off the projector and the cool-down process is complete.</p> <p>Note that even if Child Lock is set to On, the projector still turns on when the power cord is connected if Direct Power On is set to On.</p>
	Control Panel Lock	Full Lock, Partial Lock, Off	<p>Full Lock: Disables all of the projector's buttons. Partial Lock: Disables all of the projector's buttons except for the standby button.</p> <p> is displayed on the screen if buttons are pressed while the projector is locked. To unlock, press and hold the [Enter] button on the control panel for at least 7 seconds.</p> <p>If changed, this setting is enabled once you close the Configuration menu.</p>

Function	Menu/Settings		Explanation
Memory	Load Memory	Memory1 to Memory10	Loads the settings saved in Save Memory to adjust the image.
	Save Memory	Memory1 to Memory10	Saves the settings made in Image to a memory.
	Erase Memory	Memory1 to Memory10	Erases a saved memory.
	Rename Memory	Memory1 to Memory10, Default, DVD, VCR, SDTV, HDTV, Cinema, Sports, Music, Anime, Game, Custom	Changes the saved memory name.
Reset	Yes, No		Resets the adjustment values for Keystone , Blanking , Volume , HDMI Link , and Lock Setting .

■ Extended menu

Function	Menu/Settings		Explanation
Home Screen	Home Screen Auto Disp.	On, Off	Selects whether or not to display the Home screen automatically when the projector turns On . The Home screen is not displayed when the selected source has an image signal when the projector turns on.
	Custom Function 1	Dynamic Contrast, Keystone, Info, Installation Guide	Select the function assigned to the Home screen.
	Custom Function 2		

Function	Menu/Settings		Explanation	
Display	Messages	On, Off	<p>Sets whether or not to display the following messages (On or Off).</p> <ul style="list-style-type: none"> • Item names for image signals, color modes, and aspect ratios. • If the internal temperature is rising when no image signal is being input or an unsupported signal is detected. 	
	Display Background	Black, Blue, Logo	Selects the screen status when no image signal is being input.	
	Startup Screen	On, Off	Sets whether or not to show a startup screen when projection begins (On or Off). If changed, this setting is enabled after you power off the projector and the cool-down process is complete.	
	Standby Confirmation	On, Off	Sets whether or not to display a standby confirmation message (On or Off).  p.27	
	Panel Alignment	-	 p.68	
	Color Uniformity	Color Uniformity	On, Off	Enables or disables Color Uniformity.
		Adjustment Level		There are eight levels from white, through gray, and up to black. You can adjust each level individually.
		Start Adjustments	Red, Green, Blue	Starts making Color Uniformity adjustments.
Reset		Yes, No	Resets all adjustments and settings for Color Uniformity to their default values.	
Projection	Front, Front/Upside Down		Change this setting depending on how the projector is installed.	

Function	Menu/Settings		Explanation
Operation	Direct Power On	On, Off	You can set up the projector so that projection starts as soon as the power cord is plugged in without any button operations. Note that when this is set to On , projection starts if power is restored after a blackout or other power outage and the power cord is still plugged into the projector.
	Sleep Mode	On, Off	If the set time is exceeded and no signal is input, the projector is automatically turned off and enters standby mode. When in standby mode, press the power button on the remote control or the standby button on the control panel to re-start projection.
	Sleep Mode Timer	1 to 30 mins.	Sets the interval for Sleep Mode .
	Illumination	On, Off	Set this to Off if the light from the indicators on the control panel bother you when watching a movie in a dark room.
	High Altitude Mode	On, Off	Set this to On if you are using the projector above an altitude of 1500 meters.
	Quick Startup	Off, 20min., 60min., 90min.	Set how long you want to Quick Startup mode to be available. Turn off the projector to enter Quick Startup mode. In Quick Startup mode, you can project within seconds of pressing the power button. In Quick Startup mode, the standby power consumption increases.
	USB Power in Standby (only some countries and regions)	On, Off	When set to On , power is also supplied to the streaming media player from the USB power cable when the projector is in standby mode (power off). If the internal temperature of the projector gets too hot, power may stop automatically.
	Log Save Destination	Internal Memory, USB and Internal Memory	Set where you want to save the logs.
Standby Mode	Communication Off, Communication On		Communication On indicates that the projector can be monitored over a network when the projector is in standby mode.
Language	-		Selects the display language.
Reset	Yes, No		Resets all Extended settings except for Memory, Projection, High Altitude Mode, Standby Mode, USB Power in Standby and Language .

Panel Alignment menu

Menu/Settings			Explanation	
Panel Alignment	Panel Alignment	On, Off	Enables or disables Panel Alignment.	
	Select Color	R, B	Select the color to correct.	
	Pattern Color	R/G/B, R/G, G/B	Select the pattern used for correction.	
	Start Adjustments	-	Starts Panel Alignment.  p.90	
	Memory	Load Panel Alignment	Memory1, Memory2, Memory3	Loads settings saved using the Save Panel Alignment function.
		Save Panel Alignment	Memory1, Memory2, Memory3	Saves the settings made in Panel Alignment to a memory.
		Erase Panel Alignment	Memory1, Memory2, Memory3	Erases memories registered using the Panel Alignment function.
Rename Panel Alignment		Memory1, Memory2, Memory3	Renames Panel Alignment memories.	
Reset	Yes, No	Resets the correction value.		

 Network menu

Function	Menu/Settings	Explanation
Wireless LAN Power	On, Off	Sets whether or not (On or Off) to use Wireless LAN Power.
Net. Info. - Wireless LAN	-	Displays the following network settings. <ul style="list-style-type: none"> • Connection Mode • Wireless LAN system • Antenna Level • Projector Name • SSID • DHCP • IP Address • Subnet Mask • Gateway Address • MAC Address • Region Code
Net. Info. - Wired LAN	-	Displays the following network settings. <ul style="list-style-type: none"> • Projector Name • DHCP • IP Address • Subnet Mask • Gateway Address • MAC Address

Function	Menu/Settings	Explanation
Display the QR Code	-	Displays network information for the projector with a QR code.
Network Configuration	-	Displays the screen to set the network.  p.69

Notes on operating the Network menu

Basic operations are made in the same way as when using the Configuration menu.

However, be sure to select the **Complete** menu to save your settings when done.



- Yes:** Saves the settings and exits the Network menu.
- No:** Exits the Network menu without saving the settings.
- Cancel:** Continues displaying the Network menu.

Soft keyboard operations

In the Network menu, the soft keyboard appears when you need to enter numbers and characters. Use the up/down/left/right buttons on the remote control or control panel to select keys, and then press the [Enter] button to input the text. Press **Finish** to confirm your input, or **Cancel** to cancel your input.





- CAPS key:** Switches between uppercase and lowercase letters.
- SYM1/2 key:** Switches the symbol keys.

Basic menu

Function	Menu/Settings	Explanation
Projector Name	Up to 16 alphanumeric characters	Enter a name to identify the projector over a network.
PJLink Password	Up to 32 alphanumeric characters	Set a password to use when you control the projector using compatible PJLink software.  p.94
Remote Password	Up to 8 alphanumeric characters	Set a password to use when you operate the projector from a smartphone or a tablet.
Display LAN Info.	Text & QR Code, Text	Set the display format for the projector's network information.

Wireless LAN menu

Function	Menu/Settings	Explanation
Connection Mode	Quick, Advanced	Determines how the wireless LAN is connected. Quick: Using Epson iProjection allows you to connect to smartphones, tablets, or computers directly using wireless communication. The projector becomes a simple access point. (Make sure the number of devices connected to the projector is six or less. It may take longer to update the projected image if the number of connected devices exceeds this number.) Advanced: Lets you connect to multiple smartphones, tablets, or computers over a wireless network access point.
Channel*1	1ch, 6ch, 11ch	Select the frequency bandwidth used by the wireless LAN.
SSID*2	Up to 32 alphanumeric characters	Enter an SSID. When an SSID is provided for the wireless LAN system in which the projector participates, enter the SSID.
Search Access Point*2	To Search View	Search for available wireless network access points.  indicates currently connected access points.  indicates the access points where security is set. If you select an access point that has security enabled, Security menu appears.  p.70
IP Settings*2	DHCP	Set whether or not (On/Off) to use DHCP. If this is set to On , you cannot set any more addresses.
	IP Address	Inputs the IP address for the projector. The following IP addresses cannot be used. 0.0.0.0, 127.x.x.x, 224.0.0.0 to 255.255.255.255 (where x is a number from 0 to 255)
	Subnet Mask	Enter the projector's subnet mask. The following subnet masks cannot be used. 0.0.0.0, 255.255.255.255
	Gateway Address	Enter the projector's gateway IP address. The following gateway addresses cannot be used. 0.0.0.0, 127.x.x.x, 224.0.0.0 to 255.255.255.255 (where x is a number from 0 to 255)
SSID Display	On, Off	Sets whether or not to display the SSID on the LAN Standby screen and the Home screen (On or Off).
IP Address Display	On, Off	Sets whether or not to display the IP address on the LAN Standby screen and the Home screen (On or Off).

*1 This can only be set when **Connection Mode** is set to **Quick**.

*2 This can only be set when **Connection Mode** is set to **Advanced**.

Security menu

Function	Menu/Settings	Explanation
Security	No, WPA2-PSK, WPA/WPA2-PSK	Sets the security. In Quick , WPA2-PSK is selectable. In Advanced , WPA2-PSK/WPA/WPA2-PSK is selectable.
Passphrase	From 8 to 32 single-byte alphanumeric characters	Inputs the passphrase. It is recommended to change the passphrase periodically for the purpose of security.

Wired LAN menu

Function	Menu/Settings	Explanation
DHCP	On, Off	Set whether or not (On/Off) to use DHCP. If this is set to On , you cannot set any more addresses.
IP Address	Number from 0 to 255	Enter the IP address assigned to the projector. You can enter a number from 0 to 255 in each field of the address. However, the following IP addresses cannot be used. 0.0.0.0, 127.x.x.x, 224.0.0.0 to 255.255.255.255 (where x is a number from 0 to 255)
Subnet Mask	Number from 0 to 255	Enter the projector's subnet mask. You can enter a number from 0 to 255 in each field of the address. However, the following subnet masks cannot be used. 0.0.0.0, 255.255.255.255
Gateway Address	Number from 0 to 255	Enter the projector's gateway IP address. You can enter a number from 0 to 255 in each field of the address. However, the following gateway addresses cannot be used. 0.0.0.0, 127.x.x.x, 224.0.0.0 to 255.255.255.255 (where x is a number from 0 to 255)
IP Address Display	On, Off	Set to Off to prevent the IP address from being displayed on the Net. Info. - Wired LAN screen.

Others menu

Function	Menu/Settings	Explanation
PJLink Notifica- tion	On, Off	To use the notification function of PJLink, select On .
Notified IP Ad- dress	Number from 0 to 255	Enter the IP address of a computer to be notified of the projector's operating status using the PJLink notification function. You can enter numbers from 0 to 255. The following IP addresses cannot be used. 127.x.x.x, 224.0.0.0 to 255.255.255.255 (x is a number from 0 to 255)
AMX Device Dis- covery	On, Off	When you want to allow the projector to be detected by AMX Device Discovery, set this to On . Set this to Off if you are not connected to an environment controlled by a controller from AMX or AMX Device Discovery.
Control4 SDDP	On, Off	When you want to allow the projector to be detected by Control4 SDDP, set this to On . Set this to Off if you are not connected to an environment controlled by a controller from Control4 or Control4 SDDP.

Reset menu

Function	Explanation
Reset network settings.	You can reset all adjustment values for Network to their default settings.

Info menu

Function	Menu/Settings	Explanation
Projector Info	Operation Hours	Displays the usage time since the projector was turned on.
	Source	Displays the current input source.
	Input Signal*	Displays the input signal setting of the current input source.
	Resolution*	Displays the resolution.
	Scan Mode*	Displays the scan mode.
	Refresh Rate*	Displays the refresh rate.
	3D Format*	Displays the 3D format of the signal input during 3D projection (Side by Side or Top and Bottom).
	Sync Info*	Displays the image signal information. This information may be needed if service is required.
	Color Depth*	Displays the color depth and color difference.
	Color Format*	Displays information on the Color Space and Dynamic Range.
	Status	This is information about errors that have occurred on the projector. This information may be needed if service is required.
	Serial Number	Displays the projector's serial number.
	Event ID	The application error log appears.  p.85
Light Source Info	Light Source Hours	Displays the light source usage time.
Version	Main	Displays the firmware version of the projector.
	Video2	

* This is not displayed when a LAN image signal is being input.

Reset menu

Function	Explanation
Reset Memory	Resets all items for Memory to their default settings.
Reset All Config	Resets all items in the Configuration menu to their default settings. The following adjustment values are not reset to their defaults: Zoom, Image Shift, Memory, Panel Alignment, Color Uniformity, Operation Hours, Language and Network Settings .

Problem Solving

Handling Problems

If the projector is not operating correctly, turn off the power, reconnect the power cord, and then turn it on again.

If this does not solve the problem, check the following points.

- Use the indicators to check the status of the projector.
- See the list of problems in this guide for information on solving problems.

If you cannot solve the problem, contact your local dealer or the contact information provided in the Epson Projector Contact List.

Reading the Indicators

You can check the status of the projector from the flashing and lit Indicators on the control panel.

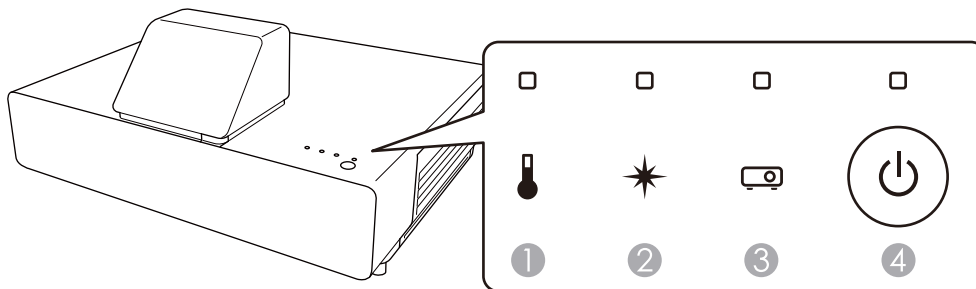

- ① Temperature indicator
- ② Laser indicator
- ③ Status indicator
- ④ Standby indicator

Refer to the following table to check the projector's status and how to remedy problems shown by the indicators.

Indicator status during an error/warning

◻ : Lit ◻ : Flashing ◻ : Status dependent ◻ : Off

Indicators	Status	Remedy
	High Temp Warning	<p>You can continue projecting. If the temperature rises too high again, projection stops automatically.</p> <ul style="list-style-type: none"> • Make sure that the air filter and exhaust vents are not blocked, and that air flow is not being blocked by any objects or walls around the projector. • If the air filter is clogged, clean or replace it. p.86, p.88 • Make sure that nothing is blocking the area around the inlet and that the temperature around the inlet is not too high. p.101
	Internal Error	<p>The projector has malfunctioned. Remove the power plug from the electrical outlet, and contact your local dealer or the nearest Epson repair center. Epson Projector Contact List</p>
	Fan Error Sensor Error	
	Laser Warning	
	Laser Error	<p>A laser error has occurred. Remove the power plug from the electrical outlet, and contact your local dealer or the nearest Epson repair center. Epson Projector Contact List</p>
	High Temp Error (Overheating)	<p>The internal temperature is too high.</p> <ul style="list-style-type: none"> • The projector turns off automatically and you cannot project until it has cooled down. Wait for about five minutes. When the fan has stopped, disconnect the power cord. • Make sure that the air filter and exhaust vents are not blocked, and that air flow is not being blocked by any objects or walls around the projector. • If the air filter is clogged, clean or replace it. p.86, p.88 • Make sure that nothing is blocking the area around the inlet and that the temperature around the inlet is not too high. p.101 • If turning the power back on does not clear the problem, stop using the projector and remove the power plug from the electrical outlet. Contact your local dealer or the nearest Epson repair center. Epson Projector Contact List • When using at an altitude of 1500 m or more, set High Altitude Mode to On. Extended - Operation - High Altitude Mode p.65

Indicator status during normal operation

◻ : Lit ◻ : Flashing ◻ : Status dependent ◻ : Off

Indicators	Status	Remedy
	Standby condition	<p>When you press the power button on the remote control, or the standby button on the control panel, projection starts after a short wait.</p> <p>When Standby Mode is set to Communication On, the standby indicator remains on even when the projector is standing by.</p>
	Warm-up in progress	<p>Warm-up time is about 30 seconds.</p> <p>The power-off operation is disabled while the projector is warming-up.</p>
	Cool-down in progress	All operations are disabled while the projector is cooling-down.
	Projection in progress	The projector is operating normally.



- Under normal operating conditions, the temperature and laser indicators are off.
- When the **Illumination** function is set to **Off**, all indicators are off under normal projection conditions.
 - ➔ **Extended - Operation - Illumination** [p.65](#)

When the Indicators Provide No Help

■ Check the problem



Check the following table to see if your problem is mentioned, and go to the appropriate page for information on handling the problem.

	Problem	Page
Problems relating to images	No images appear	p.77
	Projection does not start, the projection area is completely black, or the projection area is completely blue.	
	Moving images are not displayed	p.77
	"Not supported" is displayed	p.77
	"No Signal" is displayed	p.78
	Keystone distortion of projected image	p.78
	Images are fuzzy or out of focus	p.78
	Interference/distortion appear in images	p.78
	Part of the image is truncated (large) or small	p.79
	Image colors are not right	p.79
	The whole image appears purplish or greenish, images are black & white, or colors appear dull.*	
	Images appear dark	p.79
	Projection stops automatically	p.80
Noise problems	No audio, or the audio is too low	p.80
Problems when projection starts	The projector does not turn on	p.80
Problems with the remote control	The remote control does not respond	p.81
Problems with the control panel	Cannot make settings on the control panel	p.81
Problems with 3D	Cannot project correctly in 3D	p.81
Problems with HDMI	HDMI Link does not function	p.82
	The device name is not displayed under Device Connections	p.83
Problems with a streaming media player	Cannot view images from a streaming media player	p.83
Network problems	Cannot access the network via wireless LAN	p.83
	The settings cannot be modified using the remote controller function for Epson iProjection	p.83
	The image contains static during network projection	p.84

* Because color reproduction differs between monitors and computer LCD screens, the image projected by the projector and the color tones displayed on the monitor may not match, however this is not a fault.

■ Problems relating to images



No images appear

Check	Remedy
Is the power turned on?	Press the power button on the remote control or the standby button the control panel to turn on the projector.
Is the power cord connected?	Connect the power cord.
Are the indicators switched off?	Disconnect and then reconnect the projector's power cord. Check that pressing the power button after connection supplies the projector with power.
Is an image signal being input?	Check that the connected device is turned on. When Messages is set to On from the Configuration menu, image signal messages are displayed.  Extended - Display - Messages p.65
Has the power to the AV amplifier been disconnected?	If an AV amplifier is connected, check the AV amplifier's power supply.
Is an image signal being sent from the device?	Check that an image signal is being sent from the connected device.
Are the Configuration menu settings correct?	Reset all of the settings.  Reset - Reset All Config p.72
(Only when projecting computer image signals) Was the connection made while the power of the projector or the computer was already turned on?	If the connection is made while the power is already turned on, the Fn key (Function key) that changes the computer's image signal to external output may not work. Turn off the power for the computer and the projector and then turn it back on again.



Moving images are not displayed

Check	Remedy
(Only when projecting computer image signals) Is the computer's image signal set to external output and to output to the LCD monitor at the same time?	Depending on the computer's specifications, moving images may not be displayed when the computer is set to external output and to the LCD monitor output at the same time. Change it so that the image signal is set to external output only. For the computer's specifications, see the documentation supplied with the computer.

"Not supported" is displayed

Check	Remedy
(Only when projecting computer image signals) Do the image signal's frequency and resolution correspond to the mode?	Check the image signal being input in Resolution from the Configuration menu, and check that it matches the projector's resolution.  Info - Projector Info p.72  "Supported Resolutions" p.96



"No Signal" is displayed

Check	Remedy
Are the cables connected correctly?	Check that all the cables required for projection are securely connected.  p.18
Is the correct image input port selected?	Switch the image with the source buttons on the remote control.  p.25
Is the connected device turned on?	Turn on the device.
(Only when projecting computer image signals) Are the image signals being output to the projector?	Change it so that the image signal is set to external output, and not just the computer's LCD monitor. For some models, when the image signals are output externally, they no longer appear on the LCD monitor. For the computer's specifications, see the documentation supplied with the computer. If the connection is made while the power of the projector or the computer is already turned on, the Fn key (Function key) that changes the computer's image signal to external output may not work. Turn the power for the computer and the projector off and then back on again.

Keystone distortion of projected image

Check	Remedy
Is keystone distortion adjusted within the correction range?	If projecting the image from outside of the correctable range, you may not be able to correct the keystone distortion completely. Install the projector horizontally and parallel to the front of the screen as much as possible, and then adjust the projection position using Image Shift.  p.14

Images are fuzzy or out of focus

Check	Remedy
Has the focus been adjusted?	Adjust the focus.  p.28
Is the lens cap attached?	Remove the lens cap.
Is the projector at the correct distance?	Check the recommended projection range.  p.17
Has condensation formed on the lens?	If the projector is suddenly taken from a cold environment to a warm environment, or if sudden ambient temperature changes occur, condensation may form on the surface of the lens, and this may cause the images to appear fuzzy. Set the projector up in the room about one hour before it is used. If the projector is wet from condensation, turn off the projector, disconnect the power cord, and leave it for a while.

Interference or distortion appear in images

Check	Remedy
Are the cables connected correctly?	Check that all the cables required for projection are securely connected.  p.18

Check	Remedy
Is an extension cable being used?	If an extension cable is used, electrical interference may affect the signals.
(Only when projecting computer image signals) Is the correct resolution selected?	Set the computer so that the signals being output are compatible with the projector. 🖱️ p.96
Have you connected an AV system that does not support ARC?	If you connect an AV system that does not support ARC to the HDMI2 (ARC) port, the image may be distorted.

Part of the image is truncated (large) or small

Check	Remedy
Is the correct Aspect selected?	Select the aspect mode to match the input signal in Aspect from the Configuration menu. 🖱️ Signal - Aspect p.62
(Only when projecting computer image signals) Is the correct resolution selected?	Set the computer so that the signals being output are compatible with the projector. 🖱️ p.96

Image colors are not right

Check	Remedy
Are the cables connected correctly?	Check that all the cables required for projection are securely connected. 🖱️ p.18
Is the contrast adjusted correctly?	Adjust the Contrast setting from the Configuration menu. 🖱️ Image - Contrast p.60
Is the color adjusted correctly?	Adjust the Advanced setting from the Configuration menu. 🖱️ Image - Advanced p.60
(Only when projecting images from a video device) Are the color saturation and tint adjusted correctly?	Adjust the Color Saturation and Tint settings from the Configuration menu. 🖱️ Image - Color Saturation/Tint p.60

Images appear dark





Check	Remedy
Is the image brightness set correctly?	Adjust the Brightness setting from the Configuration menu. 🖱️ Image - Brightness p.60
Is the contrast adjusted correctly?	Adjust the Contrast setting from the Configuration menu. 🖱️ Image - Contrast p.60

Projection stops automatically

Check	Remedy
Is Sleep Mode enabled?	If the set time is exceeded and no signal is input, the laser is automatically turned off and the projector enters standby mode. Press the power button on the remote control or the standby button on the control panel to turn on the projector. If you want to disable Sleep Mode , change the setting to Off .  Extended - Operation - Sleep Mode p.65

 Noise problems

No audio, or the audio is too low

Check	Remedy
Is the audio cable connected correctly?	Try disconnecting the cable from the Audio Out port, and then reconnecting.
Is the volume too low?	Adjust the volume so that you can hear the audio.  p.32
Is it connected with an HDMI cable?	If no audio is output when connecting via an HDMI cable, set the connected equipment to PCM output.
Are the Audio Out Device settings correct?	Check that the Audio Out Device settings are correct on the Configuration menu.  Settings - HDMI Link - Audio Out Device p.63
Have you connected a streaming media player or video equipment?	Make sure that the volume for the streaming media player or the video equipment is high enough, and that the audio output settings are correct.
Have you connected an ARC compatible AV system?	Make sure that an ARC compatible AV system is connected to the HDMI2 port. Check that the following settings are correct on the Configuration menu. <ul style="list-style-type: none"> • Set Audio Out Device to AV System.  Settings - HDMI Link - Audio Out Device p.63 • When the AV System is connected to the projector, set HDMI Link to On.  Settings - HDMI Link p.63

 Problems when projection starts



The projector does not turn on

Check	Remedy
Is the power turned on?	Press the power button on the remote control or the standby button on the control panel to turn on the projector.
Is Child Lock set to On ?	When Child Lock is set to On from the Configuration menu, hold down the standby button on the control panel for approximately three seconds, or perform operations from the remote control.  Settings - Lock Setting - Child Lock p.63

Check	Remedy
Do the indicators turn on and off when the power cord is touched?	Turn off the projector, and then disconnect and reconnect the projector's power cord. If the problem continues, stop using the projector, remove the power plug from the electrical outlet, and contact your local dealer or the nearest projector information center.  Epson Projector Contact List

 Problems with the remote control

The remote control does not respond

Check	Remedy
Is the remote control light-emitting area pointing towards the remote receiver on the projector during operation?	Point the remote control towards the remote receiver. Also, check the operating range.  p.23
Is the remote control too far from the projector?	Check the operating range.  p.23
Is direct sunlight or strong light from fluorescent lamps shining onto the remote receiver?	Set the projector up in a location where strong light does not shine onto the remote receiver.
Are the batteries dead or have the batteries been inserted correctly?	Make sure the batteries are inserted correctly or replace the batteries with new ones if necessary.  p.23

 Problems with the control panel



Cannot make settings on the control panel

Check	Remedy
Is Control Panel Lock set to Full Lock or Partial Lock ?	When Control Panel Lock is set to Full Lock in the Configuration menu, all button operations on the control panel are disabled; when Partial Lock is set, only the standby button on the control panel is available. Perform operations from the remote control.  Settings - Lock Setting - Control Panel Lock p.63

 Problems with 3D



Cannot project correctly in 3D

Check	Remedy
Are the 3D Glasses turned on?	Turn on the 3D Glasses.
Are the 3D Glasses fully charged?	Charge the 3D Glasses.
Is a 3D image being projected?	If the projector is projecting a 2D image, or if an error occurs on the projector that prevents the 3D image from being projected, you cannot view 3D images even if you are wearing the 3D Glasses.
Is the input image in 3D?	Check that the input image is 3D compatible. Since most TV broadcasts do not contain a 3D format signal, 3D reception must be set manually.

Check	Remedy
Is 3D Display set to 2D ?	If 3D Display is set to 2D from the Configuration menu, the projector does not automatically change to 3D even when a 3D image is input. Set 3D Display to either 3D or Auto .  Signal - 3D Setup - 3D Display p.62
Is 3D Format set correctly?	Unless the 3D format of the AV device and 3D Format of the projector are the same, part of the image may not be displayed. Check that the projector's 3D Format setting matches the 3D format setting for the AV device.  Signal - 3D Setup - 3D Format p.62 Before changing the 3D Format , set 3D Display to 3D .
Are you viewing within the reception range?	If the distance between the projector and the 3D Glasses exceed 10 m, the connection may be lost. Move the 3D Glasses closer to the projector.
Has pairing been performed correctly?	See the user's guide supplied with your 3D Glasses and perform pairing.
Are there any devices that cause radio wave interference in the vicinity?	When using other devices at the same time with the frequency band (2.4 GHz) such as Bluetooth communication devices, wireless LAN (IEEE802.11b/g), or microwave ovens, radio wave interference may occur, the image may be interrupted, or communication may not be possible. Do not use the projector near these devices.

Problems with HDMI

HDMI Link does not function

Check	Remedy
Are you using a cable that meets the HDMI standards?	Operations are not possible with cables that do not meet the HDMI standards.
Does the connected device meet the HDMI CEC standards?	If the connected device does not meet the HDMI CEC standards, it cannot be operated even if it is connected to the HDMI port. See the documentation and so on supplied with the connected device for more information. Also, check if the device is available under Device Connections from the Configuration menu.  Settings - HDMI Link - Device Connections p.49
Are the cables connected correctly?	Check that all the cables required to use HDMI Link are securely connected.  p.48
Is the power for the amplifier or DVD recorder and so on turned on?	Put each device in standby status. See the documentation and so on supplied with the connected device for more information. If you have connected a speaker and so on, set the connected equipment to PCM output.
Was a new device connected, or was the connection changed?	If the CEC function for a connected device needs to be set again, for example when a new device is connected or the connection is changed, you may need to restart the device.
Are many multi-media players connected?	Up to 3 multi-media players that meet the HDMI CEC standards can be connected at the same time.

The device name is not displayed under Device Connections

Check	Remedy
Does the connected device meet the HDMI CEC standards?	If the connected device does not meet the HDMI CEC standards, it is not displayed. See the documentation and so on supplied with the connected device for more information.

Problems with a streaming media player

Cannot view images from a streaming media player

Check	Remedy
Is the streaming media player connected correctly?	Make sure that the streaming media player is connected correctly to the HDMI3 port using the HDMI extension cable and the USB power cable supplied.
Is the device connected to the Internet?	You need an Internet connection to view online content. Make sure you can connect to Wi-Fi.

Network problems

Cannot access the network via wireless LAN

Check	Remedy
Is Wireless LAN Power set to Off ?	Set Wireless LAN Power to On in the Configuration menu. If this is already set to On , set Wireless LAN Power to Off , and then set it to On again. Network - Wireless LAN Power p.68
Is the passphrase correct?	Note that the passphrase is case sensitive; upper case and lower case letters are treated as different characters. If you have forgotten your passphrase, set it again. Network - Network Configuration - Security - Passphrase p.70
Have you checked the Event ID?	Check the Event ID number and perform the following steps. Info - Projector Info - Event ID p.72 p.85

The settings cannot be modified using the remote controller function for Epson iProjection

Check	Remedy
Is the connected network device turned on?	When the projector is in the standby mode with Standby Mode set to Communication On , check to see if the connected network device is powered on. After powering on the network device, try starting the projector again. Extended - Standby Mode p.65

The image contains static during network projection

Check	Remedy
Are there any obstacles between the access point and the connected device?	Check for any obstacles between the access point, the mobile device, the computer, and the projector, and change their positions to improve communication.
Is the distance between the access point and the connected device too far?	Make sure that the access point, the mobile device, the computer, and the projector are not too far apart. Move them closer together and try to connect again.
Are there any Bluetooth devices or microwave oven in the vicinity?	If the wireless connection is slow or your projected image contains noise, check for interference from other equipment, such as a Bluetooth device or microwave. Move the interfering device farther away or expand your wireless bandwidth.
Are too many devices connected?	Reduce the number of connected devices if the connection speed declines.

About Event ID

Check the event ID and perform the remedy given below. If you cannot resolve the problem, contact your local dealer or the nearest Epson repair center.

☛ [Epson Projector Contact List](#)

Event ID	Cause	Remedy
0022 0027 0028 0029 0030 0031 0035 0434 0481 0482 0485	Network communication is unstable.	Check the network communication status, and reconnect after waiting for a while.
0432 0435	Failed to start the network software.	Restart the projector.
0433	An image that was transferred cannot be reproduced.	Restart the network software.
0484	Communications was cut off from the computer.	
04FE	The network software ended unexpectedly.	Check the status of network communications. Wait for a while and then try connecting again.
0479 04FF	A system error occurred in the projector.	Restart the projector.
0891	The same SSID access point cannot be found.	Set the computer, the access point, and the projector to the same SSID.
0892	WPA and WPA2 authentication type mismatch.	Check the setting of wireless LAN security to see if it is correct.
0894	Communications was cut off because a connection was made to the wrong access point.	Check with the network administrator and follow their instructions.
0898	Failed to acquire the DHCP.	Check that the DHCP server is operating correctly. Turn off the DHCP setting if you are not using DHCP. ☛ Network - Network Configuration - Wireless LAN - IP Settings - DHCP p.70
0020 0026 0032 0036 0037 0038 0899	Other connection errors	If restarting the projector or network software does not solve the problem, contact your local dealer or the nearest address provided in the Epson Projector Contact List. ☛ Epson Projector Contact List

Maintenance

Cleaning the Parts

You should clean the projector if it becomes dirty or if the quality of projected images starts to deteriorate.

Warning

Do not use sprays that contain flammable gas to remove dirt and dust from the projector's lens, air filter, and so on. The projector may catch fire due to the high internal temperature of the laser.

Cleaning the air filter

Clean the air filter if dust has accumulated on the air filter or when the following message is displayed. **"The projector is overheating. Make sure nothing is blocking the air vent, and clean or replace the air filter."**

Attention

- If dust collects on the air filter, it can cause the internal temperature of the projector to rise, and this can lead to problems with operation and shorten the optical engine's service life. We recommend cleaning the air filter every 20,000 hours. Clean them more often than this if using the projector in a particularly dusty environment.
- Do not rinse the air filter in water. Do not use detergents or solvents.
- Lightly brush the air filter to clean it. If it is brushed too strongly, dust will be ground into the air filter and cannot be removed.
- Do not use an air duster. Combustible material may remain, and dust may enter the precision parts.

- 1 Press the standby button on the remote control or the control panel to turn off the power, and then disconnect the power cord.

- 2 Lift the air filter side of the projector slightly to tilt it.

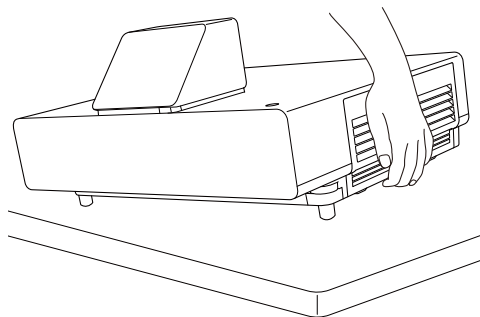

- 3 Loosen the fixing screws and open the air filter cover.

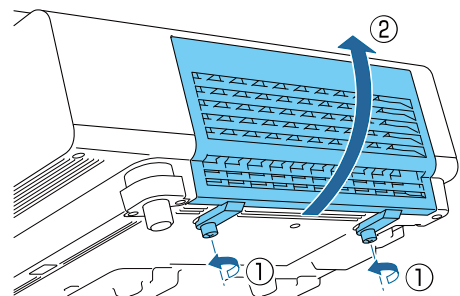

- 4** Remove the air filter.
Grip the knob in the center of the air filter and pull it out.

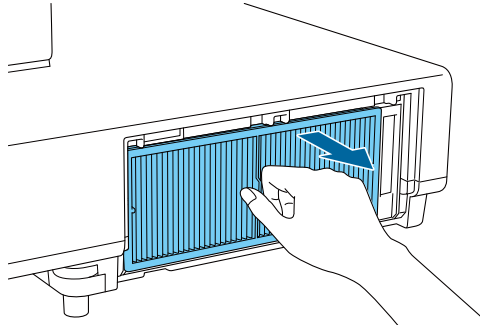

- 5** Hold the air filter with the surface facing down and tap it 4 or 5 times to remove the dust.

Turn it over and tap the other side in the same way.

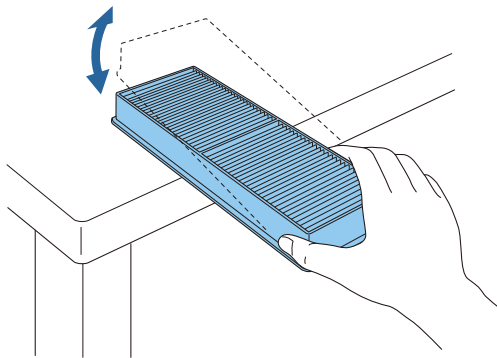

Attention

If the air filter is hit too hard, it may become unusable due to deformities and cracks.

- 6** Remove any dust remaining on the air filter by using a vacuum cleaner from the front side.

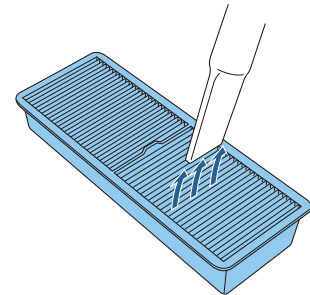

Attention

- Do not rinse the air filter in water. Do not use detergents or solvents.
- Do not use an air duster. Combustible material may remain, and dust may enter the precision parts.

- 7** Install the air filter.
Grip the air filter by the knob in the center and insert it straight.

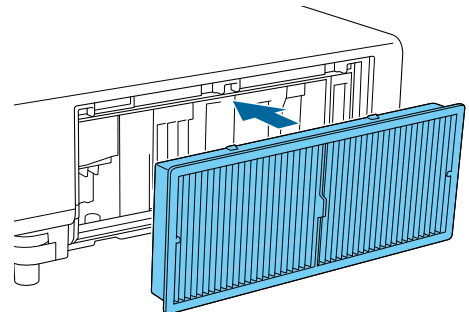

- 8** Close the air filter cover and tighten the fixing screws.

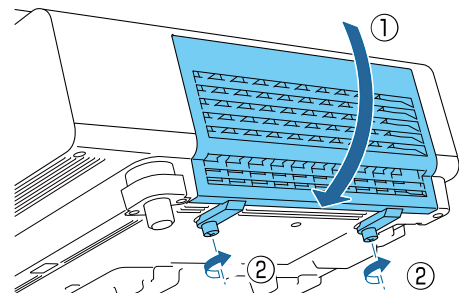

■ Cleaning the main unit

Before cleaning, make sure you unplug the charging adapter from the outlet.

Clean the projector's surface by wiping it gently with a soft cloth.

If it is particularly dirty, use a piece of well-wrung cloth moistened with water and wipe the surface again with a dry cloth.

Attention

Do not use detergent for kitchen or volatile substances such as wax, benzine and thinner to clean the projector's surface. The quality of the outer case may change or the paint may peel off.

■ Cleaning the lens

Before cleaning, make sure you unplug the charging adapter from the outlet.

Use a commercially available cloth for cleaning glasses to gently wipe off dirt from the lens.

Attention

- Do not rub the lens with harsh materials or handle the lens too roughly as it can easily become damaged.
- Do not use an air duster. Combustible material may remain, and dust may enter the precision parts.

Replacement Periods for Consumables

■ Air filter replacement period

If the replacement message is displayed even though the air filter has been cleaned  [p.86](#)

Replacing Consumables

■ Replacing the air filter



Dispose of used air filters properly in accordance with your local regulations.

- Filter frame: Polypropylene
- Filter: Polypropylene

- 1 Press the standby button on the remote control or the control panel to turn off the power, and then disconnect the power cord.

- 2** Lift the air filter side of the projector slightly to tilt it.

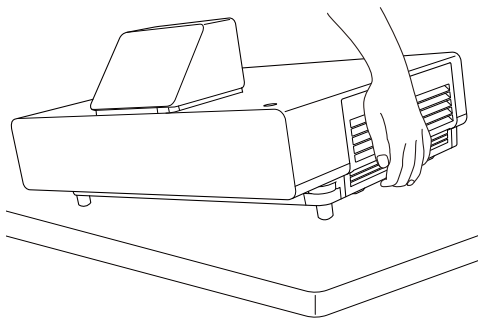

- 3** Loosen the fixing screws and open the air filter cover.

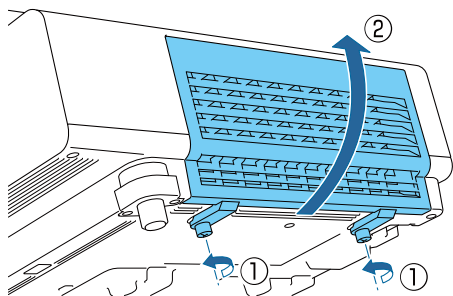

- 4** Remove the old air filter.
Grip the knob in the center of the air filter and pull it out.

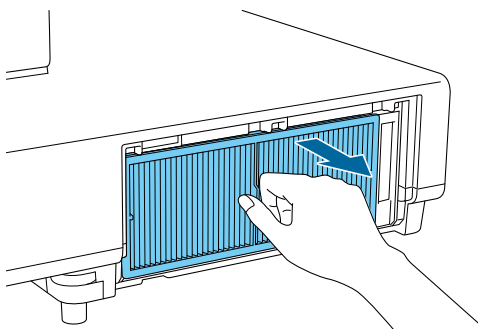

- 5** Install the new air filter.
Grip the air filter by the knob in the center and insert it straight.

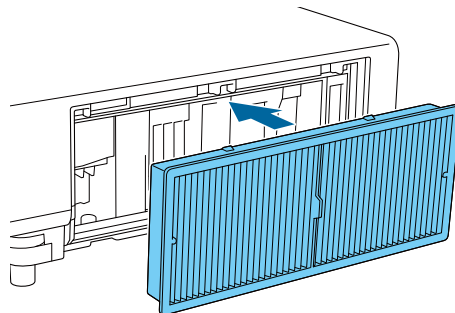

- 6** Close the air filter cover and tighten the fixing screws.

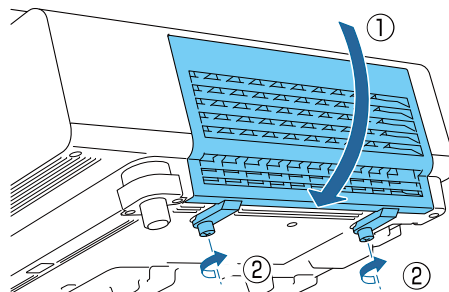

Panel Alignment

Adjusts the pixel color shift of the LCD display. You can adjust the pixels horizontally and vertically by 0.125 pixels within a range of ± 3 pixels.



- Image quality may decline after performing LCD alignment.
- Images for pixels that extend beyond the edge of the projected screen are not displayed.

- 1 Press the [Menu] button while projecting, and then select **Display** from **Extended**.

Remote control

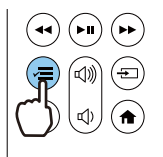

Control panel

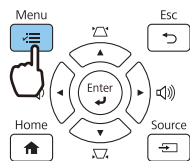

- 2 Select **Panel Alignment**, and then press the [Enter] button.

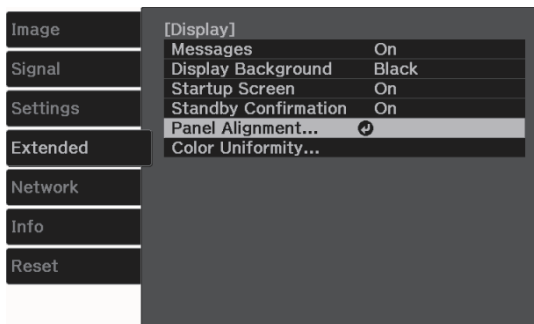

- 3 Enable **Panel Alignment**.

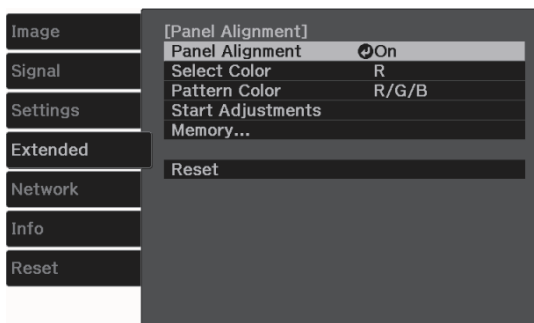

- (1) Select **Panel Alignment**, and then press the [Enter] button.
- (2) Select **On**, and then press the [Enter] button.
- (3) Press the [Esc] button to return to the previous screen.

- 4 Select the color you want to adjust.

- (1) Select **Select Color**, and then press the [Enter] button.
- (2) Select **R** (red) or **B** (blue), and then press the [Enter] button.
- (3) Press the [Esc] button to return to the previous screen.

- 5 Select the grid color displayed when making adjustments from **Pattern Color**.

- (1) Select **Pattern Color**, and then press the [Enter] button.
- (2) Select a combination of R (red), G (green), and B (blue) for the grid color.

R/G/B: Displays a combination all three colors; red, green and blue. The actual color of the grid is white.

R/G: This is available when **R** is selected from **Select Color**. Displays a combination of two colors; red and green. The actual color of the grid is yellow.

G/B: This is available when **B** is selected from **Select Color**. Displays a combination of two colors; green and blue. The actual color of the grid is cyan.

- (3) Press the [Esc] button to return to the previous screen.

6 Select **Start Adjustments**, and then press the [Enter] button.

First, select **Shift the whole panel** and adjust the entire LCD display. When a confirmation message is displayed, press the [Enter] button to start the adjustment.

 The image may become distorted while adjusting. The image is restored once adjustments are complete.

7 Use the up/down/left/right buttons to adjust, and then press the [Enter] button.

8 To make more detailed adjustments, select **Adjust the four corners**, and then press the [Enter] button to confirm the selection.

9 Use the up/down/left/right buttons to make adjustments, and then press the [Enter] button to move to the next adjustment point.

10 When you have adjusted all four corners, select **Exit**, and then press the [Enter] button.

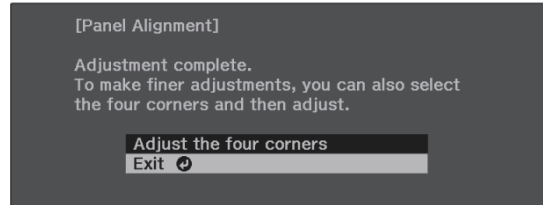

If you feel you still need to make adjustments after correcting all four points, select **Select intersection and adjust** and then continue making adjustments.

Color Uniformity

If colors in the projected image are uneven, you can adjust the color tone of the whole image in **Color Uniformity**.



The color tone may not be uniform even after performing color uniformity.

- 1 Press the [Menu] button while projecting, and then select **Display** from **Extended**.

Remote control

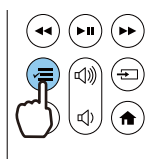

Control panel

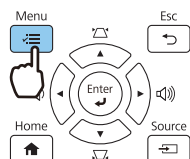

- 2 Select **Color Uniformity**, and then press the [Enter] button.

The following screen is displayed.

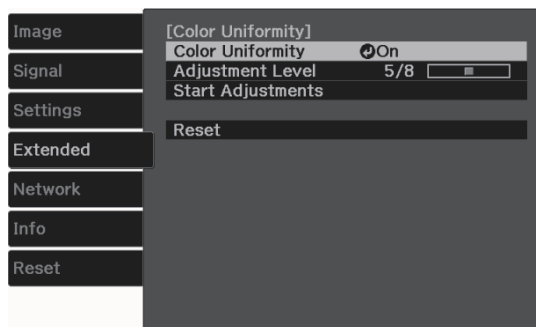

Color Uniformity: Turns color uniformity on or off.

Adjustment Level: There are eight levels from white, through gray, and up to black. You can adjust each level individually.

Start Adjustments: Starts making color uniformity adjustments.

Reset: Resets all adjustments and settings for **Color Uniformity** to their default values.



The image may become distorted while adjusting **Color Uniformity**. The image is restored once adjustments are complete.

- 3 Select **Color Uniformity**, and then press the [Enter] button.

- 4 Set this to **On**, and then press the [Esc] button.

- 5 Select **Adjustment Level**, and then press the [Enter] button.

- 6 Use the left and right buttons to set the adjustment level.

- 7 Press the [Esc] button to return to the previous screen.

- 8 Select **Start Adjustments**, and then press the [Enter] button.

- 9 Select the area you want to adjust, and then press the [Enter] button.

Adjust the outer areas first, and then adjust the whole screen.

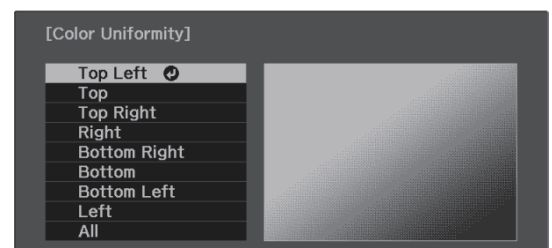

10 Use the up and down buttons to select the color you want to adjust, and then use the left and right buttons to adjust.

Press the left button to weaken the color tone. Press the right button to strengthen the color tone.



11 Return to step 5 and adjust each level.

12 To complete the adjustment, press the [Menu] button.



About PjLink

PjLink was established by the JBMIA (Japan Business Machine and Information System Industries Association) as a standard protocol for controlling network-compatible projectors as part of their efforts to standardize projector control protocols.

This projector complies with the PjLink Class2 standard established by the JBMIA.

The port number used by the search function of PjLink is 4352 (UDP).

You need to make network settings before you can use PjLink. See the following for more information on network settings.  [p.68](#)

It supports all commands defined by PjLink Class2 except for the following commands. The compliance is confirmed by the PjLink standard adaptability verification.

URL: <https://pjlink.jbmia.or.jp/english/>

- **Non-compatible commands**

Function		PjLink Command
Mute settings	Image muting set	AVMT 11
	Audio muting set	AVMT 21

- **Correspondence table for port name and source number**

Port name	Source number
HDMI1	32
HDMI2	33
HDMI3	36
LAN	52

- Manufacturer name displayed for "Manufacture name information query"

EPSON

- Model name displayed for "Product name information query"

EPSON LS500B/LS500W



Optional Accessories and Consumables

The following optional accessories and consumables are available for purchase if required. This list of optional accessories and consumables is current as of June 2019. Details of accessories are subject to change without notice.

Varies depending on country of purchase.

Optional Items

Name	Model No.	Explanation
Wireless LAN unit	ELPAP10	Use when connecting an external device to the projector via a wireless LAN to project images.

Consumables

Name	Model No.	Explanation
Air filter	ELPAF56	Use as a replacement for used air filters. (1 air filter)



Supported Resolutions

If the projector receives higher resolution signals than the resolution of the projector panel, the image quality may be degraded.

The projector supports signals marked with a check symbol.

PC

Signal Format	Resolution (Dots)		V Sync (Hz)	Dotclk (MHz)	HDMI								
					RGB		YCbCr						
							4:4:4		4:2:2		4:2:0		
					8	10, 12	8	10, 12	8	10, 12	8	10, 12	
VGA60	640	480	60	25.175	✓								

Unique Aspect

Signal Format	Resolution (Dots)		V Sync (Hz)	Dotclk (MHz)	HDMI								
					RGB		YCbCr						
							4:4:4		4:2:2		4:2:0		
					8	10, 12	8	10, 12	8	10, 12	8	10, 12	
21:9	2560	1080	60	198.000	✓								

SD

Signal Format	Resolution (Dots)		V Sync (Hz)	Dotclk (MHz)	HDMI							
					RGB		YCbCr					
							4:4:4		4:2:2		4:2:0	
					8	10, 12	8	10, 12	8	10, 12	8	10, 12
SDTV (480i)	720	480	59.94	13.500	✓	✓	✓	✓	✓	✓		
SDTV (576i)	720	576	50	13.500	✓	✓	✓	✓	✓	✓		
SDTV (480p)	720	480	59.94	27.000	✓	✓	✓	✓	✓	✓		
SDTV (576p)	720	576	50	27.000	✓	✓	✓	✓	✓	✓		

HD

Signal Format	Resolution (Dots)		V Sync (Hz)	Dotclk (MHz)	HDMI							
					RGB		YCbCr					
							4:4:4		4:2:2		4:2:0	
					8	10, 12	8	10, 12	8	10, 12	8	10, 12
HDTV (720p)	1280	720	50	74.250	✓	✓	✓	✓	✓	✓		
HDTV (720p)	1280	720	59.94	74.176	✓	✓	✓	✓	✓	✓		
HDTV (720p)	1280	720	60	74.250	✓	✓	✓	✓	✓	✓		
HDTV (1080i)	1920	1080	50	74.250	✓	✓	✓	✓	✓	✓		
HDTV (1080i)	1920	1080	59.94	74.176	✓	✓	✓	✓	✓	✓		
HDTV (1080i)	1920	1080	60	74.250	✓	✓	✓	✓	✓	✓		
HDTV (1080p)	1920	1080	23.98	74.176	✓	✓*	✓	✓*	✓	✓*		
HDTV (1080p)	1920	1080	24	74.250	✓	✓*	✓	✓*	✓	✓*		
HDTV (1080p)	1920	1080	29.97	74.176	✓	✓*	✓	✓*	✓	✓*		
HDTV (1080p)	1920	1080	30	74.250	✓	✓*	✓	✓*	✓	✓*		
HDTV (1080p)	1920	1080	50	148.500	✓	✓*	✓	✓*	✓	✓*		
HDTV (1080p)	1920	1080	59.94	148.352	✓	✓*	✓	✓*	✓	✓*		
HDTV (1080p)	1920	1080	60	148.500	✓	✓*	✓	✓*	✓	✓*		

* HDR is supported. (For HDR, HDR10 and HLG are supported.)

4K

Signal Format	Resolution (Dots)		V Sync (Hz)	Dotclk (MHz)	HDMI							
					RGB		YCbCr					
							4:4:4		4:2:2		4:2:0	
					8	10, 12	8	10, 12	8	10, 12	8	10, 12
4K (3840x2160)	3840	2160	23.98	296.703	✓	✓*	✓	✓*	✓	✓*		
4K (3840x2160)	3840	2160	24	297.000	✓	✓*	✓	✓*	✓	✓*		
4K (3840x2160)	3840	2160	25	297.000	✓	✓*	✓	✓*	✓	✓*		
4K (3840x2160)	3840	2160	29.97	296.703	✓	✓*	✓	✓*	✓	✓*		
4K (3840x2160)	3840	2160	30	297.000	✓	✓*	✓	✓*	✓	✓*		
4K (3840x2160)	3840	2160	50	297.000							✓	✓*
4K (3840x2160)	3840	2160	59.94	296.703							✓	✓*
4K (3840x2160)	3840	2160	60	297.000							✓	✓*

Signal Format	Resolution (Dots)		V Sync (Hz)	Dotclk (MHz)	HDMI							
					RGB		YCbCr					
							4:4:4		4:2:2		4:2:0	
					8	10, 12	8	10, 12	8	10, 12	8	10, 12
4K (3840x2160)	3840	2160	50	594.000	✓		✓		✓	✓ *		
4K (3840x2160)	3840	2160	59.94	593.407	✓		✓		✓	✓ *		
4K (3840x2160)	3840	2160	60	594.000	✓		✓		✓	✓ *		
4K(4096x2160) (SMPTE)	4096	2160	23.98	296.703	✓	✓ *	✓	✓ *	✓	✓ *		
4K(4096x2160) (SMPTE)	4096	2160	24	297.000	✓	✓ *	✓	✓ *	✓	✓ *		
4K(4096x2160) (SMPTE)	4096	2160	25	297.000	✓	✓ *	✓	✓ *	✓	✓ *		
4K(4096x2160) (SMPTE)	4096	2160	29.97	296.703	✓	✓ *	✓	✓ *	✓	✓ *		
4K(4096x2160) (SMPTE)	4096	2160	30	297.000	✓	✓ *	✓	✓ *	✓	✓ *		
4K(4096x2160) (SMPTE)	4096	2160	50	297.000							✓	✓ *
4K(4096x2160) (SMPTE)	4096	2160	59.94	296.703							✓	✓ *
4K(4096x2160) (SMPTE)	4096	2160	60	297.000							✓	✓ *
4K(4096x2160) (SMPTE)	4096	2160	50	594.000	✓		✓		✓	✓ *		
4K(4096x2160) (SMPTE)	4096	2160	59.94	593.407	✓		✓		✓	✓ *		
4K(4096x2160) (SMPTE)	4096	2160	60	594.000	✓		✓		✓	✓ *		

* HDR is supported. (For HDR, HDR10 and HLG are supported.)

3D

Signal Format	Resolution (Dots)		V Sync (Hz)	Dotclk (MHz)	3D Format	HDMI						
						RGB		YCbCr				
								4:4:4		4:2:2		
						8	10, 12	8	10, 12	8	10, 12	
HDTV (720p)	1280	720	60	148.500	Frame Packing	✓	✓	✓	✓	✓	✓	
					74.250	Side by Side	✓	✓	✓	✓	✓	✓
					74.250	Top and Bottom	✓	✓	✓	✓	✓	✓

Signal Format	Resolution (Dots)		V Sync (Hz)	Dotclk (MHz)	3D Format	HDMI						
						RGB		YCbCr				
								4:4:4		4:2:2		
						8	10, 12	8	10, 12	8	10, 12	
HDTV (720p)	1280	720	59.94	148.500	Frame Packing	✓	✓	✓	✓	✓	✓	
					74.250	Side by Side	✓	✓	✓	✓	✓	✓
					74.250	Top and Bottom	✓	✓	✓	✓	✓	✓
HDTV (720p)	1280	720	50	148.500	Frame Packing	✓	✓	✓	✓	✓	✓	
					74.250	Side by Side	✓	✓	✓	✓	✓	✓
					74.250	Top and Bottom	✓	✓	✓	✓	✓	✓
HDTV (1080i)	1920	1080	60	148.500	Frame Packing							
					74.250	Side by Side	✓	✓	✓	✓	✓	✓
					74.250	Top and Bottom						
HDTV (1080i)	1920	1080	59.94	148.500	Frame Packing							
					74.250	Side by Side	✓	✓	✓	✓	✓	✓
					74.250	Top and Bottom						
HDTV (1080i)	1920	1080	50	148.500	Frame Packing							
					74.250	Side by Side	✓	✓	✓	✓	✓	✓
					74.250	Top and Bottom						
HDTV (1080p)	1920	1080	24	148.500	Frame Packing	✓	✓	✓	✓	✓	✓	
					74.250	Side by Side	✓	✓	✓	✓	✓	✓
					74.250	Top and Bottom	✓	✓	✓	✓	✓	✓
HDTV (1080p)	1920	1080	23.98	148.500	Frame Packing	✓	✓	✓	✓	✓	✓	
					74.250	Side by Side	✓	✓	✓	✓	✓	✓
					74.250	Top and Bottom	✓	✓	✓	✓	✓	✓
HDTV (1080p)	1920	1080	60	297.000	Frame Packing							
				148.500	Side by Side	✓	✓	✓	✓	✓	✓	
				148.500	Top and Bottom							

Signal Format	Resolution (Dots)		V Sync (Hz)	Dotclk (MHz)	3D Format	HDMI						
						RGB		YCbCr				
								4:4:4		4:2:2		
						8	10, 12	8	10, 12	8	10, 12	
HDTV (1080p)	1920	1080	59.94	297.000	Frame Packing							
					148.500	Side by Side	✓	✓	✓	✓	✓	✓
					148.500	Top and Bottom						
HDTV (1080p)	1920	1080	50	297.000	Frame Packing							
					148.500	Side by Side	✓	✓	✓	✓	✓	✓
					148.500	Top and Bottom						



Specifications

EH-LS500W/EH-LS500B

Product name	EH-LS500W/EH-LS500B	
Appearance	458 (W) x 209.5 (H) x 375 (D) mm (not including adjustable foot)	
Panel Size	0.61"	
Display method	Polysilicon TFT active matrix	
Resolution	1920 (W) x 1080 (H) x 3	
Focus adjustment	Manual	
Zoom adjustment	1 - 1.35 (Digital)	
Light source	Laser diode	
Light source output	Max. 104.5 W	
Wavelength of light source	449 - 461 nm	
Light source life expectancy*1	Approx. 20,000 hours	
Power supply	100 - 240 V AC \pm 10%, 50/60 Hz, 3.8 - 1.7 A	
Power consumption	100 to 120 V area	When operating (when Light Output is 100%): 381 W When operating (when Light Output is 50%): 236 W
	220 to 240 V area	When operating (when Light Output is 100%): 366 W When operating (when Light Output is 50%): 230 W
Power consumption when standing by	Communication On: 2.0 W Communication Off: 0.5 W	
Operating altitude	Altitude 0 to 3048 m	
Operating temperature*2	+5 to +35°C (No condensation) (at an altitude of 0 to 2286 m)	
	+5 to +30°C (No condensation) (at an altitude of 2287 to 3048 m)	
Storage temperature	-10 to +60°C (No condensation)	
Mass	Approx. 9.5 kg	
Speaker	10 W x 2	

*1 Estimated time until the brightness of the light source is reduced by half.

(Assuming the projector is being used in an environment containing airborne particles of 0.04 to 0.2 mg/m³. This is an approximate guide only and may change depending on the projector's usage and surroundings.)

*2 When using the projector at an altitude of 1,500 m or more, set **High Altitude Mode** to **On** to make sure that the projector's internal temperature is adjusted correctly.  [p.65](#)

Connectors	HDMI port	3	HDMI HDCP2.2 supported, CEC signals supported, 3D signals supported, Linear PCM supported, Deep Color
	USB port*	1	USB connector (Type A) Supports USB 2.0
	DC Out (2.0A) power supply port*	1	USB connector (Type A)
	Audio Out port	1	Stereo mini jack (3.5Φ)
	RS-232C port	1	D-sub 9-pin (male)
	LAN port	1	RJ-45
	Service port*	1	USB connector (Type B) Supports USB 2.0

* Not guaranteed to operate all devices that support USB.

This product is also designed for IT power distribution system with phase-to-phase voltage 230V.

Supplier's DECLARATION of CONFORMITY

According to 47CFR, Part 2 and 15
Class B Personal Computers and Peripherals; and/or
CPU Boards and Power Supplies used with Class B Personal Computers

We: Epson America, Inc.
Located at: 3840 Kilroy Airport Way Long Beach, CA 90806
Tel: 562-981-3840

Declare under sole responsibility that the product identified herein, complies with 47CFR Part 2 and 15 of the FCC rules as a Class B digital device. Each product marketed, is identical to the representative unit tested and found to be compliant with the standards. Records maintained continue to reflect the equipment being produced can be expected to be within the variation accepted, due to quantity production and testing on a statistical basis as required by 47CFR 2.906. Operation is subject to the following two conditions : (1) this device may not cause harmful interference, and (2) this device must accept any interference received, including interference that may cause undesired operation.

Trade Name: EPSON
Type of Product: LCD Projector
Model: H922C
Options: Product Name: Remote controller
Model: 2198637xx (x=0-9)

**FCC Compliance Statement
For United States Users**

This device complies with part 15 of the FCC Rules. Operation is subject to the following two conditions: (1) This device may not cause harmful interference, and (2) this device must accept any interference received, including interference that may cause undesired operation.

This equipment has been tested and found to comply with the limits for a Class B digital device, pursuant to Part 15 of the FCC Rules. These limits are designed to provide reasonable protection against harmful interference in a residential installation. This equipment generates, uses, and can radiate radio frequency energy and, if not installed and used in accordance with the instructions, may cause harmful interference to radio communications.

However, there is no guarantee that interference will not occur in a particular installation. If this equipment does cause harmful interference to radio or television reception, which can be determined by turning the equipment off and on, the user is encouraged to try to correct the interference by one or more of the following measures.

- Reorient or relocate the receiving antenna.
- Increase the separation between the equipment and receiver.
- Connect the equipment into an outlet on a circuit different from that to which the receiver is connected.
- Consult the dealer or an experienced radio/TV technician for help.

WARNING

The connection of a non-shielded equipment interface cable to this equipment will invalidate the FCC Certification or Declaration of this device and may cause interference levels which exceed the limits established by the FCC for this equipment. It is the responsibility of the user to obtain and use a shielded equipment interface cable with this device. If this equipment has more than one interface connector, do not leave cables connected to unused interfaces. Changes or modifications not expressly approved by the manufacturer could void the user's authority to operate the equipment.



Appearance

Units: mm

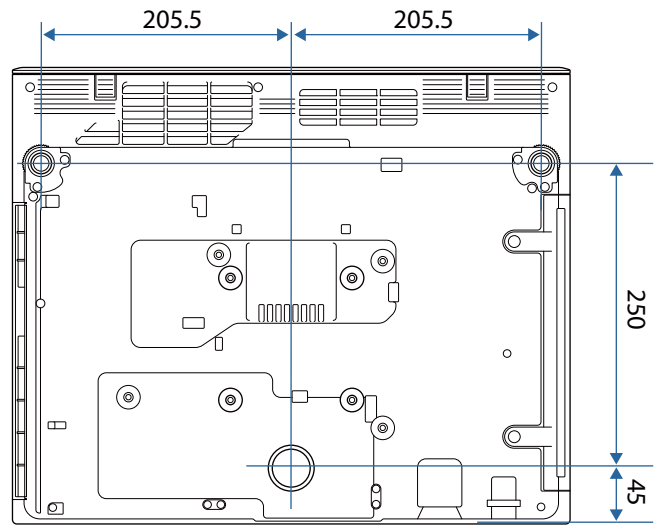
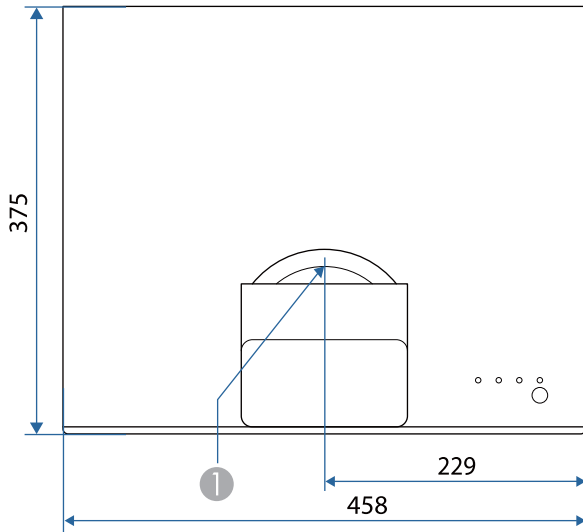



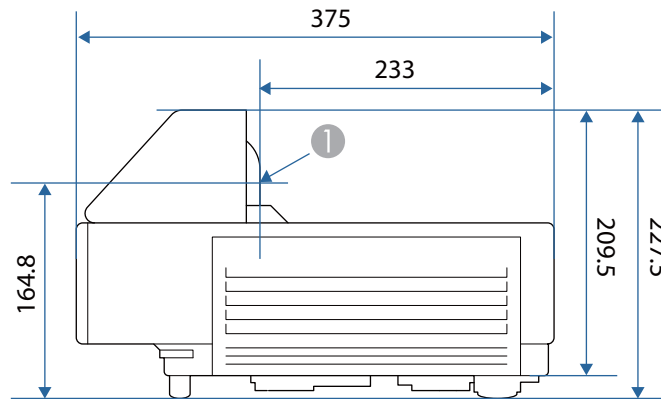

























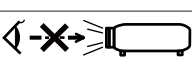

① Center of lens



List of Safety Symbols

The following table lists the meaning of the safety symbols labeled on the equipment.

Symbol mark	Approved standards	Meaning
	IEC60417 No. 5007	"ON" (power) To indicate connection to the mains.
	IEC60417 No. 5008	"OFF" (power) To indicate disconnection from the mains.
	IEC60417 No. 5009	Standby To identify the switch or switch position by means of which part of the equipment is switched on in order to bring it into the standby condition.
	ISO7000 No. 0434B IEC3864-B3.1	Caution To identify general caution when using the product.
	IEC60417 No. 5041	Caution, hot surface To indicate that the marked item can be hot and should not be touched without taking care.
	IEC60417 No. 6042 ISO3864-B3.6	Caution, risk of electric shock To identify equipment that has risk of electric shock.
	IEC60417 No. 5957	For indoor use only To identify electrical equipment designed primarily for indoor use.
	IEC60417 No. 5926	Polarity of d.c. power connector To identify the positive and negative connections (the polarity) on a piece of equipment to which a d.c. power supply may be connected.
	---	
	IEC60417 No. 5001B	Battery, general On battery powered equipment. To identify a device for instance a cover for the battery compartment, or the connector terminals.
	IEC60417 No. 5002	Positioning of cell To identify the battery holder itself and to identify the positioning of the cell(s) inside the battery holder.
	---	
	IEC60417 No. 5019	Protective earth To identify any terminal which is intended for connection to an external conductor for protection against electric shock in case of a fault, or the terminal of a protective earth electrode.
	IEC60417 No. 5017	Earth To identify an earth (ground) terminal in cases where neither the symbol  is explicitly required.

Symbol mark	Approved standards	Meaning
	IEC60417 No. 5032	Alternating current To indicate on the rating plate that the equipment is suitable for alternating current only; to identify relevant terminals.
	IEC60417 No. 5031	Direct current To indicate on the rating plate that the equipment is suitable for direct current only; to identify relevant terminals.
	IEC60417 No. 5172	Class II equipment To identify equipment meeting the safety requirements specified for Class II equipment according to IEC 61140.
	ISO 3864	General prohibition To identify actions or operations that are prohibited.
	ISO 3864	Contact prohibition To indicate injury that could occur due to touching a specific part of the equipment.
	---	Never look into the projection lens while the projector is on.
	---	To indicate that you must never place anything on the projector.
	ISO3864 IEC60825-1	Caution, laser radiation To indicate the equipment has a laser radiation part.
	ISO 3864	Disassembly prohibition To indicate a risk of injury, such as electric shock, if the equipment is disassembled.
	IEC60417 No. 5266	Standby, partial standby To indicate that part of the equipment is in the ready status.
	ISO3864 IEC60417 No. 5057	Caution, movable parts To indicate that you must keep away from movable parts according to protection standards.
	IEC 60417-6056	Caution (movable fan blades) To indicate that you must keep away from the blades of the movable fan according to protection standards.
	IEC 60417-6043	Caution (sharp corners) To indicate that you must not touch the sharp corners of the product according to protection standards.
	--	Never look into the projection lens while the projector is on.
	ISO7010 No. W027 ISO 3864	Warning, light emission (UV, visible light, IR and so on) To indicate that you must be careful not to injure your eyes or skin when near light emitting sections.
	IEC60417 No.5109	Not to be used in residential areas To indicate that the electrical equipment/device is not suitable for use in a residential area.



Safety Instructions for Laser Products

This projector is a Class 1 laser product that complies with IEC/EN60825-1: 2014. Make sure you follow the instructions below.



Warning

- Do not open the projector's case. The projector contains a high-powered laser product.
- Do not look directly into the projector's light source. The powerful light emitted could cause damage to eyesight.
- If a problem occurs with the projector, immediately turn off the power, unplug the power plug from the power outlet, and contact your local dealer or the contact information provided in the Epson Projector Contact List. Continuing to use the projector when a problem has occurred could not only cause fire or electric shock, but also damage to eyesight.

Attention

Do not disassemble the projector when disposing of it. Dispose of the projector in accordance with your country's regulations or local regulations.



- The projector's light source uses a laser. The laser has the following characteristics.
 - The brightness of the light source may be reduced according to the surroundings. The higher the temperature, the greater the reduction in brightness.
 - Light source calibration may be performed when the projector is turned off to correct the white balance of the light source and changes in the brightness level.

Laser Warning Labels

This projector comes with internal and external laser warning labels.

Internal



External

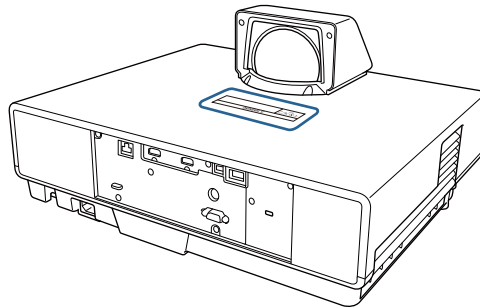

As with any bright source, do not stare into the beam, RG2 IEC/EN 62471-5:2015.



Glossary

This section briefly explains the difficult terms that are not explained in context in the text of this guide. For details, refer to other commercially available publications.

4K	This provides a high-quality image with a screen comprised of a 3840 x 2160 pixels.
Aspect Ratio	The ratio between an image's length and its height. Screens with a horizontal:vertical ratio of 16:9, such as HDTV screens, are known as wide screens. SDTV and general computer displays have an aspect ratio of 4:3.
HDCP	HDCP is an abbreviation for High-bandwidth Digital Content Protection. It is used to prevent illegal copying and protect copyrights by encrypting digital signals sent over DVI and HDMI ports. Because the HDMI port on this projector supports HDCP, it can project digital images protected by HDCP technology. However, the projector may not be able to project images protected with updated or revised versions of HDCP encryption.
HDMI™	An abbreviation for High Definition Multimedia Interface. This is the standard by which HD images and multichannel audio signals are digitally transmitted. HDMI™ is a standard aimed at digital consumer electronics and computers. By not compressing the digital signal, the image can be transferred at the highest quality possible. It also provides an encryption function for the digital signal.
HDTV	An abbreviation for High-Definition Television. This refers to high-definition systems which satisfy the following conditions. <ul style="list-style-type: none"> • Vertical resolution of 720p or 1080i or greater (p = Progressive, i = Interlace) • Screen aspect of 16:9 Dolby Digital audio reception and playback (or output)
Interlace	Transmits information needed to create one screen by sending every other line, starting from the top of the image and working down to the bottom. Images are more likely to flicker because one frame is displayed every other line.
Pairing	Register devices in advance when connecting with Bluetooth devices to ensure mutual communication.
SDTV	An abbreviation for Standard Definition Television. This refers to standard television systems which do not satisfy the conditions for HDTV High-Definition Television.
SVGA	A screen size standard with a resolution of 800 (horizontal) x 600 (vertical) dots.
SXGA	A screen size standard with a resolution of 1,280 (horizontal) x 1,024 (vertical) dots.
VGA	A screen size standard with a resolution of 640 (horizontal) x 480 (vertical) dots.
XGA	A screen size standard with a resolution of 1,024 (horizontal) x 768 (vertical) dots.
YCbCr	In component image signals for SDTV, Y is the brightness, while Cb and Cr indicate the color difference.
YPbPr	In component image signals for HDTV, Y is the brightness, while Pb and Pr indicate the color difference.



General Notes

All rights reserved. No part of this publication may be reproduced, stored in a retrieval system, or transmitted in any form or by any means, electronic, mechanical, photocopying, recording, or otherwise, without the prior written permission of Seiko Epson Corporation. No patent liability is assumed with respect to the use of the information contained herein. Neither is any liability assumed for damages resulting from the use of the information contained herein.

Neither Seiko Epson Corporation nor its affiliates shall be liable to the purchaser of this product or third parties for damages, losses, costs, or expenses incurred by the purchaser or third parties as a result of: accident, misuse, or abuse of this product or unauthorized modifications, repairs, or alterations to this product, or (excluding the U.S.) failure to strictly comply with Seiko Epson Corporation's operating and maintenance instructions.

Seiko Epson Corporation shall not be liable against any damages or problems arising from the use of any options or any consumable products other than those designated as Original Epson Products or Epson Approved Products by Seiko Epson Corporation.

The contents of this guide may be changed or updated without further notice.

Illustrations in this guide and the actual projector may differ.

Restriction of Use

When this product is used for applications requiring high reliability/safety such as transportation devices related to aviation, rail, marine, automotive etc.; disaster prevention devices; various safety devices etc; or functional/precision devices etc, you should use this product only after giving consideration to including fail-safes and redundancies into your design to maintain safety and total system reliability. Because this product was not intended for use in applications requiring extremely high reliability/safety such as aerospace equipment, main communication equipment, nuclear power control equipment, or medical equipment related to direct medical care etc, please make your own judgment on this product's suitability after a full evaluation.

Indication of the manufacturer and the importer in accordance with requirements of directive 2011/65/EU (RoHS)

Manufacturer: SEIKO EPSON CORPORATION

Address: 3-5, Owa 3-chome, Suwa-shi, Nagano-ken 392-8502 Japan

<http://www.epson.com/>

Importer: EPSON EUROPE B.V.

Address: Atlas Arena, Asia Building, Hoogoorddreef 5, 1101 BA Amsterdam
Zuidoost The Netherlands

<http://www.epson.eu/>

General Notice

"EPSON" is a registered trademark of Seiko Epson Corporation. "EXCEED YOUR VISION" is a registered trademark or trademark of the Seiko Epson Corporation.

iPad, iPhone, Mac ,OS X, and iOS are trademarks of Apple Inc.

Windows and the Windows logo are trademarks or registered trademarks of the Microsoft Corporation in the United States and/or other countries.

HDMI, the HDMI Logo and High-Definition Multimedia Interface are trademarks or registered trademarks of HDMI Licensing Administrator, Inc. 

The Bluetooth® word mark and logo are registered trademarks of Bluetooth SIG, Inc., and the Seiko Epson Corporation uses these marks under license. Other trademarks or trade names are the property of their respective owners.

Bluetopia® is provided for your use by Stonestreet One, LLC® under a software license agreement. Stonestreet One, LLC® is and shall remain the sole owner of all right, title and interest whatsoever in and to Bluetopia® and your use is subject to such ownership and to the license agreement. Stonestreet One, LLC® reserves all rights related to Bluetopia® not expressly granted under the license agreement and no other rights or licenses are granted either directly or by implication, estoppel or otherwise, or under any patents, copyrights, mask works, trade secrets or other intellectual property rights of Stonestreet One, LLC®.

© 2000-2012 Stonestreet One, LLC® All Rights Reserved.

WPA™ and WPA2™ are registered trademarks of the Wi-Fi Alliance.

App Store is a service mark of Apple Inc.

Google, Android TV, YouTube and Google Play are trademarks of Google LLC.

"QR Code" is a registered trademark of DENSO WAVE INCORPORATED.

Other product names used herein are also for identification purposes only and may be trademarks of their respective owners. Epson disclaims any and all rights in those marks.

©SEIKO EPSON CORPORATION 2021. All rights reserved.



- 3**
- 3D brightness 62
 - 3D display 62
 - 3D format 62
 - 3D Glasses 46
 - 3D images 45
 - 3D setup 62
- 4**
- 4K Enhancement 61
- A**
- A/V mute 32
 - Adjusting focus 28
 - Adjusting RGB 39
 - Adjusting the position of the image 29
 - Advanced 61, 63
 - Air exhaust vent 8, 10
 - Air filter 86, 88
 - Air filter cover 7
 - Air intake vent 7, 10
 - AMX device discovery 71
 - Appearance 104
 - Aspect 33, 62
- B**
- Basic menu 69
 - Blanking 63
 - Brightness 40, 60, 61
- C**
- Channel 70
 - Child lock 64
 - Cleaning the lens 88
 - Cleaning the main unit 88
 - Color depth 72
 - Color format 72
 - Color Mode 33
 - Color mode 60
 - Color saturation 60
 - Color Space 62
 - Color temp. 39, 60
 - Color Uniformity 92
 - Color uniformity 66
 - Configuration menu 59
 - Connecting 18
 - Connecting a computer 20
 - Connecting an ARC compatible AV system 22
 - Connecting external speakers 21
 - Connecting media streaming devices ... 18
- Connecting to the LAN port 20
 - Connecting video equipment 20
 - Connection mode 70
 - Contrast 60
 - Control panel 7, 11
 - Control panel lock 64
 - Control4 SDDP 71
 - Cool-down 27
- D**
- Deinterlacing 61
 - Detail Enhancement 61
 - Detail enhancement 36
 - DHCP 70, 71
 - Direct power on 67
 - Display 66
 - Display background 66
 - Display LAN info. 69
 - Display the QR code 69
 - Dynamic contrast 37, 61
 - Dynamic range 62
- E**
- EDID 63
 - Event ID 85
 - Extended menu 65
- F**
- Focus 78
 - Focus adjustment 28
 - Focus lever 7
 - Focus ring 28
 - Frame interpolation 37, 61
 - Front adjustable foot 10
 - Front cover 7
 - Full 33
- G**
- Gain 39, 60
 - Gamma 41, 61
 - Gateway Address 71
 - Gateway address 70
 - G-M Correction 60
 - Grayscale 60
- H**
- H/V-Keystone 30
 - HDMI Link 48
 - HDMI link 64
 - High altitude mode 67
 - Home screen 26, 65

- Hue 40, 61
- I**
- Illumination 67
- Image 33
- Image enhancement 36, 61
- Image menu 60
- Image processing 38, 63
- Image Shift 63
- Image shift 29
- Indicators 7, 73
- Info menu 72
- Inverse 3D glasses 62
- IP Address 71
- IP address 70
- IP Address Display 71
- IP address display 70
- IP settings 70
- K**
- Keystone 63
- Keystone distortion 30, 63
- L**
- Language 67
- Lens 8
- Light output 61
- Light source info 72
- Lock setting 64
- M**
- Memory 65
- Memory function 43
- Menu 59
- Messages 66
- MPEG Noise Reduction 61
- MPEG noise reduction 36
- Mute 32
- N**
- Network menu 68
- Noise 78
- Noise Reduction 61
- Noise reduction 36
- O**
- Offset 39, 60
- Operating range 23
- Operation 67
- Others menu 71
- Overscan 62
- P**
- Panel Alignment 90
- Panel alignment 66, 68
- Passphrase 70
- PJLink 94
- Power 27
- Power supply 8, 24
- Projection 66
- Projection distance 17
- Projection size 28
- Projector info 72
- Projector name 69
- Q**
- Quick Corner 31, 63
- R**
- Rear foot 10
- Remote control 12, 23
- Remote password 69
- Replacing consumables 88
- Reset 61, 63, 65, 67
- Reset all config 72
- Reset memory 72
- Reset menu 72
- RGBCMY 40, 61
- S**
- Saturation 40, 61
- Screen size 17
- Search access point 70
- Security 55, 70
- Security menu 70
- Settings menu 63
- Sharpness 35, 60
- Signal menu 62
- Sleep mode 67
- Soft keyboard 69
- Source 25
- Speaker 7
- Specifications 101
- SSID 70
- SSID display 70
- Standby button 7
- Standby mode 67
- Startup screen 66
- Storage space cover 7
- Subnet Mask 71
- Subnet mask 70
- Super-resolution 36, 61
- Supported resolutions 96

T

Tint 60

U

USB power in standby 67

V

Version 72

Volume 32, 63

W

White balance 60

Wired LAN menu 71

Wireless LAN menu 70

Wireless LAN power 68

Wireless LAN unit 21

Z

Zoom 28, 33, 63