

**EPSON®**

**ELPDC30**

# **Document Camera User's Guide**

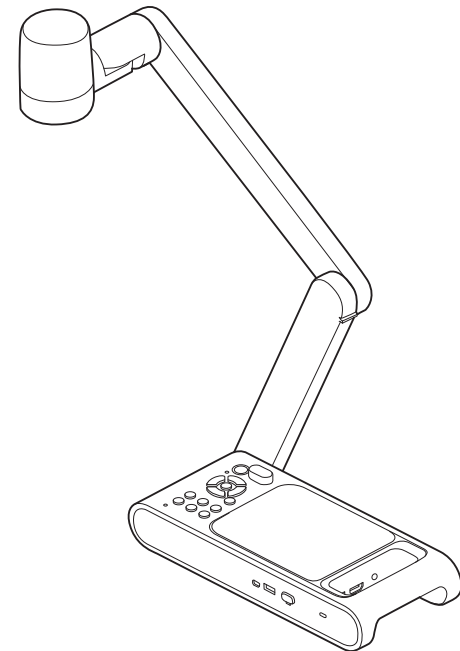



# Meaning of Symbols in the Guide



- **Symbols for Safety**

The documentation and this product use graphical symbols to show how to use this product safely.

The indications and their meaning are as follows. Make sure you understand and respect these caution symbols to avoid injury to persons or property.

 <b>Warning</b>	This symbol indicates information that, if ignored, could possibly result in personal injury or even death due to incorrect handling.
 <b>Caution</b>	This symbol indicates information that, if ignored, could possibly result in personal injury or physical damage due to incorrect handling.

- **Symbols for General Information**

<b>Attention</b>	Indicates information that, if ignored, could cause the product to malfunction or cause damage.
	Indicates additional information and points which may be useful to know regarding a topic.
	Indicates a page where detailed information regarding a topic can be found.
[Name]	Indicates button names for the remote control or the control panel. Example: [AF] button, [Enter] button
Menu Name	Indicates the on-screen menu item. Example: Select <b>Brightness</b> from the <b>Image</b> menu. <b>Image - Brightness</b>

# Safety Instructions

Read this *User's Guide* and follow all safety instructions for your document camera. Keep this guide at hand for future reference.

## Environmental Precautions

### **Warning**

Do not use or store the document camera or remote control in a hot location, such as near a heater, in direct sunlight, or in a closed vehicle. Thermal damage, fire, or malfunction may occur.

Do not use or store the document camera outdoors for an extended length of time, or where it may be exposed to rain, water, or excessive humidity. Doing so may result in fire or electric shock.

Do not use or store the document camera where it may be exposed to smoke, steam, corrosive gases, or excessive dust. Fire or electric shock may result.

Do not use or store in locations subject to dust or trash. Doing so may cause the quality of the image to decline, or cause a malfunction or fire to occur.

This equipment is not suitable for use in locations where children are likely to be present.

### **Caution**

Do not set up the document camera near high-voltage electrical wires or sources of magnetic fields. This may interfere with correct operation.

Never open the equipment. For safety reasons, the equipment should be opened by qualified skilled person.

Operate in the proper environmental conditions. ➡ "General Specifications" [p.55](#)

Do not place or store the document camera where it is accessible to small children. It may drop or tip over, causing personal injury.

Do not place the document camera where it may be exposed to vibration or shock.

Do not use or store in locations subject to high or low temperatures. Also, avoid locations subject to sudden changes in temperature. Sudden changes in temperature may cause a malfunction to occur.

Remove the batteries from the remote control when storing it.

If the batteries are left in for a long time, liquid may leak from the batteries or other problems may occur.

## Electrical Precautions

### **Warning**

Never open any covers on the document camera except as specifically explained in this *User's Guide*. Never attempt to disassemble or modify the document camera. Refer all repairs to qualified service technicians. Electrical voltages inside the product can cause fire, electrical shock, or severe injury to occur.

Unplug the AC adapter and power plug from the outlet and refer all repairs to qualified service personnel under the following conditions:

- If smoke, strange odors, or strange noises come from the device
- If liquid or foreign objects get inside the device
- If the device has been dropped or the housing has been damaged

If you continue using the product as it is, it could cause an electric shock, fire, or even damage to eyesight.

Do not try to repair this product yourself.

Place the product near an easily accessible outlet so that the plug can be unplugged immediately when an error occurs.

Do not use a power source with a voltage other than those specified in the *User's Guide*. Use of a different power source may result in fire or electric shock. If you are not sure of the power available, consult your dealer or power company.

Do not attempt to use any adapter other than the AC adapter and power cord included with the device. Using an improper adapter may cause damage, overheating, fire, or electric shock.

Be sure to use the AC adapter with the proper voltage indicated in this guide. Use of a different power source may result in fire or electric shock.

Do not pull on the AC adapter cable or place heavy objects on the cable. Doing so may result in fire or electric shock.

Do not subject the AC adapter to excessive force or impacts, such as stepping on it, dropping it, or striking it. Doing so may result in damage that may cause a fire or electric shock to occur.

If the AC adapter, power cable, or the product itself is damaged, turn off the power, unplug the cables, and contact your local dealer or Epson Service Call Center. Using the damaged device may cause fire or electric shock.

Do not spill tea, coffee, juice, or other beverages on the AC adapter or spray it with insecticide. Liquids entering the document camera may cause malfunction, fire, or electric shock.

If water or other liquids are spilled on the device, turn off the power, unplug the AC adapter from the outlet, and contact your local dealer. Continuing to use the device in this condition may cause a fire or electric shock to occur.

Do not place the AC adapter in a confined space or cover it with a cloth. Doing so could cause the AC adapter to become hot which may cause burns or an unexpected accident to occur.

Wrapping the power cable around the AC adapter may cause it to disconnect or cause abnormal heat generation. Do not use the device in this condition.

If the AC adapter, power cord, or document camera is damaged, turn the power off, unplug the AC adapter from the electrical outlet, and contact your local dealer or Epson for help.

Do not touch the device, the AC adapter, or the plug with wet hands. Otherwise, you may receive an electric shock.

## **Warning**

Check the specifications of the power cord. Using an inappropriate power cord could result in fire or electric shock.

Do not use a power cord that is damaged. Doing so may result in fire or electric shock. Take the following precautions when handling the power cord:

This product is intended to be supplied by a UL listed (Certificate) power supply comply with LPS or PS2, output rated 5Vdc, 3A minimum, Tma 35 degree C minimum and altitude 2286m, if need further assistance, please contact manufacture or UL File owner or brand owner further information.

The equipment power supply cord shall be connected to a socket-outlet with earthing connection.

- Do not modify the power cord.
- Do not place heavy objects on the power cord.
- Do not bend, twist or pull the power cord excessively.
- Keep the power cord away from hot electrical appliances.
- Do not tie the power cord to other cables.

If the power cord becomes damaged (the core wire is exposed, the wire is broken wire, and so on), contact your dealer.

Take the following precautions when handling the plug. Failure to comply with these precautions could result in fire or electric shock.

- Do not modify the power plug.
- Do not overload wall outlets, extension cables, or power strips.
- Do not insert the plug into a dusty outlet.
- Insert the plug firmly into the outlet.
- Do not hold the plug with wet hands.
- Do not pull the power cord when disconnecting the plug; always be sure to hold the plug when disconnecting it.
- Use only the specified power supply (AC adapter).

Do not touch the plug during an electrical storm. Otherwise, you may receive an electric shock.

Be sure to ground the power plug with a grounding wire or a 3-core power plug. Otherwise, it could result in fire or electric shock.

Use the supplied power cord and ground it on the outlet side.

For power plugs with a grounding wire, be sure to connect this wire before plugging in the power plug. Also, when disconnecting the ground wire, be sure to first disconnect the power plug from the outlet.

For 3-core power plugs, be sure to plug in to an outlet that provides 3-core grounding.



## Caution

Turn off the document camera and unplug it after use. The insulation may deteriorate, which may result in fire.

Make sure the power is turned off, the plug is disconnected from the outlet, and all cables are disconnected before moving the document camera. Fire or electric shock may result.

## Installation Precautions



## Caution

Do not place the document camera in an unstable location, such as on a shaky table or slanted surface. The document camera may drop or tip over, causing personal injury. If you use a table, cart, or stand, make sure it is stable and will not fall over.

When using the mounting points under the document camera to secure it to a table, cart, or stand, fasten the two bolts securely but do not overtighten them. Do not use adhesives.

Do not place the product in the following locations.

- Badly ventilated or narrow places, such as inside a closet or in a book case.
- On soft surfaces such as a rug, bedding, blanket, and so on.
- Do not cover the product with a blanket, curtain, or tablecloth.
- Badly ventilated locations such as inside an AV rack or cabinet.
- Locations subject to high temperatures, such as near heating equipment.

Route cables so that they are not a tripping hazard. Otherwise, they could trip someone and cause a fall or injury.

Do not stand on the product or place heavy objects on it. You may fall over resulting in injury or the product may become damaged.

## Cleaning Precautions

### **Warning**

Do not place any containers of liquid on top of or near the document camera. Spilling liquid of any kind into the product may result in fire or electric shock.

Do not spill liquid or spray fine mist into the document camera. Liquids entering the document camera may cause malfunction, fire, or electric shock. If you spilled liquid, turn the power off, unplug the AC adapter from the electrical outlet, and contact your local distributor. Using the damaged device may cause fire or electric shock.

Never allow objects of any kind to enter any openings in the document camera. Do not leave objects, especially flammable objects, near the document camera. Doing so may result in fire or electric shock.

### **Caution**

Use a dry cloth (or, for stubborn stains, a moist cloth that has been wrung dry) for cleaning. Do not use liquid, aerosol cleaners, or solvents such as alcohol, thinner or benzene. Water infiltration or deterioration and breakage of the product housing could result in electric shock.

Be sure that the AC adapter, power plug, and power connector are unplugged from their power outlets, and that all wires are disconnected before cleaning the product. This avoids electric shock during cleaning.

## Usage Precautions

### **Warning**

Do not look into the camera head or LED lamp section after turning on the power. The bright light can damage your eyes. Be especially careful in households with small children. Also, do not look into the lens through an optical instrument such as a magnifying glass or telescope.

Be sure that no one is looking into the camera head or LED lamp when using the remote control to turn on the product from a distance.

Do not allow small children to use this device. If there is a possibility that a child may use this device, they must be supervised by a parent or guardian.

## Battery Precautions



### Caution

Incorrect battery usage may cause leakage of battery fluid and battery rupture, which could result in fire, injury or corrosion of the product.

When replacing batteries, take the following precautions.

- Do not use batteries of different types or mix old and new batteries.
- Do not use any batteries other than those specified in the *User's Guide*.
- If the batteries leak, wipe away battery fluid with a cloth and so on, and replace them with new batteries. If fluid gets on your hands, wash them immediately.
- Replace the batteries as soon as they run out.
- Remove the batteries if you will not be using the product for a long period of time.
- Do not expose batteries to heat or flame and do not put them in water.
- Insert batteries so that the polarities (+ and -) are correct.

If battery fluid gets in your eyes, do not rub your eyes. Wash them well with clean water and contact a doctor immediately.

If battery fluid enters your mouth, rinse immediately with plenty of water and contact a doctor immediately.

If battery fluid comes in contact with your skin or clothes, wash with water to prevent possible skin damage.

Keep batteries out of the reach of children. Batteries are a choking hazard and are very dangerous if swallowed. If a battery is swallowed, seek medical attention immediately.

Do not use any batteries other than those specified in the *User's Guide*.

Insert batteries so that the polarities (+ and -) are correct. Not doing so may cause leakage, overheating, or explosion.

Be sure to replace both batteries with new ones of the same type. Not doing so may cause leakage, overheating, or explosion.

Remove the batteries if you will not be using the remote control for a long period of time. When a battery runs down, take it out of the remote control immediately.

If a used-up battery is left inside for a long time, gas emitted from the battery may cause leakage, overheating, explosion, or damage to the remote control.

Do not expose batteries to heat, flame, or water.

Dispose of used batteries according to local regulations.



**Meaning of Symbols in the Guide ..... 2**

**Safety Instructions ..... 3**

## Introduction

---

**Included Items ..... 12**

**Document Camera Parts ..... 13**

- Top/Side/Rear ..... 13
- Control Panel ..... 14
  - Shortcut key ..... 15
- Base ..... 16

**Remote Control Buttons ..... 17**

- Remote Control ..... 17

**LED Indicators ..... 19**

## Connecting

---

**Connecting the Document Camera to a Projector ..... 21**

- Connecting Using the HDMI Cable ..... 21
- Connecting to a Projector via Miracast ..... 22
  - When Using a Computer ..... 23

**Connecting to a Projector using Software ..... 24**

- Using Easy Interactive Tools ..... 24
- Using Epson Connect Tool for Document Camera ..... 25

## Projecting

---

**Positioning the Document Camera ..... 27**

**Plugging In and Turning On ..... 28**

**Projecting ..... 29**

- Switching the Projected Image ..... 30
- Freezing an Image ..... 30
- Projecting Small Objects ..... 30
- Displaying Whiteboard Images ..... 31
- Projecting Through a Microscope ..... 32

**Turning Off ..... 34**

## Saving Images and Playing a Slideshow or Video

---

**Saving Images ..... 36**

**Saving Videos ..... 37**

**Playing a Slideshow (displaying thumbnail screen) ..... 38**

**Displaying Saved Images or Playing Videos ..... 39**

## Image Adjustments and Effects

---

**Using the On-screen Menu ..... 41**

**On-Screen Menu Table ..... 42**

- Image ..... 42
- Miracast ..... 43
- System ..... 43
- Playback Mode ..... 45

## Solving Problems

---

<b>Problems and Solutions</b> .....	<b>47</b>
Operation Problems .....	47
Image Quality Problems .....	47
Problems related to USB Flash Drive .....	48
Miracast Problems .....	48
Remote Control Problems .....	48
<b>Epson Projector Contact List</b> .....	<b>49</b>
EUROPE .....	49
AFRICA .....	52
MIDDLE EAST .....	52
NORTH, CENTRAL AMERICA & CARIBBEAN ISLANDS .....	52
SOUTH AMERICA .....	52
ASIA AND OCEANIA (Country/Region) .....	53

## Appendix

---

<b>Specifications</b> .....	<b>55</b>
General Specifications .....	55
List of Supported Resolutions .....	57
Zoom Magnification and Projection Distance by Image Mode .....	58
<b>Optional Items</b> .....	<b>59</b>
<b>Safety Standard Compliance Symbols and Descriptions</b> .....	<b>60</b>
<b>Notice</b> .....	<b>62</b>
FCC Compliance Statement .....	62
<b>Copyrights and Trademarks</b> .....	<b>64</b>
Trademarks .....	64

# Introduction

You can use this document camera to capture and project pages from books or other documents, and even three-dimensional objects. By using the software Easy Interactive Tools supplied, you can operate the document camera from a computer, and by using Epson Connect Tool for Document Camera, you can connect the document camera to a projector via Miracast.

- Remote control with 2 AA batteries
- Power cord and adapter
- HDMI cable
- USB cable
- Quick Start Guide
- Microscope adapter

## Top/Side/Rear

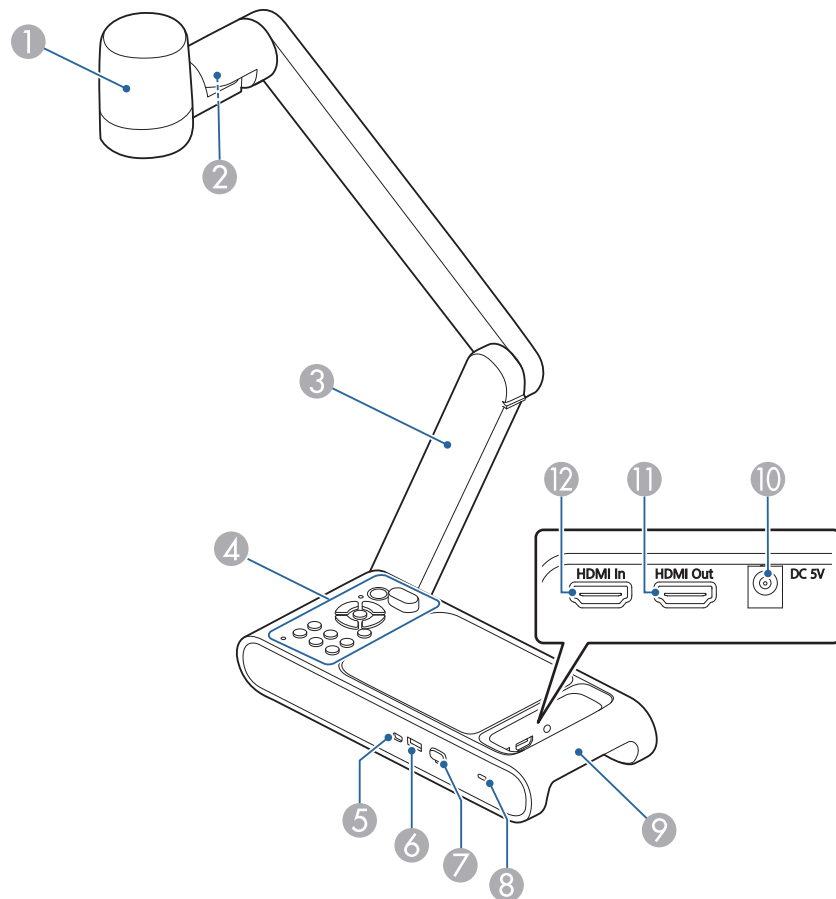

Name	Function
① Camera head	The lens built in here captures a subject and the image is projected onto the connected device.
② LED lamp	Provides additional light when there is not enough light on your document.
③ Camera arm	Extends or retracts to adjust the height of the camera head.

Name	Function
④ Control panel	☛ "Control Panel" p.14
⑤ USB Mini-B port	Inputs image signals to a computer connected with a USB cable.
⑥ USB-A port	Outputs images to image devices such as projectors.
⑦ Wi-Fi dongle	A wireless LAN unit is connected.
⑧ Security slot	The security slot is compatible with the Microsaver security system manufactured by Kensington.
⑨ Handle, and Security cable installation point	Hold this handle when moving the document camera. You can also attach a security cable here to prevent the document camera from being stolen.
⑩ Power (DC 5V) port	Connects the supplied AC power adapter.
⑪ HDMI output port	Outputs images and audio to a video device that is compatible with HDMI signals.
⑫ HDMI input port	Inputs signals from a video device or computer that is compatible with HDMI signals.

### Attention

Do not rub the lens with harsh materials or subject it to shock, as it can be easily damaged. Use a soft cloth to gently wipe the lens.

## Control Panel

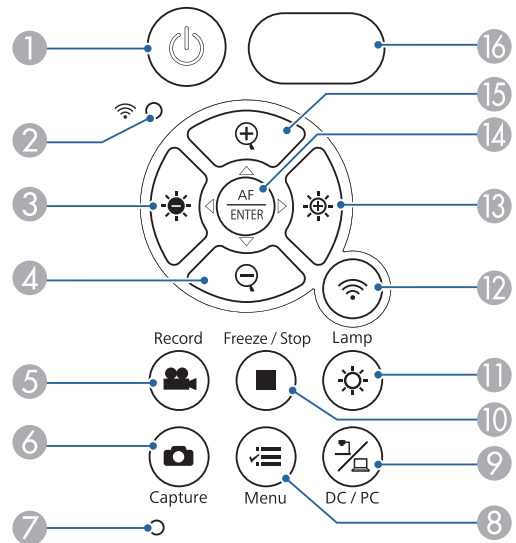

Name	Function
1 [⏻] power button	Turns the document camera on or off.
2 Wi-Fi indicator	Indicates Wi-Fi connection status. 🔌 "LED Indicators" p.19
3 [☀️] button	Darkens the projected image while projecting images from the document camera. Lets you return to the previous image during a slideshow, or lets you rewind during playback of a video.
4 [☹️] button	Reduces the image without changing the projection size.
5 [Record] button [🎥]	Starts and stops video recording.
6 [Capture] button [📷]	Captures still images. Lets you delete an image or video selected in a file list screen.

Name	Function
7 Microphone	Captures sound when you record a video.
8 [Menu] button [☰]	Opens and closes the menu.
9 [DC/PC] button [🖥️]	Lets you switch projected images between live images from the document camera and images from a connected computer. Press this during a slideshow or playback of a video to return to the camera mode.
10 [Freeze/Stop] button [⏸️]	Freezes live images. Press the button again to resume projection. While playing a video, stops the video.
11 [Lamp] button [💡]	Turns the LED on the camera on or off.
12 [Wi-Fi] button [📶]	Lets you switch between the Wi-Fi mode and the USB mode.
13 [☀️] button	Brightens the projected image while projecting images from the document camera. Lets you advance to the next image during a slideshow, or lets you fast-forward during playback of a video.
14 [AF/ENTER] button [AF/ENTER]	Focuses on a subject automatically, or when displaying the menus, selects a highlighted menu.
15 [➕] button	Enlarges the image without changing the projection size.
16 Remote control signal receiving part	Receives signals from the remote control.

**Shortcut key**

Some functions can be selected by pressing two buttons simultaneously.

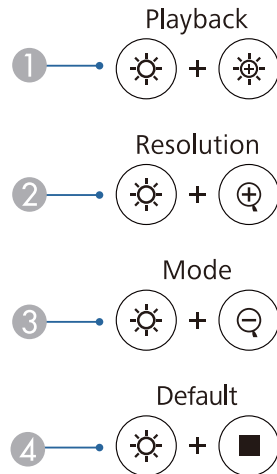

Name	Explanation
1 Playback	Starts or stops playback of a video.
2 Resolution	Lets you switch between the multiple resolution settings. Each press of the buttons switches the resolution in the order shown below. <b>3840x2160 @ 60</b> <b>3840x2160 @ 30</b> <b>1920x1080</b> <b>1280x720</b> <b>1024x768</b>

Name	Explanation
3 Mode	Lets you switch between the multiple image modes. Each press of the buttons switches the mode in the order shown below. <b>Normal</b> <b>Motion</b> <b>Wide Angle</b> <b>Microscope</b> <b>Macro</b> <b>Infinity</b>
4 Default	Resets the document camera to factory default settings.

**Base**

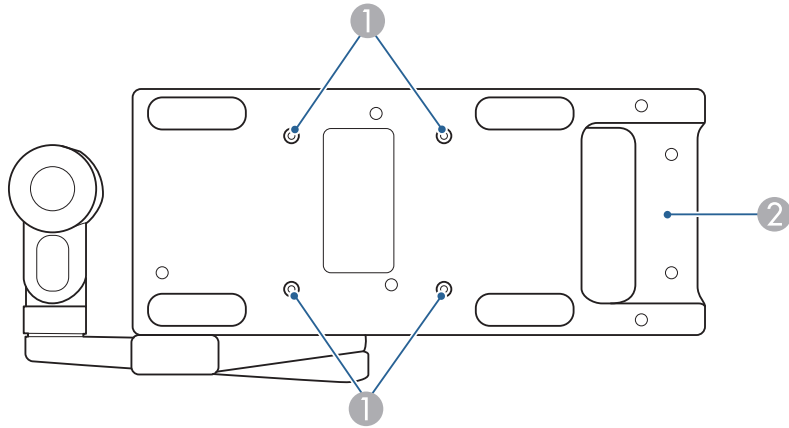





	Name	Function
1	Mounting points	<p>You can attach the document camera to a table, cart, or stand with commercially available M4 bolts. You can thread them to a maximum depth of 5mm (0.35 inch).</p> <div style="border: 1px solid black; padding: 5px; margin-top: 10px;"> <p><b>Attention</b></p> <p>Fasten the bolts securely but do not overtighten them. Do not use adhesives.</p> </div>
2	Handle, and Security cable installation point	<p>Hold this handle when moving the document camera. You can also attach a security cable here to prevent the document camera from being stolen.</p>

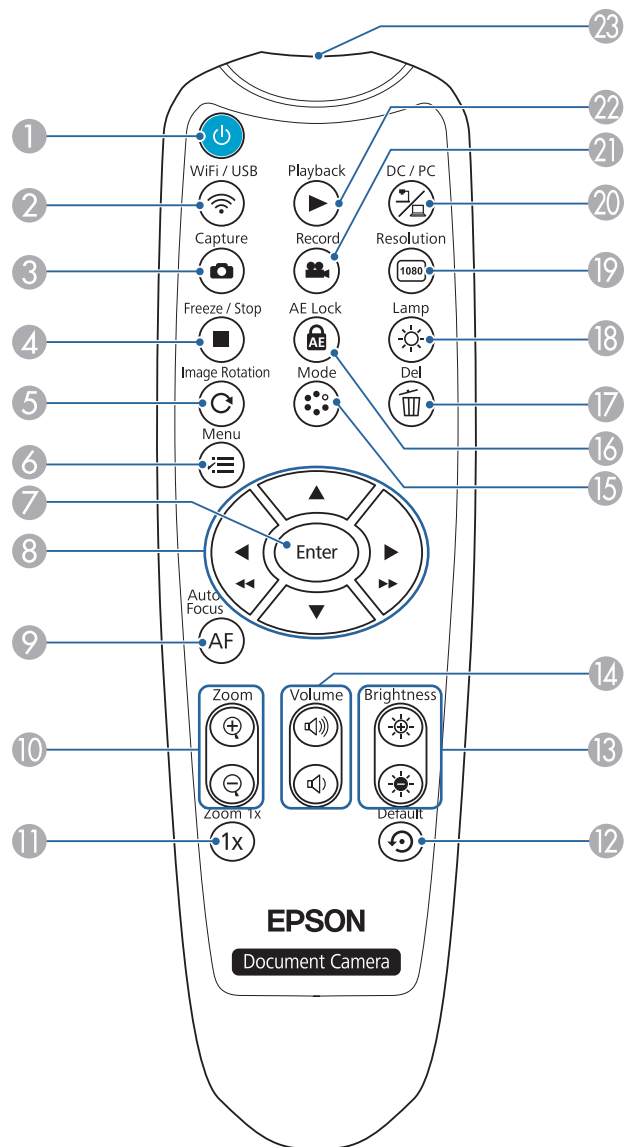



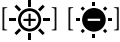
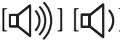

## Remote Control



Name	Function
1 [Power] button	Turns the document camera on or off.
2 [WiFi/USB] button [WiFi]	Lets you switch between the Wi-Fi mode and the USB mode.
3 [Capture] button [Camera]	Captures still images.
4 [Freeze/Stop] button [Black Square]	Freezes live images. Press the button again to resume projection. While playing a video, stops the video.
5 [Rotate Image] button [Circular Arrow]	Lets you turn an image upside-down.
6 [Menu] button [List Icon]	Opens and closes the menu.
7 [Enter] button	When the menu is displayed, pressing this button confirms the current item. During a slideshow, lets you reload a still image. During video playback, pauses and resumes playback.
8 [Up] [Down] [Left/Right] buttons [Left/Right]	When the menu screen is displayed, pressing these buttons selects menu items and setting values. During a slideshow, press [Left/Right] to return to the previous image, or press [Right/Right] to advance to the next image. During video playback, press [Left/Left] to rewind, or press [Right/Right] to fast-forward.
9 [Auto Focus] button [AF]	Focuses on a subject automatically.
10 [Zoom] button [+/-]	Enlarges or reduces the image without changing the projection size when projecting document camera's live images or captured still images.
11 [Zoom 1x] button [1x]	Resets the zoom level to 1x.

	Name	Function
12	[Default] button 	Resets the document camera to factory default settings.
13	[Brightness] button 	Adjusts the projected image brightness.
14	[Volume] button 	Adjusts the volume.
15	[Mode] button 	Lets you switch between the multiple image modes. Each press of the buttons switches the mode in the order shown below. <b>Normal</b> <b>Motion</b> <b>Wide Angle</b> <b>Microscope</b> <b>Macro</b> <b>Infinity</b>
16	[AE Lock] button 	Stops automatic exposure adjustment and fixes exposure level.
17	[Del] button 	Deletes an image or video in the playback mode.
18	[Lamp] button 	Turns the LED on the camera on or off.

	Name	Function
19	[Resolution] button 	Lets you switch between the multiple resolution settings. Each press of the buttons switches the mode in the order shown below. <b>3840x2160 @ 60</b> <b>3840x2160 @ 30</b> <b>1920x1080</b> <b>1280x720</b> <b>1024x768</b>
20	[DC/PC] button 	Lets you switch projected images between images from the document camera and images from a connected computer. Press this during a slideshow or playback of a video to return to the camera mode.
21	[Record] button 	Starts and stops video recording.
22	[Playback] button 	Starts or stops playback of a video.
23	Remote control light-emitting area	Outputs remote control signals.

Name	LED Status and Meaning
Power supply [🔌]	Lights orange: The document camera is in standby mode Flashes orange: The document camera is warming up Lights blue: Start-up of the document camera has been completed
WiFi [📶 ○]	Flashes blue rapidly: The document camera is searching for a Miracast compatible device Flashes blue slowly: The document camera is connected via Miracast

# Connecting

Follow the instructions in this section to set up the document camera.

The document camera can be connected directly to a projector, external monitor, or other video device using the HDMI cable. It can also be connected via Miracast.



You can also connect the document camera to a projector through a computer.

☛ "Connecting to a Projector using Software" [p.24](#)



When image devices that support the HDMI CEC standard are connected to the document camera, operations for the document camera and the image device can be linked together. Set **HDMI Link** on the document camera. ☛ **System - HDMI Link** [p.43](#)

For necessary settings on the image device, see the documentation provided with the device.

## Connecting Using the HDMI Cable

Connect the HDMI port on the document camera with a projector using the included HDMI cable. Images (live or on a USB flash drive) from the document camera are output from the projector.

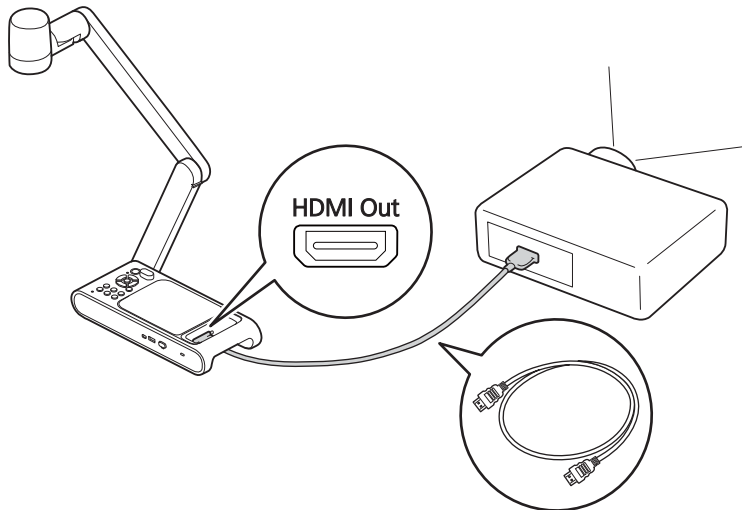

## Connecting to a Projector via Miracast

You can connect the document camera to a projector via Miracast and project images.

To connect, first display the on-screen menu on an HDMI monitor and configure the Miracast settings.

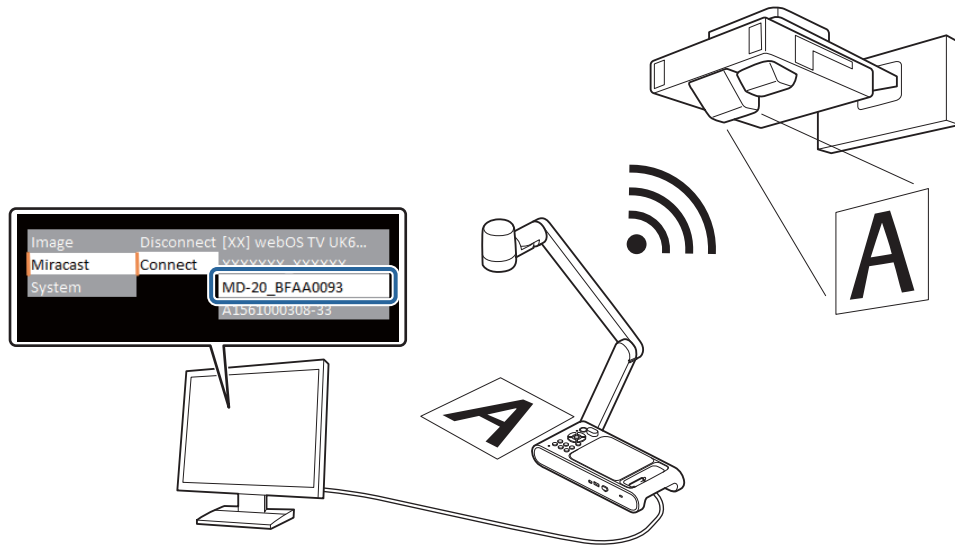

- When connecting via Miracast for the first time, it may take some time to connect.
- When connecting via Miracast, recording and playback are not possible.

**1** Connect the HDMI Out port on the document camera with an HDMI monitor using the HDMI cable.

**2** Turn on the document camera.  
 "Plugging In and Turning On" p.28



Make sure that the document camera and a projector are not connected with a USB cable. If they are connected, Miracast settings cannot be made.

**3** Turn on the HDMI monitor.

**4** Press the button on the document camera.  
 The on-screen menu appears on the HDMI monitor.  
 "Using the On-screen Menu" p.41

**5** Open the **Miracast** menu and select **Connect** to view a list of devices that can be connected.

**6** Select the projector you want to connect from the list and press the [Enter] button.  
 The connection to the selected projector is completed, and the projector will project the image from the document camera.



To find out the name of the Epson projector to be connected, use the projector to display the source selection screen and select **Screen Mirroring**.

For details, refer to the *Operation Guide* of your projector.

## When Using a Computer

By connecting the computer to the HDMI In port and the projector to the HDMI Out port, images of PowerPoint files and other applications on the computer can be projected from the projector.

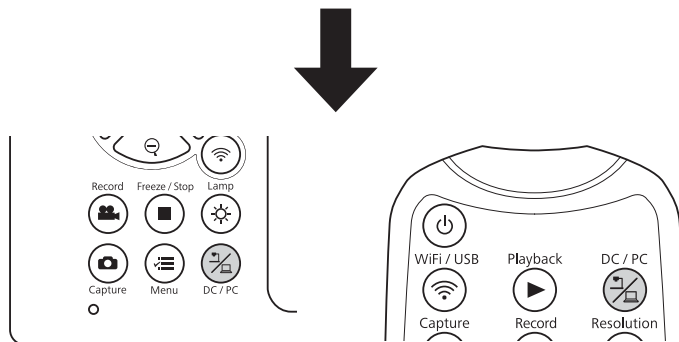
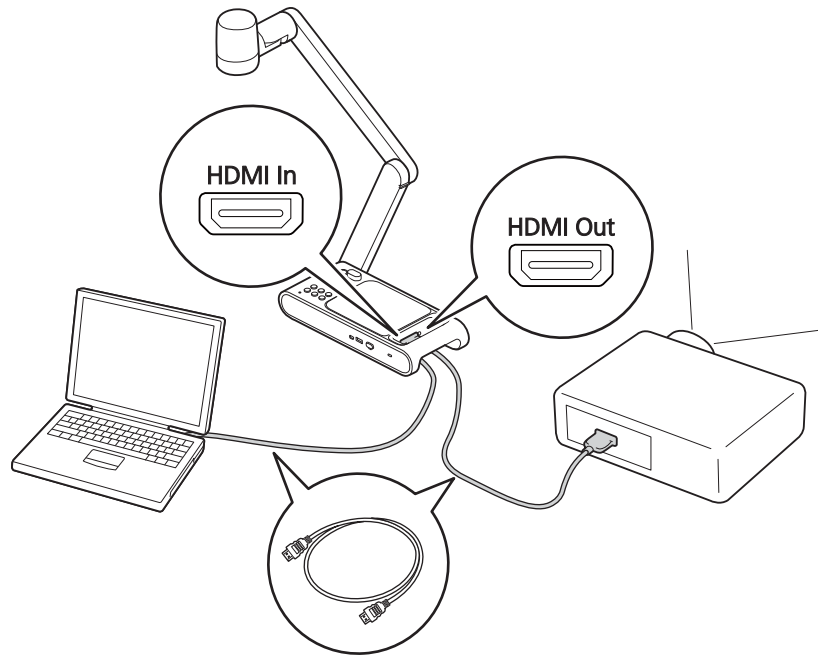

Images on the computer connected to the document camera are only output from the HDMI Out port.

The projected image can be switched between the computer images and the images from the document camera (live image or image on a USB flash drive) using the [DC/PC] button on the document camera or the remote control.

## Using Easy Interactive Tools

By using the camera screen of Easy Interactive Tools, you can display images from the document camera on a computer connected via a USB cable. You can adjust the size, brightness, etc. of the images on the computer and save it as an image file or a video file. If you want to project the images from the document camera, connect the computer to a projector.

Download Easy Interactive Tools from the following website.

<http://epson.sn/>

**1** Connect the USB Mini-B port on the document camera to a computer using a USB cable.

**2** Connect the computer to a projector.

The cable used to create the connection differs depending on the computer and projector you are using. See the documentation provided with the computer and projector you are using.

For more details on Easy Interactive Tools, see the Easy Interactive Tools Operation Guide.

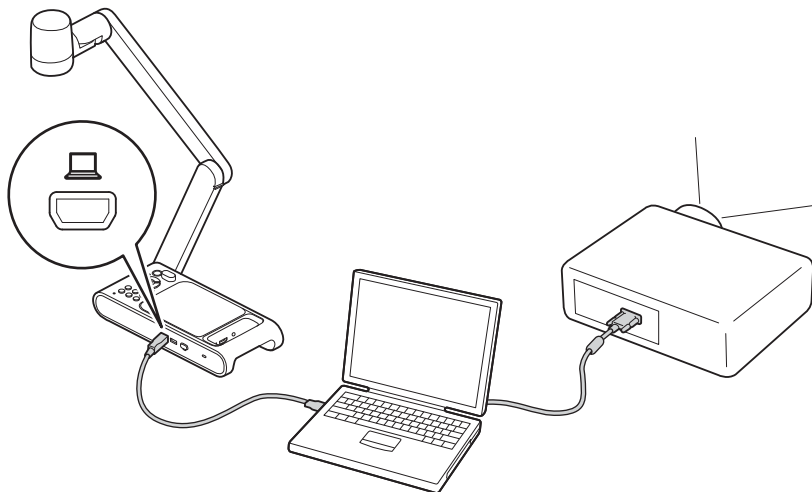

- You cannot project images by directly connecting the document camera to a projector with a USB cable.
- Connect the document camera to a USB 2.0 port of a computer. If you connect it to a USB 3.0 port, it may not function properly.
- Do not connect multiple document cameras to one computer at the same time.
- When projecting an image using a projector that supports the interactive pen or touch operations, you can operate the Easy Interactive Tools on the projected image.



## Using Epson Connect Tool for Document Camera

By using the software Epson Connect Tool for Document Camera, you can connect the document camera to a projector via Miracast using the computer.

Download Epson Connect Tool for Document Camera from the following website.

<http://epson.sn/>

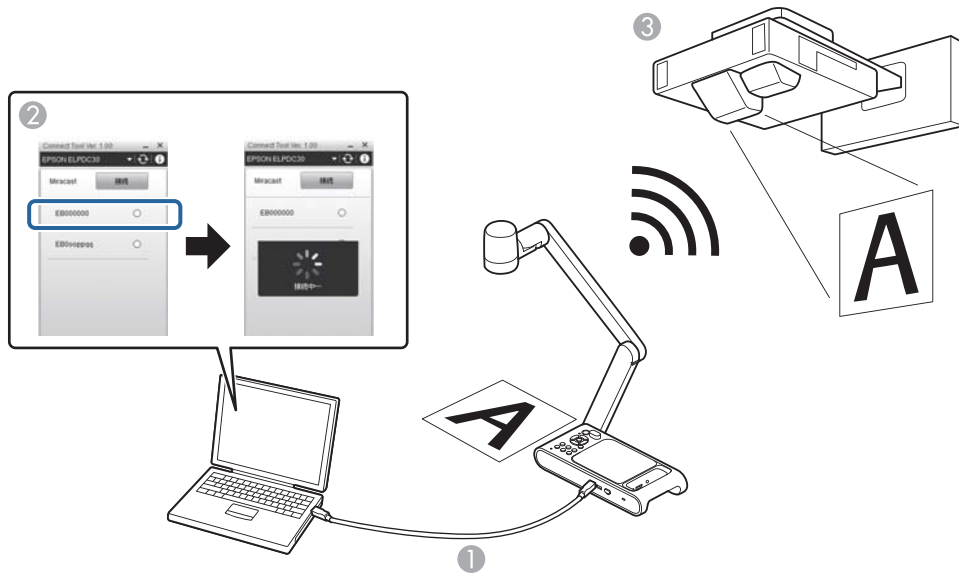

- 1** Connect the USB Mini-B port on the document camera to a computer using a USB cable.
- 2** On the computer, start Epson Connect Tool for Document Camera.

- 3** On the screen that appears, select the projector you want to connect via Miracast.

Once the connection is made, the image being captured by the document camera is projected by the projector.



When connecting the document camera via Miracast, the USB connection with the computer is disconnected.

**Projecting**

- 1** Raise the camera arm with one hand while holding the base of the camera with your other hand.

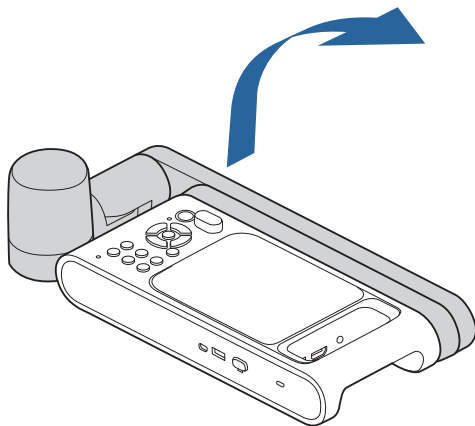

- 2** Position the camera head above the projection area.

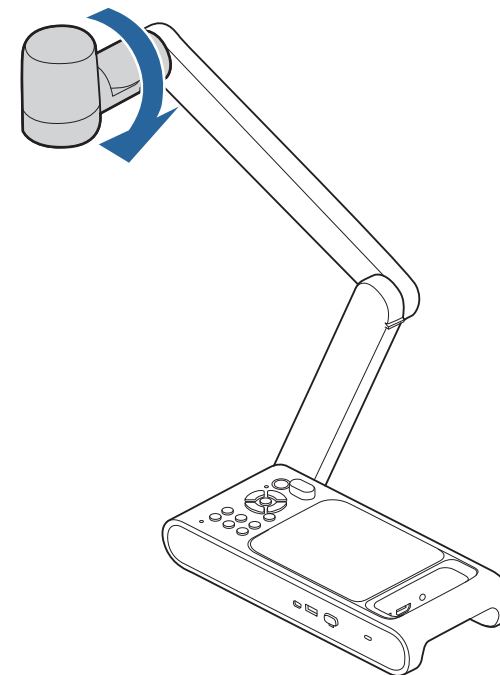

Connect the document camera to the projector with a cable before turning on the document camera. 📖 "Connecting" p.20

- 1** Connect the power cord as shown and plug the cord into a wall outlet.



Use the included AC adapter.

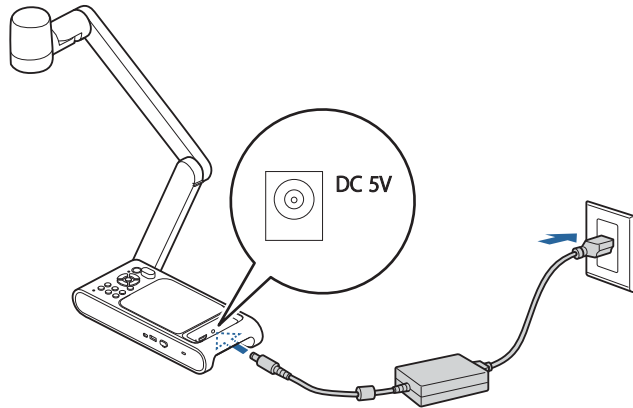

- 2** Press the [⏻] power button on the document camera or remote control.

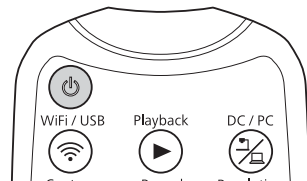
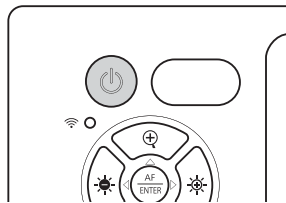

The power indicator flashes orange. When startup is complete, the power indicator stops flashing and lights blue. Startup takes approximately 20 seconds.

- 3** Turn on your projector.
- 4** Select the appropriate source on the projector depending on the port to which you connected.  
Live images from the document camera are projected from the projector.

**1** Place your document on the table under the camera head.



- The maximum paper size that can be projected is A3 landscape.
- When projecting A3-size document, open the **Image** menu, and set **Image Mode** to **Wide Angle**.

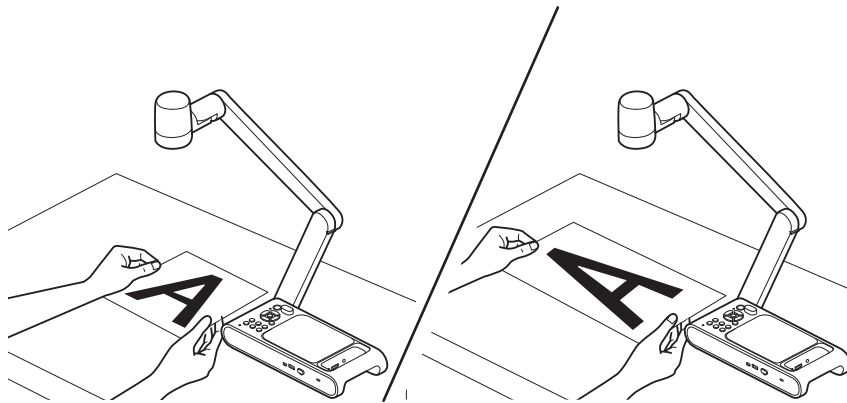

**2** Press the [☀️] button to illuminate the document.

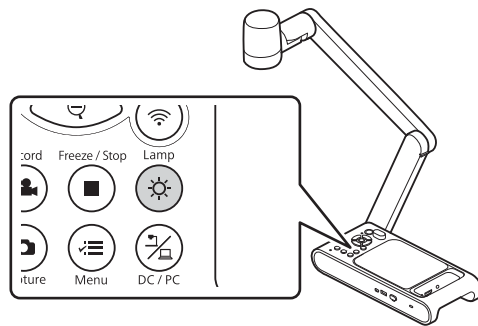

If necessary, you can adjust the brightness of the image using the [☀️] or [☁️] on the document camera or remote control.

**3** Press the [AF] button on the document camera or remote control.

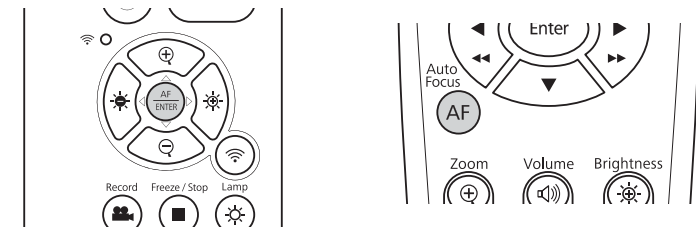

The focus is adjusted automatically.

**4** To zoom in on part of the image, press the [⊕] button on the document camera or remote control. Press the [⊖] button to zoom out.

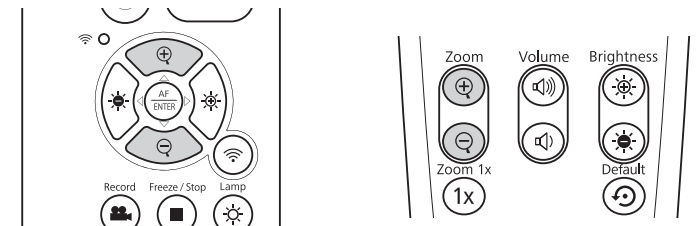

- You can zoom up to 10x optically and 23x digitally. (When the optical zoom rate reaches the maximum value, it switches to the digital zoom.)
- Image quality declines when using the digital zoom function.

## Switching the Projected Image

When a computer is connected to the document camera, you can switch the image projected from the projector using the  button on the document camera or the remote control.

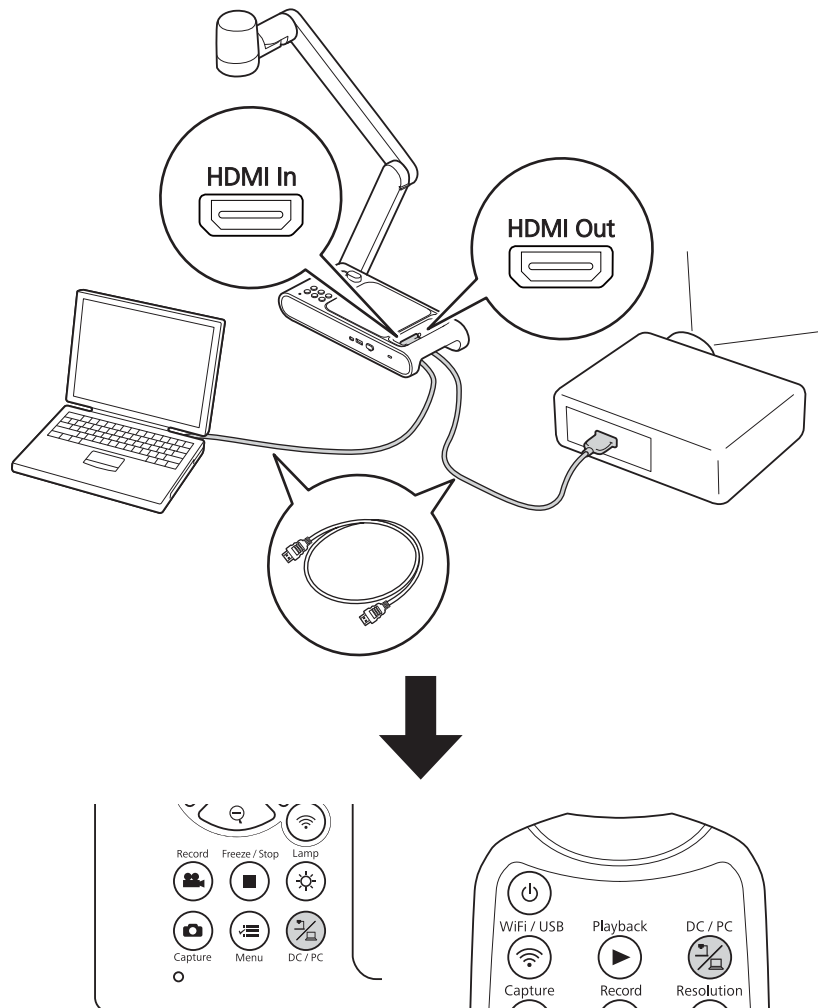



## Freezing an Image

To freeze the image, press the  button on the document camera or remote control.

After freezing the image, you can remove your document while leaving its image displayed on the screen. Place your next document under the camera lens and press the  button again; your presentation continues without interruption.

## Projecting Small Objects

To project a small object, lower the camera arm. You can place the camera head within approximately 5 cm (2 inches) of the object.

To zoom in on part of the image, press the  button on the document camera or remote control. Press the  button to zoom out.

## Displaying Whiteboard Images

You can use the document camera to display a lecture or presentation at the front of a room, or to capture images of a whiteboard or chalkboard.



To flip the image upside down, press the [✓≡] button and open the **Image** menu, then set **Image Rotation** to **180 degrees**.

- 1 Rotate the camera head and set it in the direction of the object.

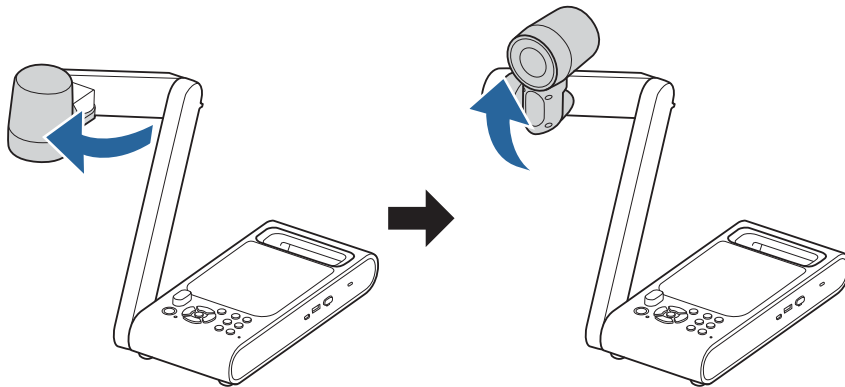

- 2 Press the [AF] button on the document camera or remote control.

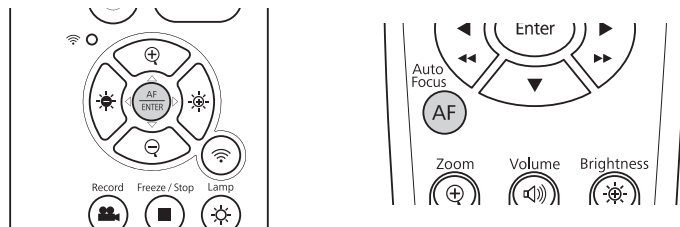

The image is automatically focused.



You can make an audio/video recording of your projection. The recorded images are saved in the USB flash drive.

☛ "Saving Videos" [p.37](#)

## Projecting Through a Microscope

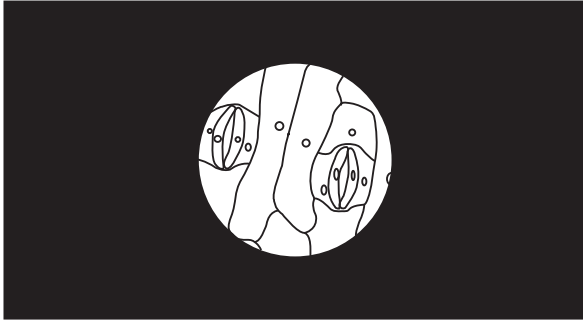

Projected image

To display objects as seen through a microscope, use the included microscope adapter.



- Before installing the document camera, make the following settings:
  - Focus the microscope and adjust the zoom
  - Press the [✓≡] button and open the **Image** menu, then set **Image Mode** to **Microscope**.
- Images may not be displayed correctly depending on the optical properties of your microscope.

**1** Loosely attach the screws to the microscope adapter.

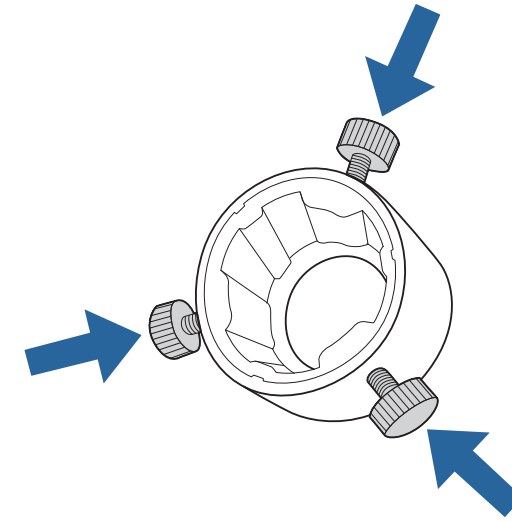

**2** Attach the microscope adapter to the camera head of the document camera, and rotate the adapter to fix it in place.

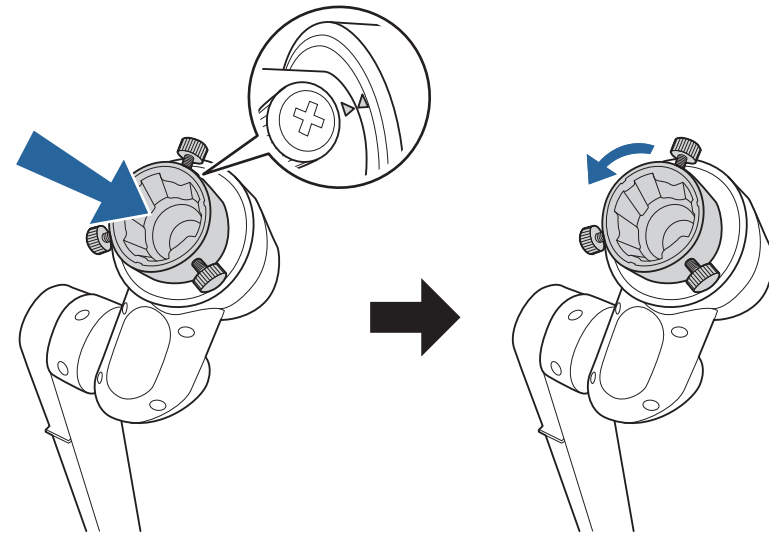



- 3** Attach the microscope adapter to the microscope eyepiece and secure the adapter by tightening the screws.

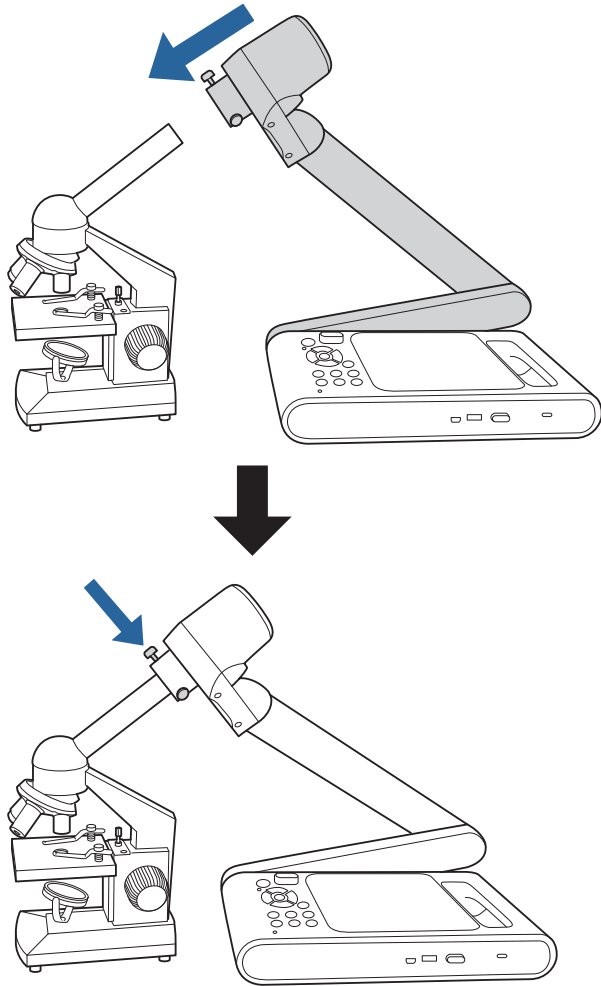

Turn off the document camera after use.

- 1** Press the [⏻] power button on the document camera or remote control.

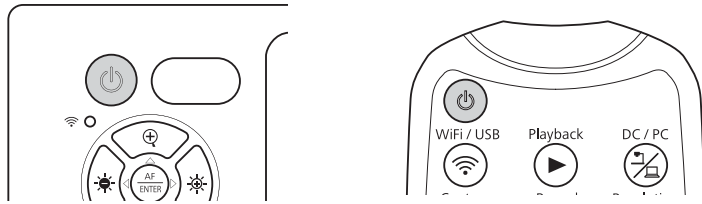

The projected image disappears, and the power indicator shows standby state (lights orange).

- 2** Disconnect the power cord and any other connected cables, and then fold down the camera arm.

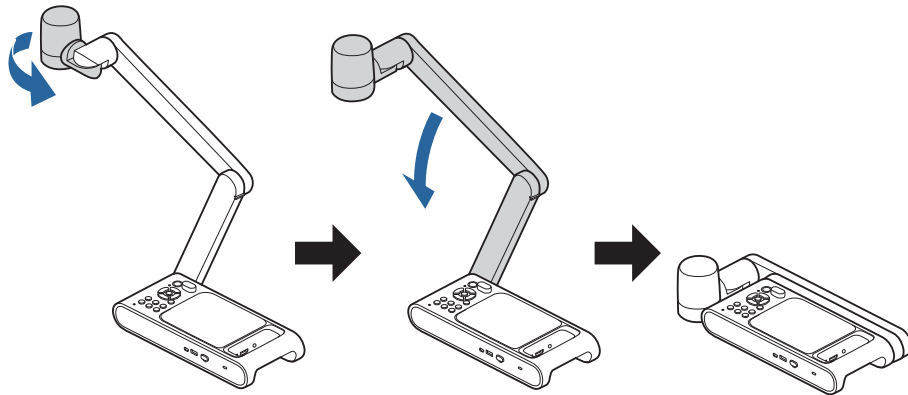

# Saving Images and Playing a Slideshow or Video

You can save live images captured by the document camera to a USB flash drive. You can play a slideshow with the saved still images or play the saved videos.

This section explains how to perform operations using the document camera or the remote control. You can save images using software on your computer.

☛ "Using Easy Interactive Tools" [p.24](#)

You can save images captured by the document camera to a USB flash drive as still images.



- Images are saved in JPEG format at the resolution set in the **Output Resolution** setting of the document camera. The maximum resolution that can be saved is 4K.
- If the USB flash drive is low on space, the message “Storage Full” is displayed, and the image is not saved.

- 1** Connect a commercially available USB flash drive to the document camera.

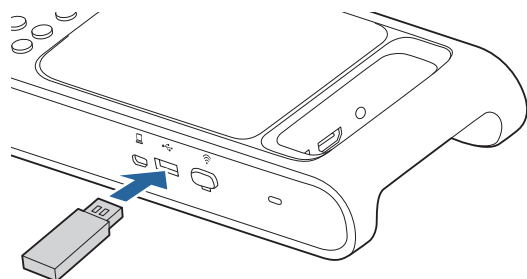

- 2** Project the image you want to save.

- 3** Press the [📷] button to capture the image.

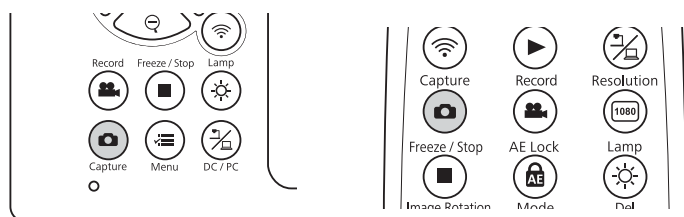

The 📷 icon appears in the center of the screen and the captured image is saved to the USB flash drive.

- 4** Repeat steps 2 and 3 for any additional images you want to save.

You can save images and audio from the document camera to a USB flash drive as video.



- Videos are saved in mp4 format at the resolution set in the **Output Resolution** setting of the document camera.
- The maximum size that can be recorded in one file is 2 GB.
- If the USB flash drive is low on space, the message “Storage Full” is displayed, and the video is not saved.
- Set **Sleep Mode** to **Off** to prevent the power turning off while recording. **System - Sleep Mode p.43**

**1** Connect a commercially available USB flash drive to the document camera.

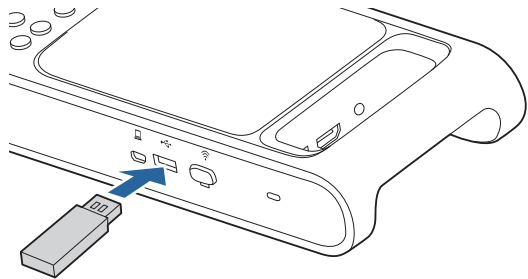

**2** Project the image you want to save.

**3** Press the button to start recording.

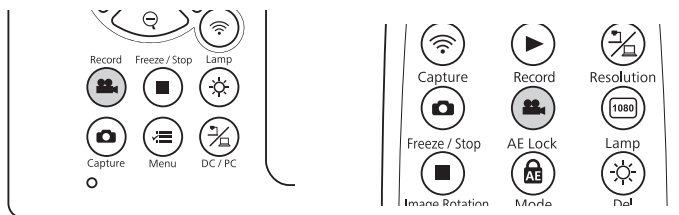

- While recording, the elapsed time is displayed at the top right of the screen. This is not displayed on the saved image.
- Do not disconnect the USB flash drive while recording.
- The following buttons can be operated while recording. [Zoom], [Zoom 1x], [Auto Focus], [Brightness], [Image Rotation], [Lamp]  
Note that operation sounds are also recorded.
- Even if you connect the document camera to another device with a USB cable, it will not connect while recording.

**4** To stop recording, press the button again.

You can play a slideshow with the images saved on a USB flash drive.

This function is unavailable in the following situations.

- When the document camera is connected to a computer with a USB cable
- When the document camera is connected via Miracast
- When recording a video

Files that can be played as a slideshow

Type	File Type	Notes
Still images	JPEG	Files with a resolution of less than 3840 x 2160
Videos	mp4	Files less than 2 GB in size



Only images captured by the document camera can be displayed in the slideshow.

👉 "Problems related to USB Flash Drive" [p.48](#)

- 1 Press the [▶] button on the remote control while the live image is being projected.

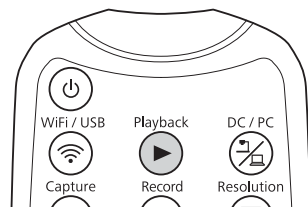

Thumbnails of the images on the USB flash drive are displayed.



- 2 Press the [☰] button and open the **Playback** menu, then select **Slide Show - Start**.

A slideshow will begin.



Press the [▶] button again to stop the slideshow and return to the thumbnail screen.

- 3 Press the [☰] button to display the slideshow related menus; **Slide Show**, **Interval**, and **Delete All**.

- 4 To end the slideshow, press the [▶] button on the remote control.

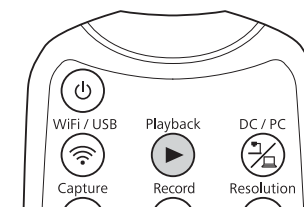

- 1 Press the [▶] button on the remote control while the live image is being projected.

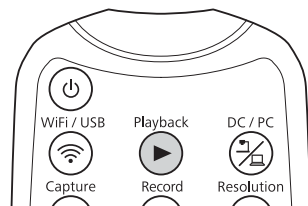

Thumbnails of the images on the USB flash drive are displayed.



- 2 Select an image or video you want to show and start displaying the image or playing the video.

- Still images

Select an image using the arrow buttons

([▲] [▼] [◀/◄◄] [▶/▶▶]) on the remote control, and then press the [Enter] button.

- Videos

Press the [Enter] button to display a full-screen preview of the video you want to play, then press the [Enter] button again.

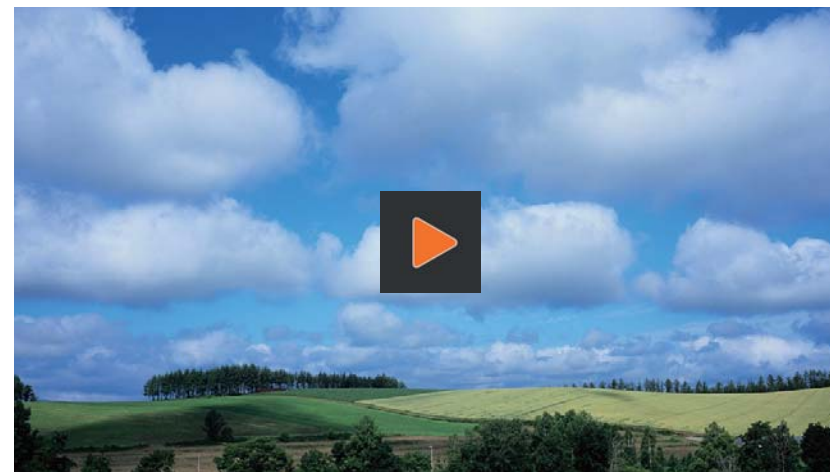

To pause or resume the video, press the [Enter] button.

Press the [■] button during video playback to exit the video.

# Image Adjustments and Effects

The document camera provides a full range of image adjustments and effects, including freeze image, black-and-white, and the ability to change the display for color images.



Press the [☰] button on the control panel or remote control to view the on-screen menu. See the following for details on each item in the on-screen menu.

☛ "On-Screen Menu Table" p.42

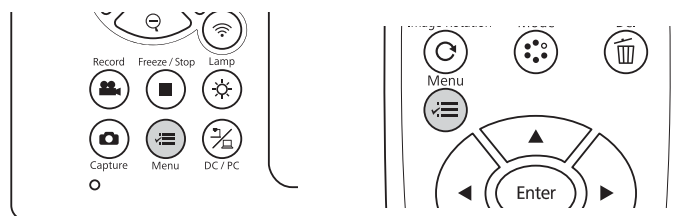

select a setting. When you are done adjusting the settings, press the [☰] button to close the menu and save your settings.

 The menu cannot be displayed when the document camera is connected to a computer with a USB cable.

The following menu is displayed:

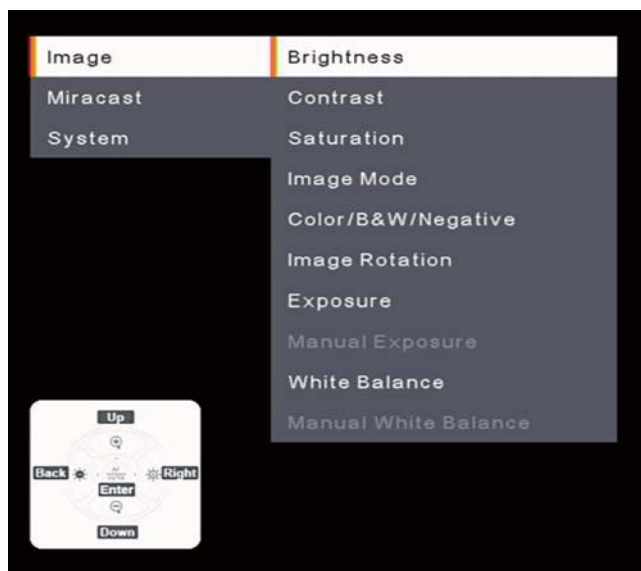

Use the arrow buttons ([▲] [▼] [◀/◄◄] [▶/▶▶]) on the remote control to navigate the menu and adjust the settings. Press the [Enter] button to

## Image

The **Image** menu allows you to adjust the quality of the live video image.

Setup Item	Explanation
<b>Brightness</b>	The brightness level can be manually adjusted in the range of 0 to 255. To lighten the screen, select + and hold down the [Enter] button. To darken the screen, select – and hold down the [Enter] button. The brightness can also be changed using the [☉] and [☉] buttons on the control panel.
<b>Contrast</b>	The contrast level can be manually adjusted in the range of 0 to 255. To increase the contrast, select + and hold down the [Enter] button. To decrease the contrast, select – and hold down the [Enter] button.
<b>Saturation</b>	The saturation level can be manually adjusted in the range of 0 to 255. To make the image more vivid, select + and hold down the [Enter] button. To make the image more subdued, select – and hold down the [Enter] button.
<b>Image Mode</b>	You can choose from the following options. <b>Normal*</b> : Standard shooting mode. <b>Motion</b> : Mode for fast-moving images. <b>Wide Angle</b> : Mode for wide-angle images. Use this option when shooting A3-size document. <b>Microscope</b> : Mode for images of a connected microscope. <b>Macro</b> : Mode for capturing close subjects. <b>Infinity</b> : Mode for capturing distant subjects. Image mode cannot be changed when connected via Miracast.
<b>Color/B&amp;W/Negative</b>	Select the display method for color images. <b>Color*</b> : Displays the image in color. <b>Black&amp;White</b> : Displays the image in black-and-white. <b>Negative</b> : Displays a photographic negative in true color.
<b>Image Rotation</b>	Lets you rotate the image. <b>Normal*</b> : Displays the image as it actually is. <b>180 degrees</b> : Displays the image upside-down.
<b>Exposure</b>	<b>Auto*</b> : Automatically adjusts exposure. <b>Manual</b> : Manual exposure setting is enabled.

Setup Item	Explanation
<b>Manual Exposure</b>	When <b>Manual</b> is selected for <b>Exposure</b> , the exposure setting can be manually changed in the range of 0 to 99. To increase the value, select + and hold down the [Enter] button. To decrease the value, select – and hold down the [Enter] button.
<b>White Balance</b>	Select the setting according to the lighting in the room where you are using the document camera. <b>Auto*</b> : Automatically adjusts the image color according to the display environment. <b>Manual</b> : Lets you change the colors of the image manually. You can choose from the following options. <b>Cloudy</b> : Suitable for use in cloudy weather. <b>Daylight</b> : Suitable for use in fair weather. <b>Fluorescent</b> : Suitable for use in a room with fluorescent lighting. <b>Incandescent</b> : Suitable for use in a room with incandescent lamps.
<b>Manual White Balance</b>	The white balance can be manually adjusted in the range of 2800K to 10000K. To increase the value, select + and hold down the [Enter] button. To decrease the value, select – and hold down the [Enter] button.

\* Default setting at time of purchase

## Miracast

The **Miracast** menu allows you to make Miracast connection settings.

Setup Item	Explanation
<b>Disconnect</b>	Select this option to disconnect Miracast connection.
<b>Connect</b>	A list of devices that can be connected is displayed. Select a device you want to connect from the list.

## System

The **System** menu allows you to change various document camera settings.

Setup Item	Explanation
<b>Language</b>	Changes the on-screen menu language.

Setup Item	Explanation
<b>Output Resolution</b>	Sets the output resolution when connecting an HDMI cable to the HDMI port. You can select the maximum resolution of your output device from the following options. The highest one is the maximum resolution that the document camera can support. <b>3840x2160 @ 60</b> <b>3840x2160 @ 30</b> <b>1920x1080</b> <b>1280x720</b> <b>1024x768</b> This menu is not available when connected via Miracast.
<b>USB Streaming Format</b>	You can enable H.264 so that H.264 can be selected as the streaming format when connecting via USB. <b>H.264 On:</b> Enables H.264. <b>H.264 Off:</b> Disables H.264.
<b>Flickerless</b>	Eliminates flicker when giving presentations in regions with different electrical systems. <b>50Hz</b> <b>60Hz</b>
<b>HDMI Link</b>	When an image device that supports the HDMI CEC standard is connected to the document camera, operations for the document camera and the image device can be linked together. When this is set to <b>On*</b> , the connected device turns on when the document camera is turned on. A change to this setting takes effect after the document camera is turned off.
<b>Sleep Mode</b>	Operation settings when the document camera is inactive. <b>On:</b> The power automatically turns off if the document camera is inactive for a certain amount of time. <b>Off:</b> The power remains on even if the document camera is inactive for a certain amount of time.
<b>Sleep Mode Timer</b>	Sets the amount of time, in the range of 1 to 6 hours, before the document camera automatically turns off.
<b>Mic. Volume</b>	The volume of the built-in microphone can be manually adjusted. To increase the volume, select + and hold down the [Enter] button. To decrease the volume, select – and hold down the [Enter] button.
<b>Information</b>	Displays the product name, firmware version, and MAC address of the document camera.
<b>Reset</b>	Resets the menu settings to factory defaults.

\* Default setting at time of purchase

## Playback Mode

This menu allows you to make settings for playing back and projecting images or videos saved by the document camera.



This menu is available when a commercially available USB flash drive is connected to the document camera.

This menu is not available when the document camera is in the following states.

- It is connected via Miracast
- It is connected using a USB cable

Setup Item	Explanation
<b>Slide Show</b>	Starts or pauses a slideshow. Press the [▶] button on the remote control to end the slideshow.
<b>Interval</b>	Sets how long each image or video should appear in the slideshow, in the range of 1 to 100 seconds, before proceeding to the next one. Press + to make the time longer, and press – to make the time shorter.
<b>Delete All</b>	Delete all images and videos saved in the USB flash drive.

# Solving Problems

## Operation Problems

### No image appears on the screen

- After you press the [⏻] power button, wait a few moments for the image to appear. It takes approximately 20 seconds for the document camera to output an image.
- Make sure all necessary cables are securely connected and the power is on for the projector and the document camera.
  - ☛ "Connecting the Document Camera to a Projector" p.21
  - ☛ "Connecting to a Projector using Software" p.24
- To project live images from the document camera, press the [📷] button on the document camera or the remote control.
- Select the correct source on your projector. The source refers to the port on the projector to which you have connected the cable.
- Make sure your projector is turned on and not in sleep mode. Make sure the image has not been "muted" or turned off. Check that the document camera is not in sleep mode.
- Reconnect the power cord. If no images are output even after pressing the [⏻] power button again, stop using the document camera, contact your local dealer or the nearest service center provided in this guide. ☛ "Epson Projector Contact List" p.49

## Image Quality Problems

### The image is fuzzy or out of focus

- If the surroundings are dark and the contrast in the projected image is low, the document camera's auto focus function may not work correctly. Adjust **Brightness** and/or **Contrast** in the **Image** menu.
- Make sure the camera head is at least 5 cm (2 inches) away from the object you are viewing.
  - ☛ "Zoom Magnification and Projection Distance by Image Mode" p.58
- If you are using a projector to display the image, check its focus.

- If the zoom magnification is too high, the focus point may be out of the angle of view. Try reducing the zoom magnification.

### The image brightness or colors are incorrect

- Press the [☀️] button to illuminate the subject.
- Press the [☀️] or [🌑] button to increase or decrease image brightness.
- Set the **White Balance** setting to **Auto** to adjust the color automatically. If the colors are still not correct, select the best setting for the type of lighting in your environment (**Cloudy**, **Daylight**, **Fluorescent**, or **Incandescent**).
  - ☛ "Image" p.42
- If you connected a microscope to the document camera and set the image mode to **Microscope**, be sure to change the **Microscope** setting to another mode before using the document camera without connecting a microscope.
  - ☛ "Image" p.42

### Cannot focus on a three dimensional subject

If the subject is a three-dimensional object, the following will make it easier to bring it into focus.

- Place a uniformly colored object of A3 size or larger as a background for the three-dimensional subject.
- Before placing the three-dimensional subject, focus on the position where the subject will be placed.

### Other image problems

- If the image is stretched or has black bars, change **Output Resolution** in the **System** menu.
  - ☛ "System" p.43



To return all image settings to their initial values, select the **Reset** menu.

☞ "Image" [p.42](#)

---

## Problems related to USB Flash Drive

### Some images do not appear

Check the file format when copying images to the USB flash drive from a computer.

- The file format of the images must be JPEG. Do not edit the images, as this may change their format and prevent them from being displayed.
- Videos and still images not captured by the document camera cannot be played back. Files whose images are not displayed on the thumbnail screen were not taken with the document camera.

---

## Miracast Problems

### Takes time to connect

- It may take some time to connect. Restart the device you are connecting to after a while.
- Check the settings.
  - ☞ "Connecting to a Projector via Miracast" [p.22](#)

---

## Remote Control Problems

### Remote control does not work

You may be operating the remote control outside its effective range. Check the effective range of the remote control.

☞ "Specifications" [p.55](#)



See the following contact list if any problems occur when using the document camera outside Japan.

See the Web Home Page provided with each contact for the latest contact information. If the country you are in is not provided, see the main home page, [www.epson.com](http://www.epson.com).

---

## EUROPE

### ALBANIA

ITD Sh.p.k.

<https://www.itd-al.com>

### AUSTRIA

Epson Deutschland GmbH

<http://www.epson.at>

### BELGIUM

Epson Europe B.V.  
Branch office Belgium

<https://www.epson.be>

### BOSNIA AND HERZEGOVINA

NET d.o.o. Computer Engineering

<https://netcomp.rs>

### BULGARIA

Epson Service Center, Bulgaria

<http://www.kolbis.com>

### CROATIA

MR servis d.o.o.

<http://www.mrservis.hr>

### CYPRUS

A.T. Multitech Corporation Ltd.

<http://www.multitech.com.cy>

### CZECH REPUBLIC

Epson Europe B.V.  
Branch Office Czech Republic

<https://www.epson.cz>

### DENMARK

Epson Denmark

<https://www.epson.dk>

### ESTONIA

Epson Service Center, Estonia

<http://www.epson.ee>

### FINLAND

Epson Finland

<http://www.epson.fi>

### FRANCE and DOM-TOM TERRITORIES

Epson France S.A.

<https://www.epson.fr>

### GERMANY

Epson Deutschland GmbH

<https://www.epson.de>

## GREECE

**Info Quest Technologies S.A.**

<https://www.infoquest.gr>

## HUNGARY

**Epson Europe B.V.  
Branch Office Hungary**

<https://www.epson.hu>

## IRELAND

**Epson (UK) Ltd.**

<https://www.epson.ie>

## ISRAEL

**Epson Israel**

<https://www.epson.co.il>

## ITALY

**Epson Italia s.p.a.**

<https://www.epson.it>

## KAZAKHSTAN

**Epson Kazakhstan Rep. Office**

<http://www.epson.kz>

## LATVIA

**Epson Service Center, Latvia**

<http://www.epson.lv>

## LITHUANIA

**Epson Service Center Lithuania**

<http://www.epson.lt>

## LUXEMBURG

**Epson Europe B.V. Branch office Belgium**

<https://www.epson.be>

## NORTH MACEDONIA

**Digit Computer Engineering**

<http://www.digit.com.mk>

## NETHERLANDS

**Epson Europe B.V. Benelux sales office**

<https://www.epson.nl>

## NORWAY

**Epson Norway**

<https://www.epson.no>

## POLAND

**Epson EUROPE B.V. Branch Office Poland**

<https://www.epson.pl>

## PORTUGAL

**Epson Iberica S.A.U. Branch Office Portugal**

<https://www.epson.pt>

## ROMANIA

**Epson Europe B.V. Branch Office Romania**

<https://www.epson.ro>

## RUSSIA

**Epson CIS**

<https://epson.ru>

## UKRAINE

**Epson Kiev Rep Office**

<http://www.epson.ua>

## SERBIA

**Nepo System d.o.o.**

<https://neposystem.rs>

**AIGO Business System d.o.o. Beograd**

<https://aigo.rs>

## SLOVAKIA

**Epson EUROPE B.V. Branch Office Czech Republic**

<https://www.epson.sk>

## SLOVENIA

**Birotehna d.o.o**

<http://www.birotehna.si>

## SPAIN

**Epson Iberica, S.A.U.**

<https://www.epson.es>

## SWEDEN

**Epson Sweden**

<https://www.epson.se>

## SWITZERLAND

**Epson Deutschland GmbH Branch office Switzerland**

<https://www.epson.ch>

## TURKEY

**Tecpro Bilgi Teknolojileri Tic. ve San. Ltd. Sti.**

<http://www.tecpro.com.tr>

## UK

**Epson (UK) Ltd.**

<https://www.epson.co.uk>

### Indication of the manufacturer and the importer in accordance with requirements of United Kingdom directive

Manufacturer: SEIKO EPSON CORPORATION  
Address: 3-5, Owa 3-chome, Suwa-shi, Nagano-ken 392-8502 Japan  
Telephone: 81-266-52-3131  
<http://www.epson.com/>

Importer: Epson (UK) Ltd.  
Address: Westside, London Road, Hemel Hempstead, Hertfordshire, HP3 9TD, United Kingdom  
<http://www.epson.co.uk>

### Indication of the manufacturer and the importer in accordance with requirements of EU directive

Manufacturer: SEIKO EPSON CORPORATION  
Address: 3-5, Owa 3-chome, Suwa-shi, Nagano-ken 392-8502 Japan  
Telephone: 81-266-52-3131  
<http://www.epson.com/>

Importer: EPSON EUROPE B.V.  
Address: Atlas Arena, Asia Building, Hoogoorddreef 5, 1101 BA Amsterdam  
Zuidoost The Netherlands  
Telephone: 31-20-314-5000  
<http://www.epson.com/europe.html>

---

## AFRICA

<https://www.epson.co.za>  
or  
<https://www.epson.fr>

### SOUTH AFRICA

**Epson South Africa**

<https://www.epson.co.za>

<https://www.epson.com.mx>

### ECUADOR

**Epson Ecuador**

<https://epson.com.ec>

### U. S. A.

**Epson America, Inc.**

<https://epson.com/usa>

---

## MIDDLE EAST

**Epson (Middle East)**

<https://www.epson.ae>

---

## NORTH, CENTRAL AMERICA & CARIBBEAN ISLANDS

### CANADA

**Epson Canada, Ltd.**

<https://www.epson.ca>

### COSTA RICA

**Epson Costa Rica, S.A.**

<https://epson.co.cr>

### MEXICO

**Epson Mexico, S.A. de C.V.**

---

## SOUTH AMERICA

### ARGENTINA

**Epson Argentina S.R.L.**

<https://www.epson.com.ar>

### BRAZIL

**Epson do Brasil**

<https://epson.com.br>

### CHILE

**Epson Chile S.A.**

<https://epson.cl>

### COLOMBIA

**Epson Colombia Ltd.**

<https://epson.com.co>

### PERU

**Epson Peru S.A.**

<https://epson.com.pe>

## VENEZUELA

**Epson Venezuela S.A.**

<https://epson.com.ve>

---

## ASIA AND OCEANIA (Country/Region)

### AUSTRALIA

**Epson Australia Pty. Ltd.**

<https://www.epson.com.au>

### CHINA

**Epson (CHINA) CO., Ltd.**

<https://www.epson.com.cn>

### HONG KONG

**Epson Hong Kong Ltd.**

<https://www.epson.com.hk>

### INDIA

**Epson India Pvt., Ltd.**

<https://www.epson.co.in>

### INDONESIA

**PT. Epson Indonesia**

<https://www.epson.co.id>

### JAPAN

**Seiko Epson Co.**

<https://www.epson.jp>

## KOREA

**Epson Korea Co., Ltd.**

<http://www.epson.co.kr>

## MALAYSIA

**Epson Malaysia Sdn. Bhd.**

<https://www.epson.com.my>

## NEW ZEALAND

**Epson New Zealand**

<https://www.epson.co.nz>

## PHILIPPINES

**Epson Philippines Co.**

<https://www.epson.com.ph>

## SINGAPORE

**Epson Singapore Pte. Ltd.**

<https://www.epson.com.sg>

## TAIWAN

**Epson Taiwan  
Technology & Trading Ltd.**

<https://www.epson.com.tw>

## THAILAND

**Epson (Thailand) Co., Ltd.**

<https://www.epson.co.th>

# Appendix

## General Specifications

<b>Product name</b>		ELPDC30
<b>Dimensions</b>		Open (W × D × H): 586 × 554 × 159 mm (23.1 × 21.8 × 6.3 inches) Folded (W × D × H): 362 × 85 × 159 mm (14.3 × 3.3 × 6.3 inches)
<b>Type of sensor</b>		1/3.2 inch CMOS sensor
<b>Lens</b>		F=2.8
<b>Effective pixels</b>		4K (3840 × 2160 pixels)
<b>Imaging area</b>		Up to 345 × 480 mm @ 470 mm (in the <b>Wide Angle</b> mode)
<b>Focus adjustment</b>		Automatic Auto focus is possible even after zoom adjustment
<b>Zoom adjustment</b>		10x optical zoom (at infinity) 23x digital zoom
<b>Frame rate</b>		Up to 60 fps
<b>Internal microphone</b>		1 (monaural input)
<b>Remote control effective range</b>		5 m from the front, right, and left of the document camera 6 m at a 45 degree angle from the left and right sides of the document camera
<b>Power supply</b>	<b>AC adapter</b>	100 to 240 VAC ±10%, 50/60 Hz, 0.5 A
	<b>Main unit (FSP015-DPAN3)</b>	5 VDC, 3 A, 15.0 W
<b>Power consumption</b>	<b>Operating</b>	With LED lamp on: 9.6 W With LED lamp off: 8.0 W
	<b>Standby</b>	0.5 W
<b>Operating temperature</b>		+5 to +35 degrees C, without condensation
<b>Storage temperature</b>		-10 to +60 degrees C, without condensation
<b>Operating humidity</b>		20 to 80% RH, without condensation
<b>Storage humidity</b>		10 to 90% RH, without condensation
<b>Weight</b>		Approx. 2.8 kg (6.1 lb)

<b>Input port</b>	<b>HDMI port*1</b>	<b>1</b>	---
<b>Output port</b>	<b>HDMI port*1</b>	<b>1</b>	---
<b>Connector port</b>	<b>miniUSB*2</b>	<b>1</b>	This can also be used as an output port
	<b>USB-A*2</b>	<b>2</b>	1: Wi-Fi dongle 1: USB Flash Drive

\*1: HDMI CEC is supported. However, the operation of all compatible devices is not guaranteed.

\*2: USB 2.0 is supported. However, the operation of all USB compatible devices is not guaranteed.

This product is also designed for IT power distribution system with phase-to-phase voltage 230V.

Indications regarding the manufacturer, model name, and rating of the product can be found on the rating label on the bottom of the product.



## List of Supported Resolutions

<b>HDMI output</b>	4K (3840 × 2160 @ 30/60 Hz*1)
	HDTV (1920 × 1080 @ 60 Hz, 1280 × 720 @ 60 Hz)
	XGA (1024 × 764 @ 60 Hz)
<b>miniUSB output</b>	320 × 180 pixels
	320 × 240 pixels
	640 × 360 pixels
	VGA (640 × 480)
	XGA (1024 × 768)
	720p (1280 × 720)
	WXGA (1280 × 800)
	QVGA (1280 × 960)
	SXGA (1280 × 1024)
	Full HD (1920 × 1080)
	UXGA (1600 × 1200)
	2048*1536 pixels (2048 × 1536)
	2560*1920 pixels (2560 × 1920)
4K (3840 × 2160)	
<b>Miracast output</b>	Full HD (1920 × 1080)

\*1: Only 8-bit YUV format is available with the 3840 x 2160 @ 60 resolution.

## Zoom Magnification and Projection Distance by Image Mode

Image Mode	Shooting distance range	Maximum optical zoom magnification*1	Maximum digital zoom magnification*1	Aspect Ratio/Frame Rate
<b>Normal</b>	10 to 80 cm (3.9 to 31.5 inches)	3.2x	23.9x	16:9@30 fps
<b>Motion</b>				16:9@60 fps
<b>Wide Angle</b>				4:3@30 fps
<b>Microscope</b>	---	1x		16:9@30 fps
<b>Macro</b>	5 to 10 cm (2 to 3.9 inches)	2.8x		
<b>Infinity</b>	80 to ∞ cm (31.5 to ∞ inches)	9.7x		

\*1: These zoom magnifications are theoretical values.







The following options and consumables are available. Please purchase according to your application.







These optional items are current as of April 2023.

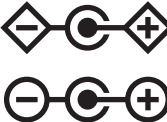

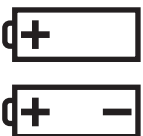





They are subject to change without notice.

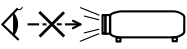

<b>Soft carrying case</b> ELPKS72	Use this case to carry the document camera.
--------------------------------------	---

The following table lists the meaning of the safety symbols labeled on the equipment.

No.	Symbol mark	Approved standards	Explanation
①		IEC60417 No.5007	"ON" (power) To indicate connection to the mains.
②		IEC60417 No.5008	"OFF" (power) To indicate disconnection from the mains.
③		IEC60417 No.5009	Stand-by To identify the switch or switch position by means of which part of the equipment is switched on in order to bring it into the stand-by condition.
④		ISO7000 No.0434B IEC3864-B3.1	Caution To identify general caution when using the product.
⑤		IEC60417 No.5041	Caution, hot surface To indicate that the marked item can be hot and should not be touched without taking care.
⑥		IEC60417 No.6042 ISO3864-B3.6	Caution, risk of electric shock To identify equipment that has risk of electric shock.
⑦		IEC60417 No.5957	For indoor use only To identify electrical equipment designed primarily for indoor use.
⑧		IEC60417 No.5926	Polarity of d.c. power connector To identify the positive and negative connections (the polarity) on a piece of equipment to which a d.c. power supply may be connected.

No.	Symbol mark	Approved standards	Explanation
⑨		IEC60417 No.5001B	Battery, general On battery powered equipment. To identify a device for instance a cover for the battery compartment, or the connector terminals.
⑩		IEC60417 No.5002	Positioning of cell To identify the battery holder itself and to identify the positioning of the cell(s) inside the battery holder.
⑪		IEC60417 No.5019	Protective earth To identify any terminal which is intended for connection to an external conductor for protection against electric shock in case of a fault, or the terminal of a protective earth electrode.
⑫		IEC60417 No.5017	Earth Indicates a grounding port when No.11 is not explicitly called for.
⑬		IEC60417 No.5032	Alternating current To indicate on the rating plate that the equipment is suitable for alternating current only; to identify relevant terminals.
⑭		IEC60417 No.5031	Direct current To indicate on the rating plate that the equipment is suitable for direct current only; to identify relevant terminals.
⑮		IEC60417 No.5172	Class II equipment To identify equipment meeting the safety requirements specified for Class II equipment according to IEC 61140.
⑯		ISO 3864	General prohibition To identify actions or operations that are prohibited.

No.	Symbol mark	Approved standards	Explanation
17		ISO 3864	Contact prohibition To indicate injury that could occur due to touching a specific part of the equipment.
18		---	Never look into the optical lens while the projector is on.
19		---	To indicate that the marked item don't place anything on projector.
20		ISO3864 IEC60825-1	Caution, laser radiation To indicate the equipment has a laser radiation part.
21		ISO 3864	Disassembly prohibition To indicate a risk of injury, such as electric shock, if the equipment is disassembled.
22		IEC60417 No.5266	Stand-by or preparatory state for a part of equipment To indicate the stand-by or preparatory state for a part of equipment.
23		ISO3864 IEC60417 No.5057	Caution, moving parts To indicate the instructional safeguard to keep away from moving parts.
24		IEC60417 No.6056	Caution, moving fan blades To indicate the instructional safeguard to keep away from moving fan blades.
25		IEC60417 No.6043	Caution, sharp edges To indicate that the marked item contains sharp edges and should not be touched without taking care.
26		---	Never look into the optical lens while the projector is on.

No.	Symbol mark	Approved standards	Explanation
27		ISO7010 No.W027 ISO 3864	Warning; Optical radiation To warn of optical radiation. Taking care to avoid injury to eyes and skin when in the vicinity of optical radiation.
28		IEC60417 No.5109	Not to be used in residential areas To identify electrical equipment which is not suitable for a residential area (e.g. equipment which produces radio interference when in operation).
29		---	Indicates that you should not look into the lens while the LED is on.

## FCC Compliance Statement

**Supplier's DECLARATION of CONFORMITY**

According to 47CFR, Part 2 and 15

Class B Personal Computers and Peripherals; and/or  
CPU Boards and Power Supplies used with Class B Personal Computers

We: Epson America, Inc.  
 Located at: 3131 Katella Avenue, Los Alamitos, CA  
 Tel: 562 -981-3840

Declare under sole responsibility that the product identified herein, complies with 47CFR Part 2 and 15 of the FCC rules as a Class B digital device. Each product marketed, is identical to the representative unit tested and found to be compliant with the standards. Records maintained continue to reflect the equipment being produced can be expected to be within the variation accepted, due to quantity production and testing on a statistical basis as required by 47CFR §2.906. Operation is subject to the following two conditions: (1) this device may not cause harmful interference, and (2) this device must accept any interface received, including interference that may cause undesired operation.

Trade Name: EPSON  
 Type of Product: Document Camera  
 Model: ELPDC30

Options:

Product name	Model
Remote controller	1913835xx (x = 0-9)

**Supplier's DECLARATION of CONFORMITY**

According to 47CFR, Part 2 and 15  
Class B external switching power supplies

We: FSP GROUP INC.  
Located at: TBD  
Tel: TBD

Declare under sole responsibility that the product identified herein, complies with 47CFR Part 2 and 15 of the FCC rules as a Class B digital device. Each product marketed, is identical to the representative unit tested and found to be compliant with the standards. Records maintained continue to reflect the equipment being produced can be expected to be within the variation accepted, due to quantity production and testing on a statistical basis as required by 47CFR §2.906. Operation is subject to the following two conditions: (1) this device may not cause harmful interference, and (2) this device must accept any interference received, including interference that may cause undesired operation.

Trade Name: FSP, PROTEK, AXIS  
Type of Product: Switching Power Adapter  
Model: FSP015-DPAN3  
Options: None

All rights reserved. No part of this publication may be reproduced, stored in a retrieval system, or transmitted in any form or by any means, electronic, mechanical, photocopying, recording, or otherwise, without the prior written permission of Seiko Epson Corporation. No patent liability is assumed with respect to the use of the information contained herein. Neither is any liability assumed for damages resulting from the use of the information contained herein.

Neither Seiko Epson Corporation nor its affiliates shall be liable to the purchaser of this product or third parties for damages, losses, costs, or expenses incurred by the purchaser or third parties as a result of: accident, misuse, or abuse of this product or unauthorized modifications, repairs, or alterations to this product, or (excluding the U.S.) failure to strictly comply with Seiko Epson Corporation's operating and maintenance instructions.

Seiko Epson Corporation shall not be liable against any damages or problems arising from the use of any options or any consumable products other than those designated as Original Epson Products or Epson Approved Products by Seiko Epson Corporation.

The contents of this guide may be changed or updated without further notice.

Illustrations in this guide and the actual projector may differ.

This information is subject to change without notice.

© SEIKO EPSON CORPORATION 2023. All rights reserved.

2023.04 414411400 EN

---

## Trademarks

EPSON is a registered trademark of Seiko Epson Corporation.

HDMI, the HDMI logo, and High-Definition Multimedia Interface are trademarks or registered trademarks of HDMI Licensing Administrator,

Inc.  HIGH DEFINITION MULTIMEDIA INTERFACE

Wi-Fi® and Miracast® are registered trademarks of the Wi-Fi Alliance®.

Other product names used herein are for identification purposes only and may be trademarks of their respective owners. Epson disclaims any and all rights in those marks.