

EPSON



Google TV

User's Guide

Home Projector

EF-21 Series

EF-22 Series

Notations Used in This Guide **5**

Using the Manual to Search for Information 7

- Searching by Keyword 7
- Jumping Directly from Bookmarks 7
- Printing Only the Pages You Need 7

Getting the Latest Version of the Documents 8

Introduction to Your Projector **9**

Projector Parts and Functions 10

- Projector Parts - Front/Side 10
- Projector Parts - Rear/Side 11
- Projector Parts - Base 12
- Projector Parts - Remote Control 14

Setting Up the Projector **16**

Projector Placement 17

- Projector Setup and Installation Options 19
- Precautions on Installation 19
- Projection Distance 20
- Mounting the Projector on a Tripod or Projector Stand 21

Projector Connections 23

- Connecting to an HDMI Video Source 23
- Connecting to a Computer for HDMI Video and Audio 23
- Connecting to External USB Devices 24
- Connecting Headphones 25
- Connecting to an ARC Compatible AV System 25

Installing Batteries in the Remote Control 26

- Remote Control Operation 26

Setting Up the Projector OS 28

- Projector's Home Screen 28

About Epson Projector Update 30

- Installing Epson Projector Update 30

Using Basic Projector Features **31**

Turning On the Projector (EF-21) 32

Turning On the Projector (EF-22) 33

- AC Adapter Safety Instructions 33

Turning Off the Projector 35

Projection Modes 36

- Changing the Projection Mode Using the Menus 36

Adjusting the Image Height (EF-21) 37

Adjusting the Position of the Image (EF-22) 38

Image Shape 39

- Correcting the Image Shape and Focus Automatically 39
- Adjusting the Size of the Image 40
- Adjusting the Position of the Image 41
- Automatically Correcting the Image Shape with Fit to Screen 41
- Correcting the Image Shape Manually 42

Focusing the Image Using the Projector Menus 44

Selecting an Image Source 45

Image Aspect Ratio 46

- Changing the Image Aspect Ratio 46
- Available Image Aspect Ratios 46

Adjusting Image Quality (Color Mode) 47

- Changing the Color Mode 47
- Available Color Modes 47

Adjusting Image Quality in Detail 48

- Turning On Automatic Luminance Adjustment 49**
- Adjusting the Light Source Brightness 50**
- Controlling the Volume with the Volume Buttons 51**
- Changing the Sound Mode 52**
 - Available Sound Modes 52

Adjusting Projector Features 53

- Using the Projector as a Bluetooth Speaker 54**
 - Bluetooth Specifications 54
- Shutting Off the Image Temporarily 56**
- Using Google Cast™ 57**
- HDMI CEC Features 58**
 - Operating Connected Devices Using the HDMI CEC Features 58
- Installing a Security Cable 59**
- Updating Projector Firmware Using Epson Projector Update 60**
- Initializing the Projector 61**

Adjusting the Menu Settings 62

- Using the Projector's Menus 63**
- Projector Feature Settings - Inputs Menu 64**
- Projector Feature Settings - Projector Menu 65**
- Image Quality Settings - Display & Sound Menu 67**
- Other Menus 68**
 - Network & Internet Menu 68
 - Accounts & sign-in Menu 68
 - Privacy Menu 68

- Apps Menu 68
- System Menu 68
- Remotes & Accessories Menu 69
- Help & Feedback Menu 69

Maintaining the Projector 70

- Projector Maintenance 71**
- Cleaning the Lens 72**
- Cleaning the Projector Case 73**
- Air Filter and Vent Maintenance 74**
 - Cleaning the Air Filters and Intake Vents 74

Solving Problems 76

- Projection Problems 77**
- Projector Indicator Status 78**
- Solving Projector Power-On or Power-Off Problems 80**
 - Solving Projector Power Problems 80
 - Solving Projector Shutdown Problems 80
- Solving Image Problems 81**
 - Solving Missing Image Problems 81
 - Adjusting an Image that is not Rectangular 81
 - Adjusting a Fuzzy or Blurry Image 82
 - Fixing Partial Image Problems 83
 - Adjusting an Image that Contains Noise or Static 83
 - Adjusting an Image with Incorrect Brightness or Colors 83
 - Adjusting an Upside-down Image 84
 - Solving Auto Correction Problems 84
- Solving Sound Problems 85**
 - Solving Missing or Low Audio Problems 85
 - Solving Bluetooth Speaker Mode Problems 85

Solving Remote Control Operation Problems 87
Solving HDMI CEC Problems 88
Solving Wi-Fi Network Problems 89
Solving Projector's OS Problems 90

Appendix 91



Optional Accessories and Replacement Parts 92
Mounts 92
Screen Size and Projection Distance 93
Supported Monitor Display Resolutions 95
Projector Specifications 96
AC Adapter Specifications (EF-22) 97
Connector Specifications 97
External Dimensions 98
List of Safety Symbols and Instructions 100
Laser Safety Information 102
Laser Warning Labels 102
Glossary 106
Notices 107
FCC Compliance Statement 107
Indication of the manufacturer and the importer in accordance with requirements of EU directive 108
Indication of the manufacturer and the importer in accordance with requirements of United Kingdom directive 108
Restriction of Use 108
Trademarks 109
Copyright Notice 109
Copyright Attribution 109

Notations Used in This Guide







Safety Symbols

The projector and its manuals use graphical symbols and labels to indicate content that tells you how to use the projector safely.

Read and carefully follow the instructions that are marked with these symbols and labels to avoid injury to persons or damage to property.

 Warning	This symbol indicates information that, if ignored, could possibly result in personal injury or even death.
 Caution	This symbol indicates information that, if ignored, could possibly result in personal injury or physical damage due to incorrect handling.

General Information Notations

Attention	This label indicates procedures that may result in damage or injury if sufficient care is not taken.
	This label indicates additional information that may be useful to know.
 button	Indicates the buttons on the remote control or the control panel. Example:  button
Menu/Setting name	Indicates projector menu and setting names. Example: Select the Projector menu.  Projector > Image Correction > Auto Keystone Correction
	This label indicates links to the related pages.
	This label indicates the projector's current menu level.

▶ Related Links

- "Using the Manual to Search for Information" [p.7](#)

- "Getting the Latest Version of the Documents" [p.8](#)

The PDF manual allows you to search for information you are looking for by keyword, or jump directly to specific sections using the bookmarks. You can also print only the pages you need. This section explains how to use a PDF manual that has been opened in Adobe Reader X on your computer.

► Related Links

- "Searching by Keyword" [p.7](#)
- "Jumping Directly from Bookmarks" [p.7](#)
- "Printing Only the Pages You Need" [p.7](#)

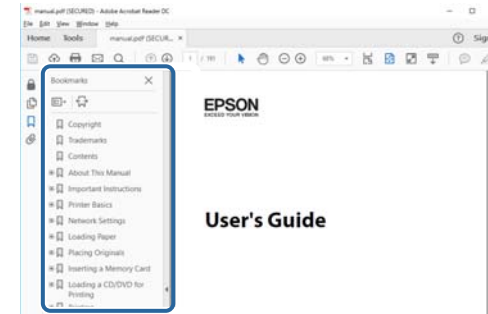

Searching by Keyword

Click **Edit > Advanced Search**. Enter the keyword (text) for information you want to find in the search window, and then click **Search**. Hits are displayed as a list. Click one of the displayed hits to jump to that page.

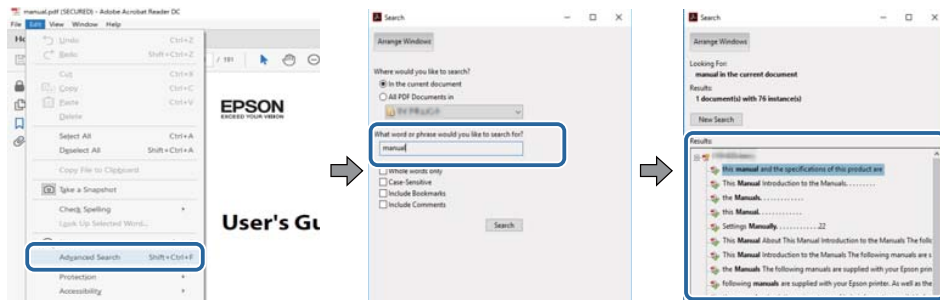

Jumping Directly from Bookmarks

Click a title to jump to that page. Click + or > to view the lower level titles in that section. To return to the previous page, perform the following operation on your keyboard.

- Windows: Hold down **Alt**, and then press **←**.
- Mac OS: Hold down the command key, and then press **←**.

Printing Only the Pages You Need

You can extract and print only the pages you need. Click **Print** in the **File** menu, and then specify the pages you want to print in **Pages** in **Pages to Print**.

- To specify a series of pages, enter a hyphen between the start page and the end page.
Example: 20-25
- To specify pages that are not in series, divide the pages with commas.
Example: 5, 10, 15

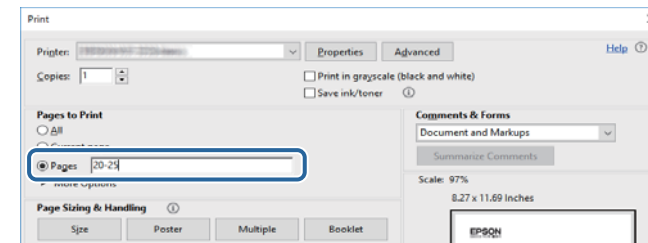

You can get the latest version of the manuals and specifications on the Epson Web site.

Visit epson.sn, and enter your model name.

Introduction to Your Projector

See these sections to learn more about your projector.

▶ **Related Links**

- "Projector Parts and Functions" [p.10](#)

The following sections explain the projector parts and their functions.
 All of the features in this guide are explained using illustrations of EF-21 unless otherwise mentioned.

► **Related Links**

- "Projector Parts - Front/Side" [p.10](#)
- "Projector Parts - Rear/Side" [p.11](#)
- "Projector Parts - Base" [p.12](#)
- "Projector Parts - Remote Control" [p.14](#)

Projector Parts - Front/Side

EF-21

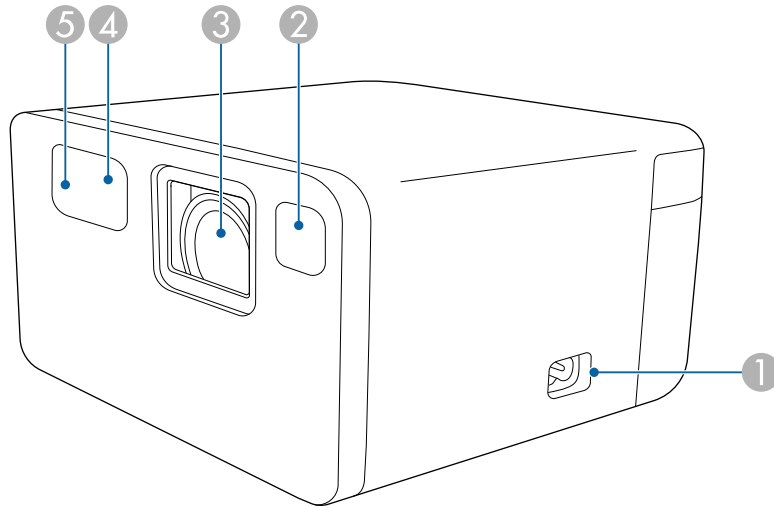

EF-22 (model with stand)

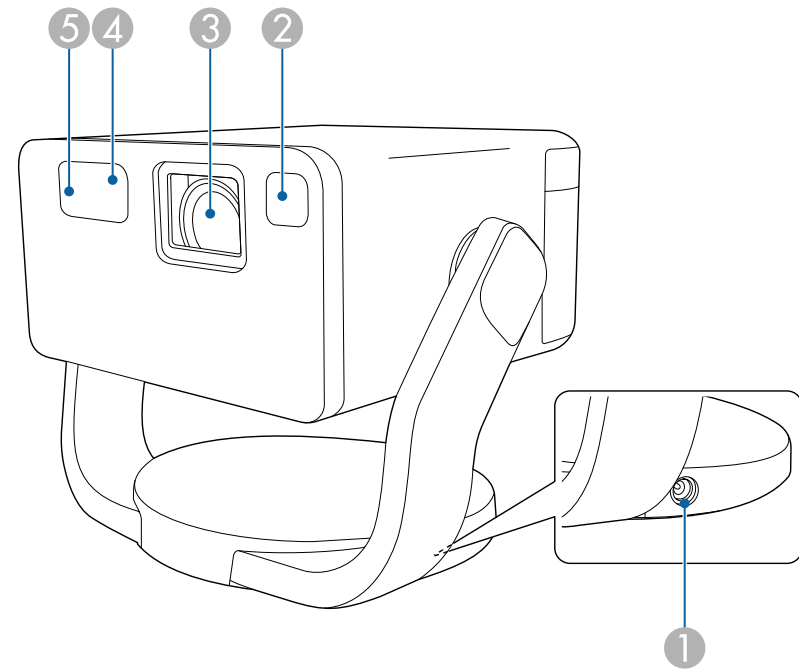

Name		Function
①	Power inlet	Connects the power cord to the projector (EF-21).
①	AC adapter port	Connects the AC adapter (EF-22).
②	Sensor	Detects obstacles that are interfering with the projection area and automatically adjusts the shape and focus of the projected image. It also reduces the brightness of the light source to minimize glare (Smart eye protection).
③	Lens	Images are projected from here.
④	Remote receiver	Receives signals from the remote control.
⑤	Camera	Automatically adjusts the shape and focus of the projected image.

► **Related Links**

- "Remote Control Operation" [p.26](#)

Projector Parts - Rear/Side

EF-21

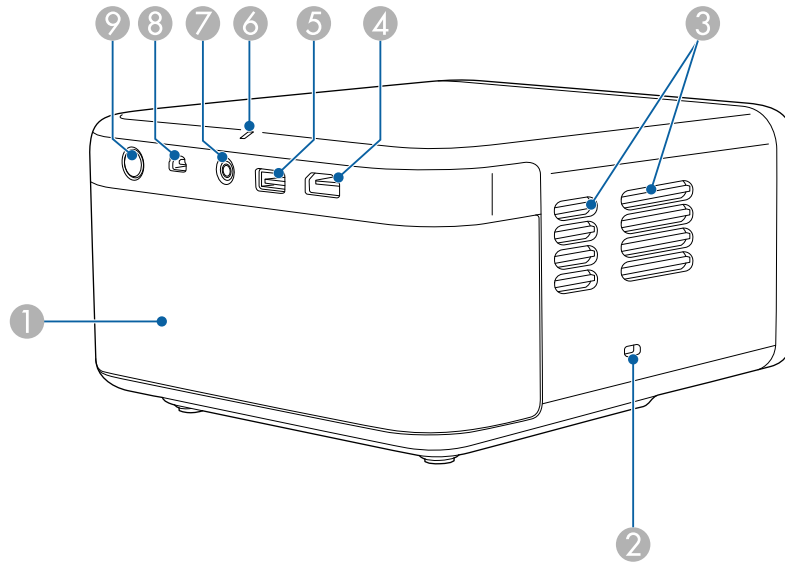

EF-22 (model with stand)

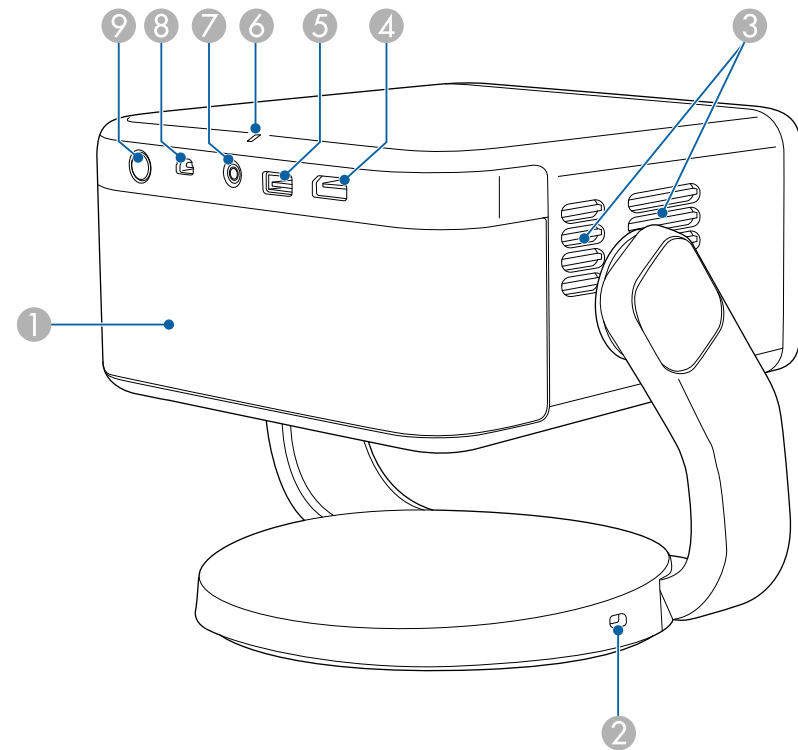

Name	Function
① Speaker	Outputs audio.
② Security slot	You can install the security cable (security lock) on the projector to deter theft.

Name	Function
③ Air exhaust vents	Exhaust vents for air used to cool the projector internally. <div style="border: 1px solid black; padding: 5px; background-color: #fff9c4;"> <p>⚠ Caution</p> <p>While projecting, do not put your face or hands near the air exhaust vent, and do not place objects that may become warped or damaged by heat near the vent. Hot air from the air exhaust vent could cause burns, warping, or accidents to occur.</p> </div>
④ HDMI (ARC) port	Inputs video signals from HDMI compatible video equipment and computers. This projector is compatible with HDCP 2.3. This port is compatible with HDMI ARC.
⑤ USB-A port	Connects a commercially available USB device such as a webcam, external HDD, or keyboard. <div style="border: 1px solid black; padding: 5px; background-color: #fff9c4;"> <p> This port is not guaranteed to operate for all devices that support USB.</p> </div>
⑥ Status indicator	Indicates the projector's status.
⑦ Audio Out port	Outputs audio from the current input source to headphones.
⑧ Service port	This port is not normally used.
⑨ Power button	Turns the projector on or off.

Projector Parts - Base

EF-21

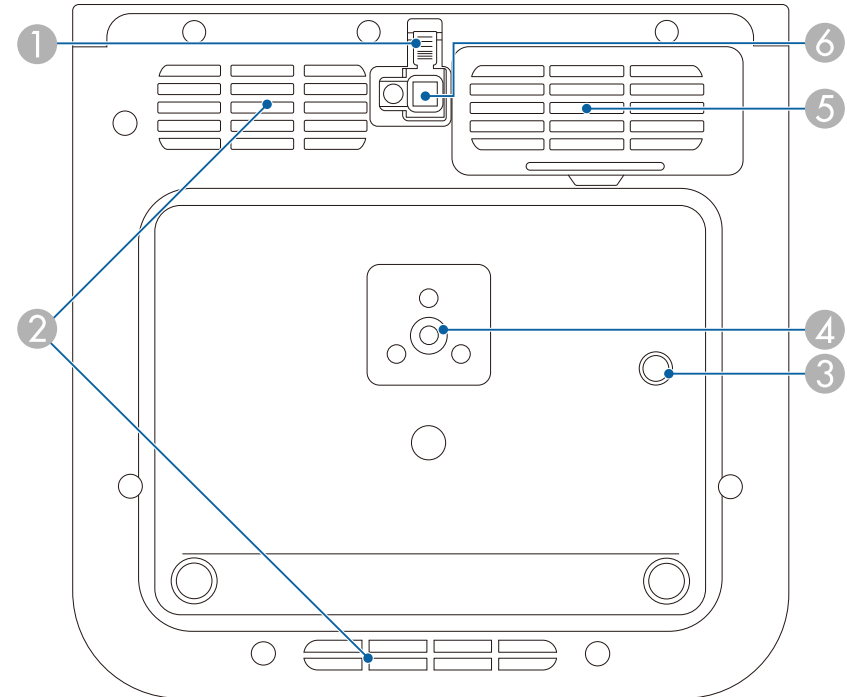

EF-22 (model with stand)

► Related Links

- "Projector Connections" [p.23](#)
- "Installing a Security Cable" [p.59](#)
- "Projector Indicator Status" [p.78](#)

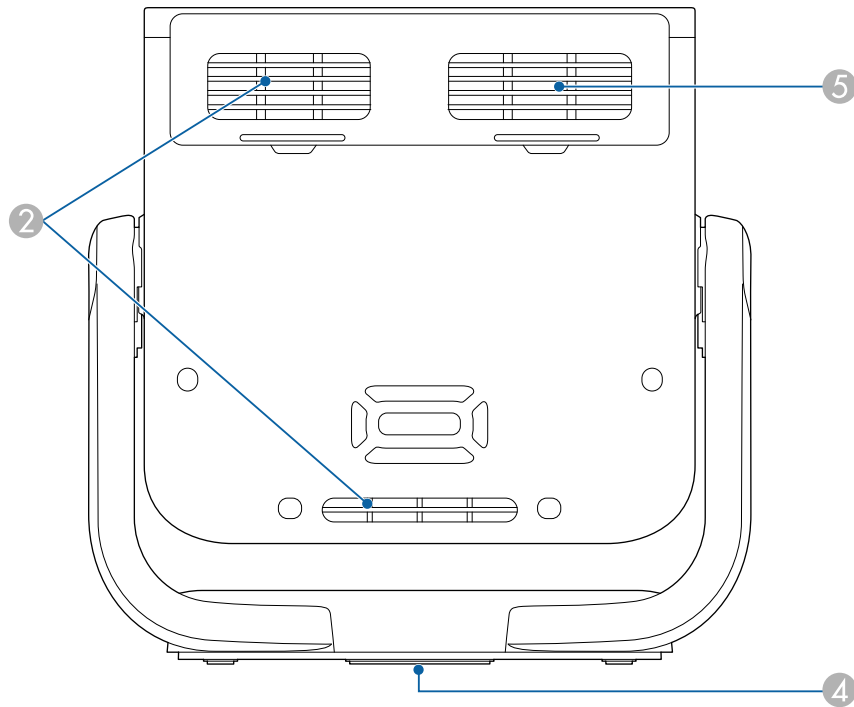

Name	Function
6 Front adjustable foot	When setup on a surface such as a desk, extend the foot to adjust the position of the image (EF-21).







►► **Related Links**

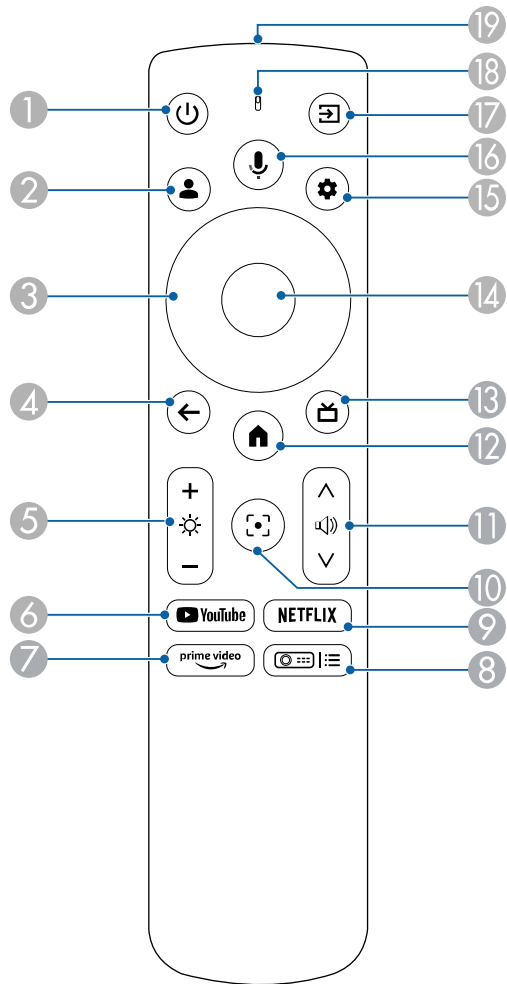



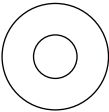

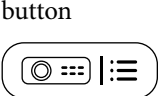

- "Mounting the Projector on a Tripod or Projector Stand" [p.21](#)
- "Adjusting the Image Height (EF-21)" [p.37](#)
- "Air Filter and Vent Maintenance" [p.74](#)

Name	Function
1 Foot release lever	Press the foot release lever to extend and retract the front adjustable foot (EF-21).
2 Air intake vent	Takes in air to cool the projector internally.
3 Security cable attachment point	Attach the optional safety wire here to prevent the projector from falling from the ceiling or wall (EF-21).
4 Mounting hole for tripod	Use when mounting the projector on a commercially available tripod. For the EF-22, this hole is located at the center of the bottom of the stand.
5 Air intake vent (air filter)	Takes in air to cool the projector internally.

Projector Parts - Remote Control



Name	Function
① Power button 	Turns the projector on or off.
② User Profile button 	Displays the user profile.
③ Arrow buttons 	Selects items on the home screen to play online content. Selects menu items while displaying the projector's menu.
④ Esc button 	Stops the current function. Moves back to the previous menu level while displaying the projector's menu.
⑤ Brightness button 	Lightens or darkens the projected image.
⑥ YouTube button 	Starts the YouTube application.
⑦ Prime Video button 	Starts the Amazon Prime Video application.
⑧ Projector menu button 	Displays the Projector menu screen.

Name	Function
9 Netflix button 	Starts the Netflix application.
10 Focus button 	Displays the focus adjustment screen. Press the up and down arrow buttons to adjust the focus setting. Hold down this button to automatically correct the focus of the projected image.
11 Volume up/down buttons 	Adjusts the volume for the speaker and headphones.
12 Home button 	Displays the home screen.
13 HDMI button 	Switches to the HDMI source.
14 [Enter] button 	Enters the current selection and moves to the next level while displaying the projector's menu.
15 Settings button 	Opens the dashboard.
16 Google Assistant button 	Press the Google Assistant button on the remote, or say, "Hey Google" to get started. <div style="border: 1px solid gray; padding: 5px; margin-top: 10px;">  <p>Google Assistant is not available in certain languages and countries. Availability of services varies by country and language.</p> </div>

Name	Function
17 Source Search button 	Displays a list of available input sources.
18 Indicator/Microphone 	Turns on when outputting signals from the remote control. Detects audio when you press the Google Assistant button.
19 Remote control light emitting area 	Outputs remote control signals.

►► **Related Links**

- "Turning On the Projector (EF-21)" [p.32](#)
- "Turning On the Projector (EF-22)" [p.33](#)
- "Adjusting the Light Source Brightness" [p.50](#)
- "Controlling the Volume with the Volume Buttons" [p.51](#)
- "Focusing the Image Using the Projector Menus" [p.44](#)
- "Using the Projector's Menus" [p.63](#)
- "Selecting an Image Source" [p.45](#)

Setting Up the Projector

Follow the instructions in these sections to set up your projector.

▶ Related Links

- "Projector Placement" [p.17](#)
- "Projector Connections" [p.23](#)
- "Installing Batteries in the Remote Control" [p.26](#)
- "Setting Up the Projector OS" [p.28](#)
- "About Epson Projector Update" [p.30](#)

You can place the projector on almost any flat surface to project an image.

You can also mount the projector on a commercially available tripod or on a commercially available projector stand.

The projector can be installed at various angles. There is no vertical or horizontal limit to how the projector can be installed.

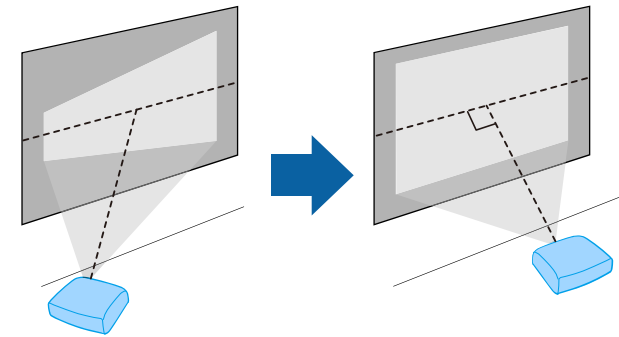
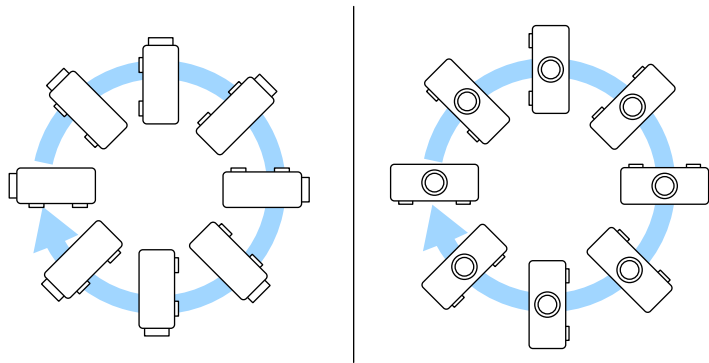

If you cannot install the projector squarely facing the screen, correct any resulting keystone distortion using the projector controls. For the best quality images, we recommend adjusting the installation position of the projector to achieve the correct image size and shape.

Note the following points when selecting a projector location:

- Place the projector on a sturdy, level surface or install it using a compatible mount.

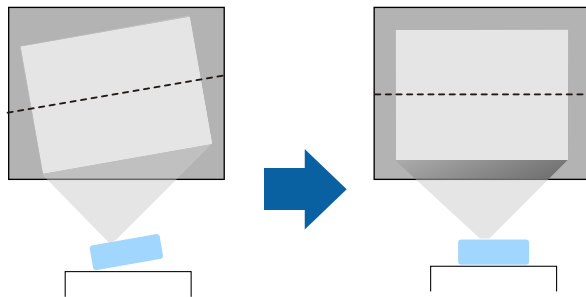

- Leave plenty of space around and under the projector for ventilation, and do not place it on top of or next to anything that could block the vents.
- Place the projector so it squarely faces the screen, not at an angle.

Warning

- You must install a ceiling mount when suspending the projector from a ceiling. If you do not install the projector correctly, it could fall and cause damage or injury.
- Do not use adhesives on the mounting hole to prevent the screws from loosening, or use lubricants, oils, or similar substances on the projector; the projector case may crack causing it to fall. This could cause serious injury to anyone under the ceiling mount and could damage the projector.
- Do not install the projector in a location subject to high levels of dust or humidity, or in a location subject to smoke or steam. Otherwise, it could cause a fire or electric shock to occur. The projector's case could also deteriorate and be damaged causing the projector to fall from the mount.

Examples of environments that could cause the projector to fall due to case deterioration

- Locations subject to excessive smoke or airborne oil particles, such as factories or kitchens
- Locations containing volatile solvents or chemicals, such as factories or laboratories
- Locations where the projector could be subjected to detergents or chemicals, such as factories or kitchens
- Locations in which aroma oils are often used, such as relaxation rooms
- Near devices that produce excessive smoke, airborne oil particles, or foam at events
- Locations near humidifiers

Warning

- Do not cover the projector's air intake or air exhaust vents. If the vents are covered, the internal temperature could rise and cause a fire.
- Do not use or store the projector in locations where it will be subject to dust or dirt. Otherwise, the quality of the projected image may decline, or the air filter may become clogged, resulting in a malfunction or fire.
- Do not install the projector on an unstable surface or in a location beyond the weight specifications of the projector. Otherwise, it could fall or topple causing an accident and injury.
- When installing the projector in a high position, take measures to prevent falling by using wires to ensure safety in an emergency, such as an earthquake, and to prevent accidents. If it is not installed correctly, it could fall causing an accident and injury.
- Do not install in locations where salt damage could occur, or in locations subject to corrosive gas such as sulphuric gas from hot springs. Otherwise, corrosion could cause the projector to fall. It could also cause the projector to malfunction.

Caution

When carrying the projector, be sure to hold the stand in both hands. Otherwise, the projector could fall causing damage or injury (EF-22).

▶▶ Related Links

- "Projector Setup and Installation Options" [p.19](#)
- "Projection Distance" [p.20](#)
- "Mounting the Projector on a Tripod or Projector Stand" [p.21](#)
- "Adjusting the Image Height (EF-21)" [p.37](#)
- "Adjusting the Position of the Image (EF-22)" [p.38](#)
- "Focusing the Image Using the Projector Menus" [p.44](#)
- "Image Shape" [p.39](#)
- "Focusing the Image Using the Projector Menus" [p.44](#)

Projector Setup and Installation Options

You can set up or install your projector in the following ways:

Make sure you select the correct **Projection Mode** option in the projector's menu according to the installation method being used.

Front/Rear

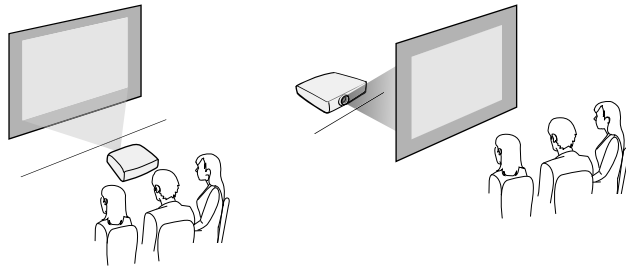

Front Ceiling/Rear Ceiling

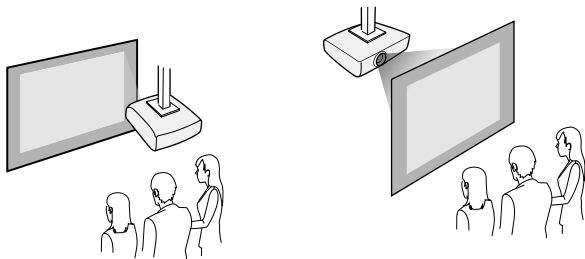

Projecting Images onto a Ceiling

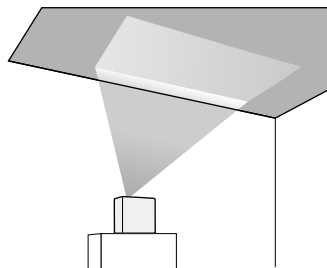

Caution

Do not cover the projector's lens. If the lens is covered, the internal temperature could rise and it could result in a malfunction.

Attention

- We recommend installing the projector on a protective mat to prevent the projector or the cloth covering the speaker from being damaged, or the color from staining unprotected surfaces (EF-21).
- The sound from the projector's speaker may be muffled (EF-21).
- If you tilt the projector toward the ceiling while connection cables are connected to the projector's ports, the cables and ports can be damaged. Disconnect the cables before tilting the projector (EF-22).

▶▶ **Related Links**

- "Precautions on Installation" [p.19](#)
- "Projection Modes" [p.36](#)

Precautions on Installation

Note the following precautions when installing the projector.

Installation space

Attention

Be sure to leave the following amount of space around the projector so as not to block the air exhaust and intake vents.

EF-21

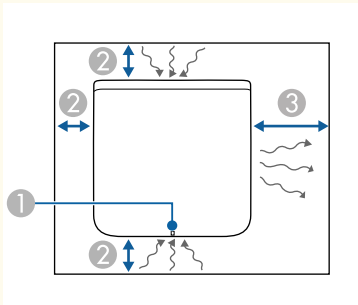

EF-22

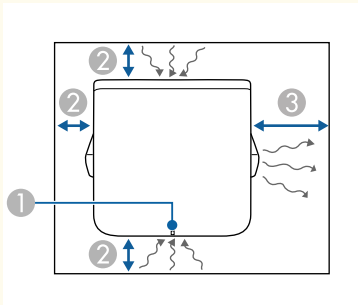

- ① Status indicator
- ② 10 cm
- ③ 30 cm

⚠ Caution

Install the supplied AC adapter more than 30 cm away from the projector. If the temperature of the AC adapter rises due to heat from the projector, the projector may not operate properly (EF-22).

Projection Distance

The distance at which you place the projector from the screen determines the approximate size of the image. The image size increases the farther the projector is from the screen, but can vary depending on the aspect ratio and other settings.

See the Appendix for details about how far to place the projector from the screen based on the size of the projected image.



When correcting keystone distortion, your image is slightly smaller.

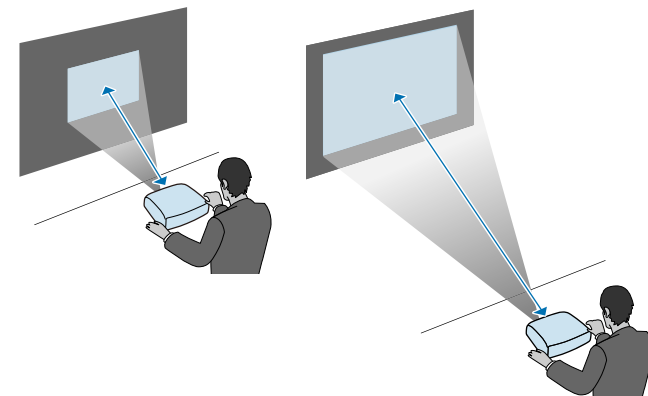

▶▶ Related Links

- "Screen Size and Projection Distance" [p.93](#)

Mounting the Projector on a Tripod or Projector Stand

You can mount the projector on a commercially available tripod or projector stand.



- You can mount the projector on a tripod that uses 1/4-20UNC size fixing screws.
- When installing the projector in a high place, be sure to attach the optional security wire set (ELPWR01) for safety purposes.

1 Turn the projector upside down.

2 When installing the projector in a high place, attach the optional security wire set (ELPWR01) to the security cable attachment point.

EF-21

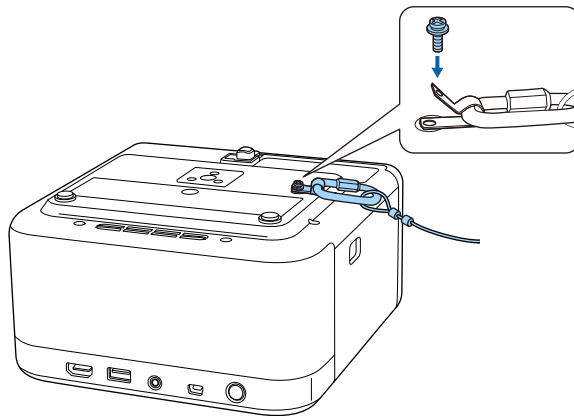

EF-22

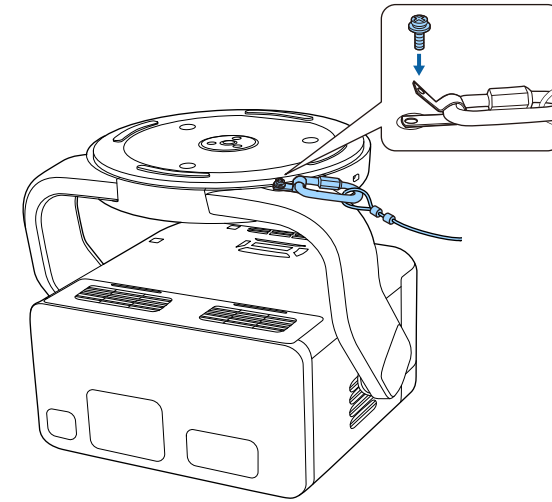

3 Mount the projector on a tripod or a projector stand. For details, see the documentation supplied with the tripod or projector stand.

Warning

When mounting the projector on the tripod, note the following points:

- Use a tripod that is strong enough to support the weight of the projector.
- Securely tighten the tripod's screw into the projector's mounting hole. If the screw loosens, the projector could fall or topple causing an accident and injury.
- Do not carry the projector while it is mounted on a tripod. Doing so will put too much pressure on the tripod fixing point and the projector could fall or topple causing an accident and injury.
- Place the tripod on a flat and stable surface. Otherwise, the tripod could topple causing an accident and injury.
- For details on how to use the tripod, see the documentation supplied with the tripod.



When installing the projector in a high place such as a ceiling, make sure you hook the carabiner of the optional security wire set (ELPWR01) to a point that is strong enough to hold the weight of the projector and the mounting hardware.

See these sections to connect the projector to a variety of projection sources.

Attention

- Check the shape and orientation of the connectors on any cable you plan to connect. Do not force a connector into a port if it does not fit. The device or your projector could be damaged or could malfunction.
- Make sure you connect the projector and video devices first, and then connect the power cord to the projector's power inlet and plug it into an electrical outlet.
- If you tilt the projector toward the ceiling while connection cables are connected to the projector's ports, the cables and ports can be damaged. Disconnect the cables before tilting the projector (EF-22).

▶ Related Links

- ["Connecting to an HDMI Video Source" p.23](#)
- ["Connecting to a Computer for HDMI Video and Audio" p.23](#)
- ["Connecting to External USB Devices" p.24](#)
- ["Connecting Headphones" p.25](#)
- ["Connecting to an ARC Compatible AV System" p.25](#)

Connecting to an HDMI Video Source

If your video source has an HDMI port, you can connect it to the projector using an HDMI cable.

Attention

Do not turn on the video source before connecting it to the projector. Doing so could damage the projector.



- If the port on the device you connect has an unusual shape, use the cable supplied with the device or an optional cable to connect to the projector.
- Some video devices are capable of outputting different types of signals. See your video device manual to confirm what type of signals can be output.

1 Connect the HDMI cable to your video source's HDMI output port.

2 Connect the other end to the projector's HDMI (ARC) port.

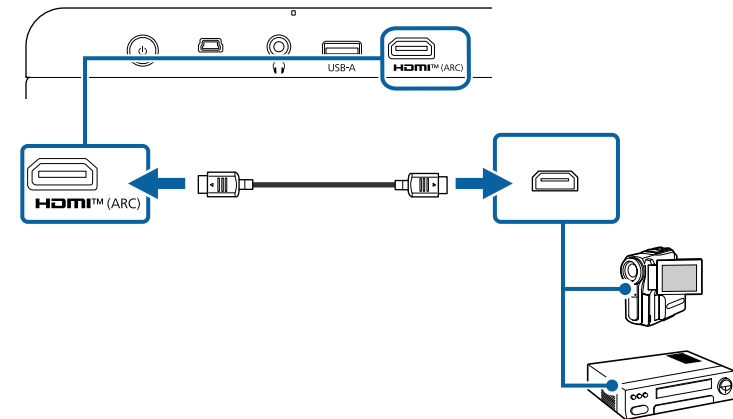

Connecting to a Computer for HDMI Video and Audio

If your computer has an HDMI port, you can connect it to the projector using an HDMI cable.

1 Connect the HDMI cable to your computer's HDMI output port.

2 Connect the other end to the projector's HDMI (ARC) port.

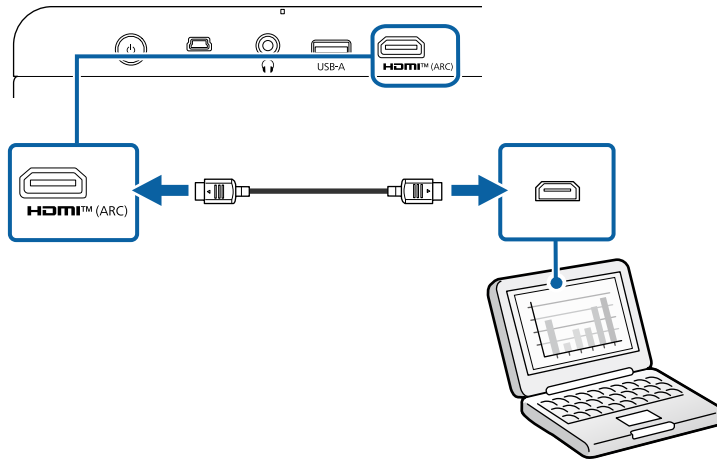

Connecting to External USB Devices

By connecting any of these devices to your projector, you can project images and other content or play audio without using a video device.

- Microphone
- USB flash drive
- Digital camera
- USB hard drive



- USB-A port is not guaranteed to operate all devices that support USB.
- You may need an app to project content from your USB device.
- USB hard drives must meet these requirements:
 - USB Mass Storage Class-compliant (not all USB Mass Storage Class devices are supported)
 - Formatted in FAT16/32
 - Self-powered by their own AC power supplies (bus-powered hard drives are not recommended)
 - Avoid using hard drives with multiple partitions

1 If your USB device came with a power adapter, plug the device into an electrical outlet.

2 Connect the USB device to the projector's USB-A port as shown.

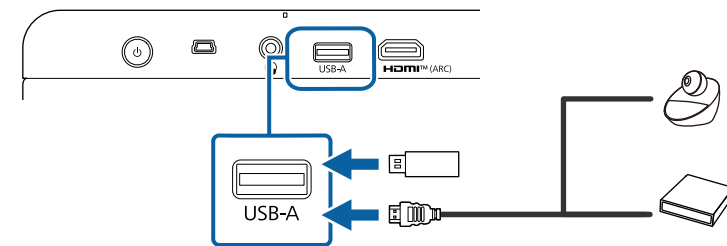

Attention

- Use the USB cable supplied with or specified for use with the device.
- If the USB cable is too long, the device may not operate correctly. We recommend using a USB cable that is three meters or less.
- If you use a USB hub, the device may not operate correctly. We recommend checking the operation in advance.

- 3 Connect the other end to your device, if necessary.

Connecting Headphones

You can connect headphones to the projector's Audio Out port. You can control the volume using the projector's remote control.

Attention

The projector's Audio Out port only supports 3-pin headphones. If you use any other headphones, audio may not be output normally.

- 1 Connect the stereo headphone's mini-jack cable to the projector's Audio Out port.

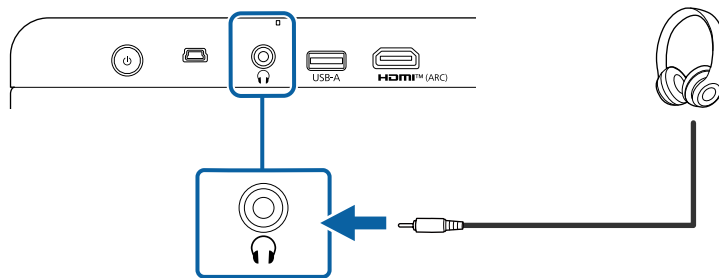

Caution

Do not start a playback at a high volume setting. Sudden loud noises may cause hearing loss.

Always lower the volume before powering off, so that you can power on and then gradually increase the volume.

Connecting to an ARC Compatible AV System

If your AV system has an HDMI port, you can connect it to the projector using an HDMI cable (ARC compatible) to output audio to the AV system.

- 1 Connect the HDMI cable to your AV system's HDMI output port (ARC compatible).
- 2 Connect the other end to the projector's HDMI (ARC) port.

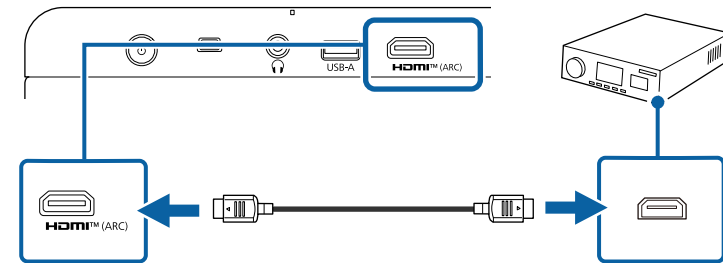

- To output audio, set **HDMI control** to **On** in the projector's menu.
☛ **Inputs > Inputs > HDMI control**
- If audio is not output properly, try changing **Auto** to **PCM** as the **Digital Output** setting in the projector's menu.
☛ **Display & Sound > Audio Output > Digital Output**
- When playing online content, audio is output in 2 ch (L-PCM).

The remote control uses the two AAA batteries that came with the projector.

Attention

Make sure you read the *Safety Instructions* before handling the batteries.

- 1 Remove the battery cover as shown.

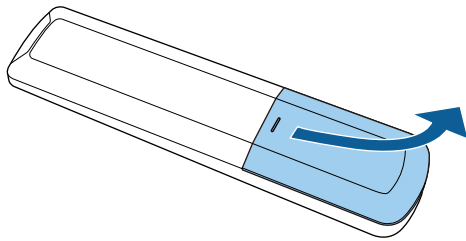

- 2 Remove the old batteries, if necessary.



Dispose of used batteries according to local regulations.

- 3 Insert the batteries with the + and - ends facing as shown.

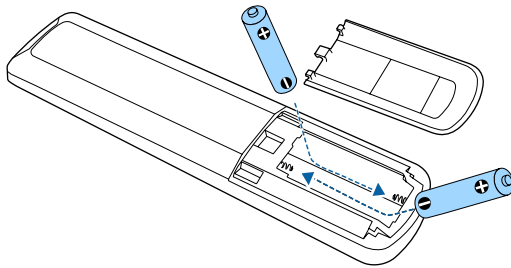

Warning

Check the positions of the (+) and (-) marks inside the battery holder to ensure the batteries are inserted the correct way. If the batteries are not used correctly, they could explode or leak causing a fire, injury, or damage to the product.

- 4 Replace the battery cover and press it down until it clicks into place.

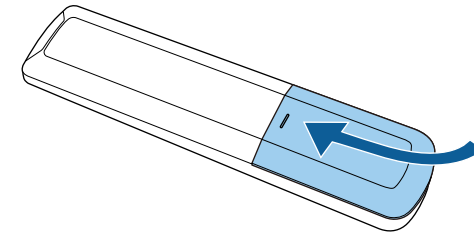

Related Links

- ["Remote Control Operation" p.26](#)

Remote Control Operation

The remote control lets you control the projector from almost anywhere in the room.

It is recommended that you aim the remote control at the projector's receivers within the distance and angles listed here.

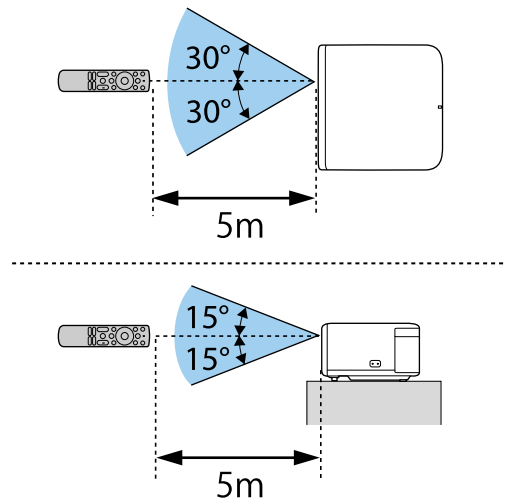



Avoid using the remote control in conditions with bright fluorescent lights or in direct sunlight, or the projector may not respond to commands. If you are not going to use the remote control for a long time, remove the batteries.

When you turn on the projector for the first time, you need to setup the projector's OS using the initial setup wizard.



You can change each of the settings even after completing the initial setup.

- 1** Turn on the projector.
- 2** When the pairing screen is displayed, hold down the  button and  button on the remote control at the same time to pair the remote control and the projector.

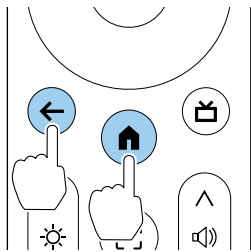

When pairing starts, the indicator on the remote control flashes.
When pairing is complete, the indicator turns off.

- 3** When the language selection screen is displayed, select the language you want to use, and then follow the on-screen instructions to select your country or region.

- 4** When the setting screen is displayed, follow the on-screen instructions to make the initial settings for the projector's OS.



We recommend logging in with your Google Account to make more detailed settings.

- 5** When the Wi-Fi setting screen is displayed, select the wireless network you want to use, and then follow the on-screen instructions to make necessary settings.
 - An internet connection is required to view online content. Make sure you can use the Wi-Fi service.
 - The customer is responsible are responsible for any communication charges incurred when downloading the app or watching online content.
- 6** Follow the on-screen instructions to make other necessary settings.
- 7** When you agree to the EPSON license terms, the initial setup wizard closes.

When you have finished the initial setup, the home screen is displayed.

▶▶ Related Links

- "Projector's Home Screen" [p.28](#)

Projector's Home Screen

When you turn on the projector or press the  button on the remote control, the home screen is displayed.

You can easily access recommended online content and applications from the home screen.

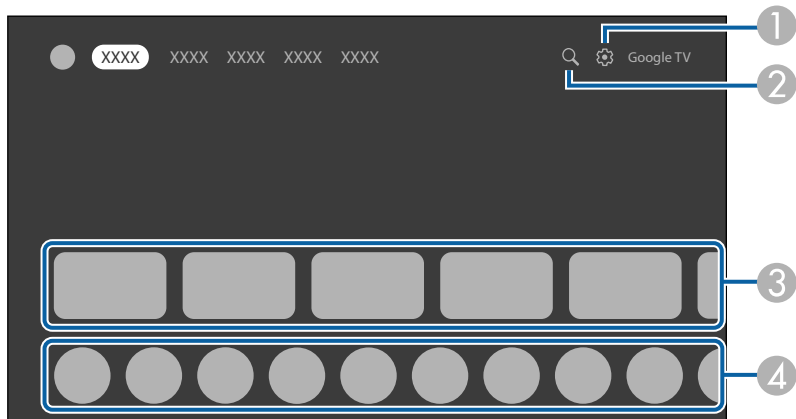

	Description
①	Displays the dashboard menu.
②	Searches for applications and online content.
③	Displays the online content recommended by the applications.
④	Displays the applications downloaded on the projector.



The content of the home screen may change depending on the version of the projector's OS.

The Epson Projector Update app allows you to check the projector firmware and update it to the latest version. This is necessary to keep the projector up to date. Install the app, launch the app, and check for the latest firmware.



The Epson Projector Update app is automatically installed by the projector's initial setting wizard. To install it automatically, make sure you log in with your Google Account, make the necessary Wi-Fi settings, and connect the projector to the internet.

▶ Related Links

- "Installing Epson Projector Update" [p.30](#)

Installing Epson Projector Update

Follow the steps below to manually install the Epson Projector Update app.

- 1** Select the search icon at the top right of the home screen.

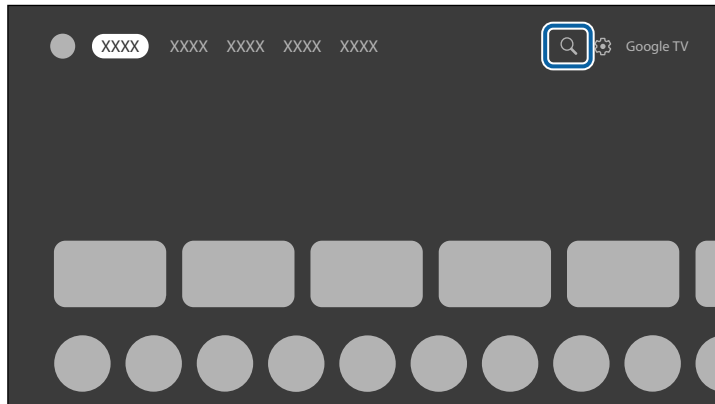

- 2** Search for "Epson Projector Update" to install it on the projector.



Epson Projector Update 

- 3** Start the Epson Projector Update app and confirm the latest projector firmware is installed on the projector.

▶ Related Links

- "Updating Projector Firmware Using Epson Projector Update" [p.60](#)

Using Basic Projector Features

Follow the instructions in these sections to use your projector's basic features.

► Related Links

- "Turning On the Projector (EF-21)" [p.32](#)
- "Turning On the Projector (EF-22)" [p.33](#)
- "Turning Off the Projector" [p.35](#)
- "Projection Modes" [p.36](#)
- "Adjusting the Image Height (EF-21)" [p.37](#)
- "Adjusting the Position of the Image (EF-22)" [p.38](#)
- "Image Shape" [p.39](#)
- "Focusing the Image Using the Projector Menus" [p.44](#)
- "Selecting an Image Source" [p.45](#)
- "Image Aspect Ratio" [p.46](#)
- "Adjusting Image Quality (Color Mode)" [p.47](#)
- "Adjusting Image Quality in Detail" [p.48](#)
- "Turning On Automatic Luminance Adjustment" [p.49](#)
- "Adjusting the Light Source Brightness" [p.50](#)
- "Controlling the Volume with the Volume Buttons" [p.51](#)
- "Changing the Sound Mode" [p.52](#)

When you connect the video equipment to the projector, turn on the video equipment you want to use after you turn on the projector.

- 1** Connect the power cord to the projector's power inlet and plug it into an electrical outlet.

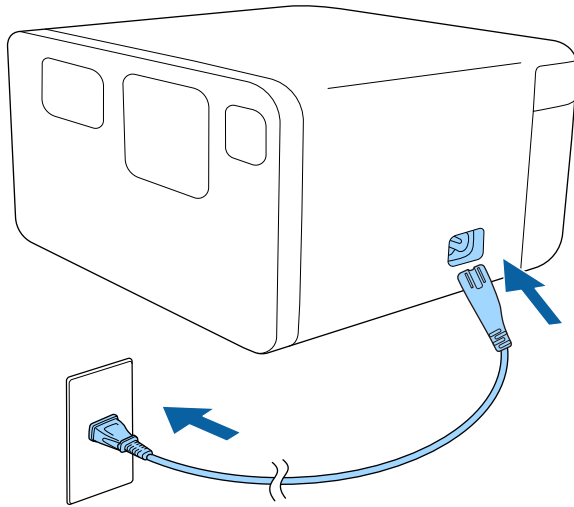

The status indicator flashes blue as the projector warms up.

When the indicator turns off, the projector enters standby mode. This indicates that the projector is receiving power, but is not yet turned on.

- 2** Press the power button on the projector or remote control to turn on the projector.

The status indicator turns blue and the light source turns on.

Auto focus and **Auto Keystone Correction** automatically correct the focus and any distortion of the projected image.

Warning

- Never look into the projector lens when the light source is on. This can damage your eyes and is especially dangerous for children.
- When turning on the projector at a distance using the remote control, make sure no one is looking into the lens.
- During projection, do not block the light from the projector with a book or other objects. If the light from the projector is blocked, the area on which the light shines becomes hot which could cause it to melt, burn, or start a fire. Also, the lens may get hot due to the reflected light which could cause the projector to malfunction. To stop projection, turn off the projector.
- Even when the projector is turned off, do not place any flammable objects such as a book or cloth in front of the lens. If the projector is unexpectedly turned on for some reason, it could result in a fire.

When you connect the video equipment to the projector, turn on the video equipment you want to use after you turn on the projector.

- 1** Connect the AC adapter to the projector's AC adapter port.
- 2** Connect the power cord to the AC adapter.
- 3** Plug the power cord into an electrical outlet.

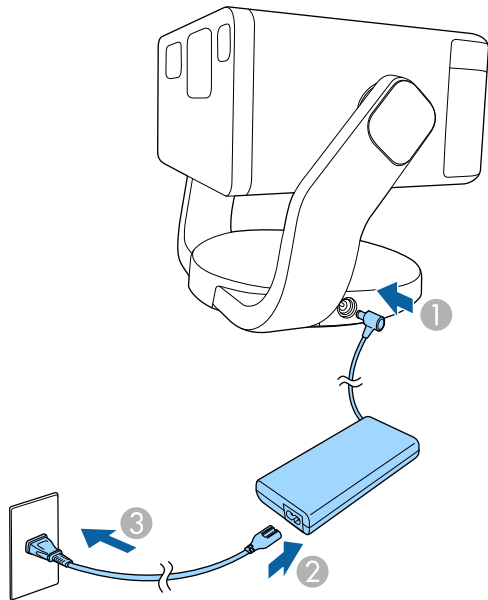

The status indicator flashes blue as the projector warms up.
When the indicator turns off, the projector enters standby mode. This indicates that the projector is receiving power, but is not yet turned on.

- 4** Press the power button on the projector or remote control to turn on the projector.
The status indicator turns blue and the light source turns on.

Auto focus and **Auto Keystone Correction** automatically correct the focus and any distortion of the projected image.

Warning

- Never look into the projector lens when the light source is on. This can damage your eyes and is especially dangerous for children.
- When turning on the projector at a distance using the remote control, make sure there is no one looking into the lens.
- During projection, do not block the light from the projector with a book or other objects. If the light from the projector is blocked, the area on which the light shines becomes hot which could cause it to melt, burn, or start a fire. Also, the lens may get hot due to the reflected light which could cause the projector to malfunction. To stop projection, turn off the projector.
- Even when the projector is turned off, do not place any flammable objects such as a book or cloth in front of the lens. If the projector is unexpectedly turned on for some reason, it could result in a fire.

▶▶ Related Links

- ["AC Adapter Safety Instructions" p.33](#)

AC Adapter Safety Instructions

Follow these safety instructions when using the supplied AC adapter.

Warning

- Under the following conditions, unplug the projector from the outlet and refer all repairs to qualified service personnel. Continuing to use under these conditions may result in fire or electric shock.
 - If smoke comes from the AC adapter.
 - If strange odors or strange noises come from the AC adapter.
 - If the AC adapter has been damaged.
 - If liquid or foreign objects get inside the AC adapter.

Warning

- Incorrect use of the AC adapter may cause malfunction, fire, or electric shock. Take the following precautions when using the AC adapter.
 - Do not use any AC adapter other than the one supplied with the projector.
 - The supplied AC adapter is designed specifically for this projector model. Do not use it with any other models.
 - Do not apply strong pressure or shocks to the AC adapter.
 - Do not hold the AC adapter with wet hands.
 - Do not install the AC adapter in a narrow space and do not cover it with cloth.
 - Do not touch the AC adapter for a long time while it is energized. It may cause a low-temperature burn.
 - Do not spray flammable gas such as insecticide on the AC adapter.
 - Do not put the AC adapter in a high-pressure container or a cooking appliance such as a microwave oven.
 - Do not place the AC adapter near the projector's air exhaust vent.
 - Do not wind the power cord around the AC adapter.

Turn off the projector after use.



Turn off this product when it is not in use to prolong the life of the projector. Light source life varies depending on the environmental conditions and usage. Brightness decreases over time.

- 1** Press the power button on the control panel or remote control.
The light source turns off, and the status indicator turns off.
- 2** To transport or store the projector, make sure the status indicator on the projector is off, and then unplug the power cord.

Depending on how you positioned the projector, you may need to change the projection mode so your images project correctly.



- **Front** lets you project from in front of the screen.
- **Front Ceiling** flips the image over top-to-bottom to project upside-down from a ceiling.
- **Rear** flips the image horizontally to project from behind a translucent screen.
- **Rear Ceiling** flips the image over top-to-bottom and horizontally to project from a ceiling and behind a translucent screen.

▶ Related Links

- ["Changing the Projection Mode Using the Menus" p.36](#)
- ["Projector Setup and Installation Options" p.19](#)

Changing the Projection Mode Using the Menus

You can change the projection mode to flip the image over top-to-bottom using the projector menus.

- 1** Turn on the projector and display an image.
- 2** Press the  button on the remote control.
- 3** Select the menus in the following order:
 - ☛ **Advanced Settings > Projection Mode**
- 4** Select a projection mode and press [Enter].
- 5** Press  to exit the menus.

If you are projecting from a table or other flat surface and the image is too high or low, you can adjust the image height using the projector's adjustable foot.

The larger the angle of tilt, the harder it becomes to focus. Locate the projector so that it only needs to be tilted at a small angle.

- 1** Turn on the projector and display an image.
- 2** Press the foot release lever to extend and retract the front adjustable foot.

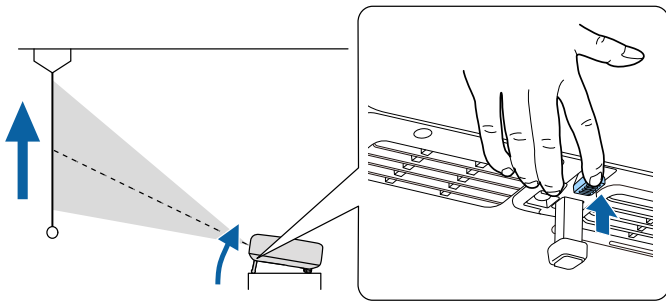

The foot extends from the projector.

You can adjust the position up to 9 degrees.

- 3** Release the lever to lock the foot.

If the projected image is unevenly rectangular, you need to adjust the image shape.

► Related Links

- "Image Shape" [p.39](#)

If you are projecting from a table or other flat surface, you can adjust the image position by tilting or moving the projector on the stand.

The larger the angle of tilt, the harder it becomes to focus. Locate the projector so that it only needs to be tilted at a small angle.

1 Turn on the projector and display an image.

2 Adjust the image height by tilting the projector up or down.

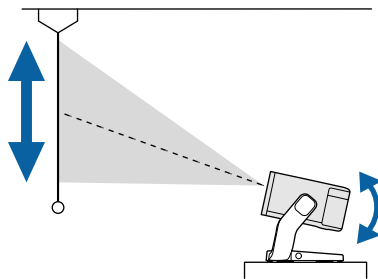

Attention

- You can adjust the position from -30 to +120 degrees vertically.
- Do not tilt the projector up or down beyond its range of movement. Doing so may cause a malfunction.

3 To adjust the horizontal position of the projected image, turn the projector stand left or right as shown below.

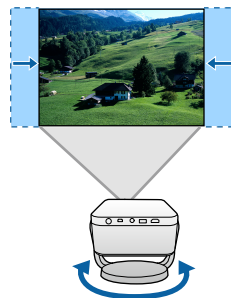

Attention

- Turn the projector stand slowly. Turning it with too much force may cause a malfunction.
- Do not turn the projector stand left or right beyond its range of movement. Doing so may cause a malfunction.
- Do not turn the projector stand by holding the cables connected to the projector's ports. Doing so may damage the cables or ports.

If the projected image is unevenly rectangular, you need to adjust the image shape.

► Related Links

- "Image Shape" [p.39](#)

You can project an even, rectangular image by placing the projector directly in front of the center of the screen and keeping it level. If you place the projector at an angle to the screen, or tilt it up or down, or off to the side, you may need to correct the image shape.

After correction, your image is slightly smaller.

For the best quality images, we recommend adjusting the installation position of the projector to achieve the correct image size and shape.

► Related Links

- "Correcting the Image Shape and Focus Automatically" [p.39](#)
- "Adjusting the Size of the Image" [p.40](#)
- "Adjusting the Position of the Image" [p.41](#)
- "Automatically Correcting the Image Shape with Fit to Screen" [p.41](#)
- "Correcting the Image Shape Manually" [p.42](#)

Correcting the Image Shape and Focus Automatically

The projector automatically corrects the focus and any keystone distortion of the projected image in the following situations:

- When you turn on the projector.
- When the projector is moved or tilted.

Focus and keystone distortion can be automatically corrected under the following conditions:

- When the size of the projected image (diagonal length) before correcting the focus and keystone distortion is from 30 to 100 inches.
- When the projection distance is about 0.7 to 2.2 m.
- When the installation angle of the projector toward the projection surface is within 20° right, left, up, or down.



- Focus and keystone distortion are corrected even if the size of the projected image exceeds 100 inches. However, the adjustment may fail depending on the installation angle of the projector, the brightness of the room, and the material of the projection surface. If necessary, adjust the keystone distortion and focus settings manually using the projector menu.
- When an image is being projected at an angle and has been reduced using the **Zoom** function, keystone distortion may not be corrected. If the correction fails, adjust the reduction ratio of the image so that it is closer to 100%.

☛ **Projector > Image Correction > Zoom & Shift > Zoom**



- Make sure that **Auto Focus at Startup** and **Auto Focus When Moving** are set to **On** in the projector's menu.
 - ☛ **Projector > Focus > Advanced > Auto Focus at Startup**
 - ☛ **Projector > Focus > Advanced > Auto Focus When Moving**
- If you set **Auto Focus at Startup** to **Off**, the focus of the projected image is not automatically corrected when you turn on the projector.
- If you set **Auto Focus When Moving** to **Off**, the focus of the projected image is not automatically corrected when the projector is moved or tilted.
- Make sure that **Auto Keystone Correction At Startup** and **Auto Keystone Correction on Movement** are set to **On** in the projector's menu.
 - ☛ **Projector > Image Correction > Advanced > Auto Keystone Correction At Startup**
 - ☛ **Projector > Image Correction > Advanced > Auto Keystone Correction on Movement**
- If you set **Auto Keystone Correction At Startup** to **Off**, **Auto Keystone Correction** does not automatically correct keystone distortion of the projected image when you turn on the projector.
- If you set **Auto Keystone Correction on Movement** to **Off**, **Auto Keystone Correction** does not automatically correct keystone distortion of the projected image when the projector is moved or tilted.



If you set **Avoid Obstacles** to **On**, the image is projected so that it avoids any obstacles in front of the projection surface. Your image is slightly smaller.

☛ **Projector > Image Correction > Advanced > Avoid Obstacles**

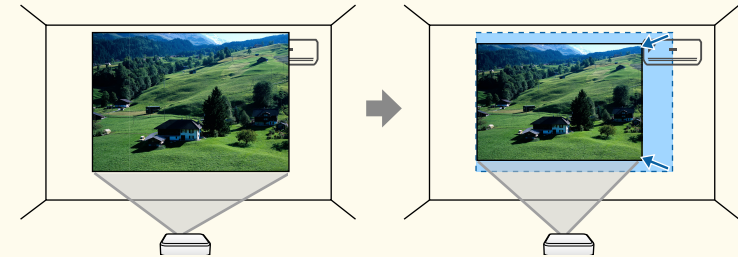

▶▶ Related Links

- "Projector Feature Settings - Projector Menu" [p.65](#)

Adjusting the Size of the Image

You can use the **Zoom** feature to adjust the size of the projected image.

- 1** Turn on the projector and display an image.
- 2** Press the  button on the remote control.
- 3** Select the menus in the following order:
 - ☛ **Image Correction > Zoom & Shift > Zoom**
 The zoom adjustment screen is displayed.

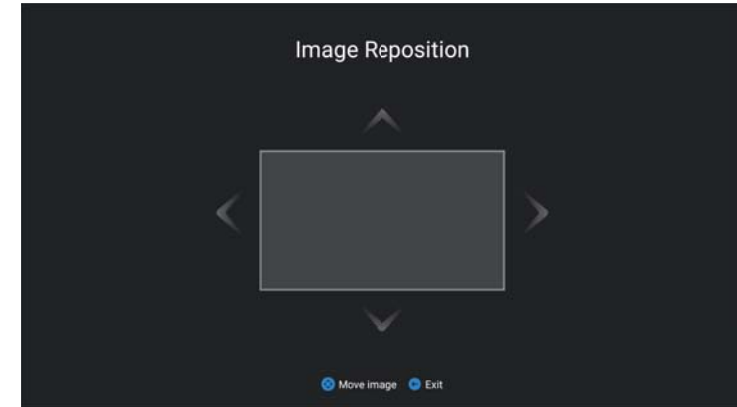
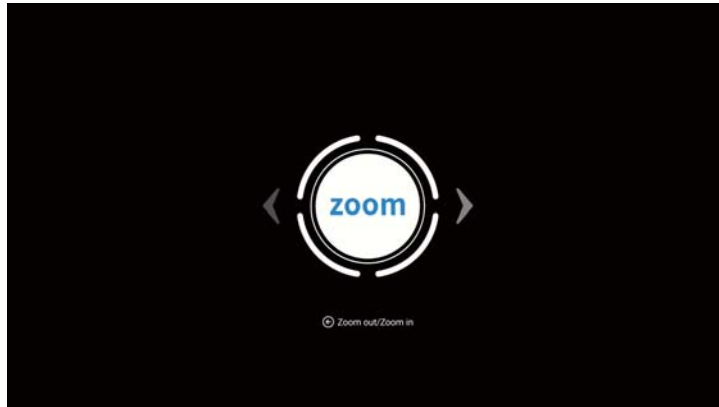

4 Use the left and right arrow buttons to adjust the image size.

5 Press  to exit the menus.

▶▶ **Related Links**

- "Projector Feature Settings - Projector Menu" [p.65](#)

4 Use the arrow buttons to adjust the image position.

5 Press  to exit the menus.

▶▶ **Related Links**

- "Projector Feature Settings - Projector Menu" [p.65](#)

Adjusting the Position of the Image

You can use the **Image Reposition** feature to adjust the position of the projected image.

1 Turn on the projector and display an image.

2 Press the  button on the remote control.

3 Select the menus in the following order:

 **Image Correction > Zoom & Shift > Image Reposition**

The image position adjustment screen is displayed.

Automatically Correcting the Image Shape with Fit to Screen

You can use the projector's **Fit to Screen** feature to automatically correct the shape and position of images to fit on your screen.

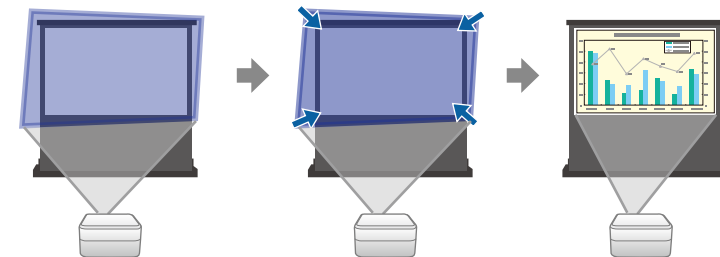

Fit to Screen operates under the following conditions:

- Screen size is from 30 to 100 inches.
- Projection distance is about 0.7 to 2.2 m.
- Projection angle is within about 15° right, left, up, or down.
- The room is not too dark.
- The projection surface is not patterned and does not deflect the projector's camera in some way.

1 Turn on the projector and display an image.

2 Press the  button on the remote control.

3 Select the menus in the following order:
☛ **Image Correction > Fit to Screen**

You see a message on the screen.

4 Expand the projection area so that it extends beyond the edges of the screen.



- Move the projector farther away from the screen as necessary.
- For example, when you project onto a wide screen in a small room and you cannot extend the projection area beyond the screen frame, the projection area must include at least the top and bottom two sides of the screen so that **Fit to Screen** detects the screen height and adjusts the image to fit the screen.



5 Select **START**.

When the adjustment screen is displayed, do not move the projector or block the image.

6 Press  to exit the menus.

▶▶ Related Links

- "Projector Feature Settings - Projector Menu" [p.65](#)

Correcting the Image Shape Manually

You can use the projector's **Manual Keystone Correction** setting to correct the shape and size of an image that is unevenly rectangular.

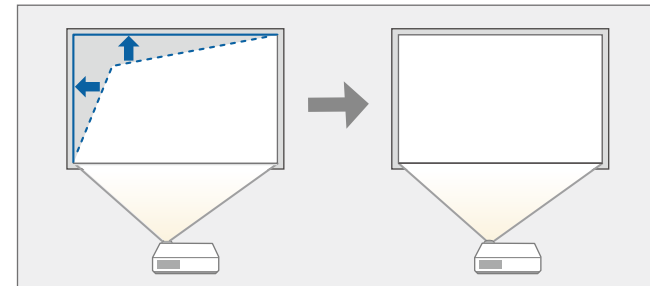

1 Turn on the projector and display an image.

2 Press the  button on the remote control.

3 Select the menus in the following order:

☛ **Image Correction > Manual Keystone Correction**

You see the **Manual Keystone Correction** screen.

- 4** Use the [Enter] button to select the point on the image you want to adjust, and adjust the image shape using the arrow buttons.

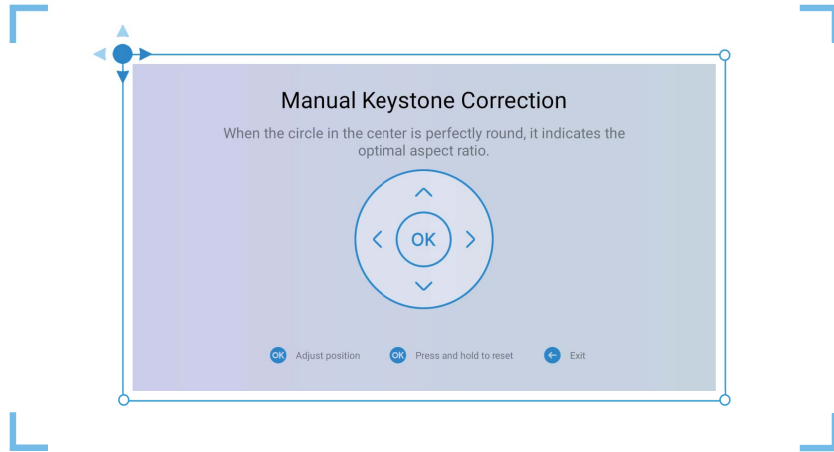

- If the direction key on the screen turns gray, you cannot make further adjustments in that direction.
- To reset the corrections, press and hold the [Enter] button.

- 5** Press  to exit the menus.

► **Related Links**

- "Projector Feature Settings - Projector Menu" [p.65](#)

You can correct the focus using the projector menus.



When you hold down the  button on the remote control, the focus of the projected image is automatically corrected. If you want to manually adjust the focus, follow the steps below.

- 1** Turn on the projector and display an image.
- 2** Press the  button on the remote control.
The focus adjustment screen is displayed.

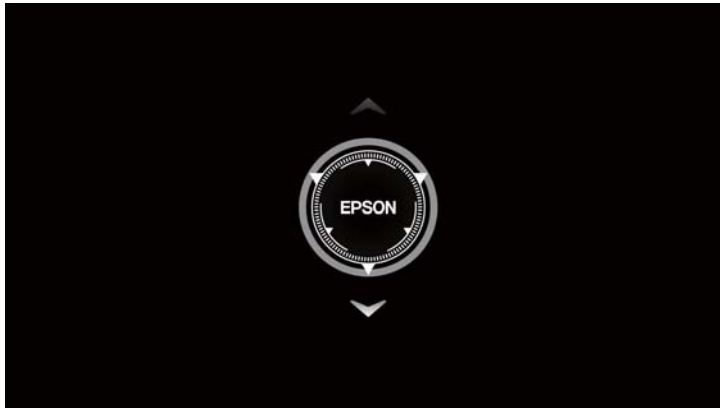

- 3** Press the up and down arrow buttons on the remote control to adjust the focus setting.
- 4** Press  to exit the menus.

When multiple image sources are connected to the projector, such as a computer and DVD player, you can switch from one image source to the other.

- 1** Make sure the connected image source you want to use is turned on.
- 2** For video image sources, insert a DVD or other video media and press play.
- 3** Press the  button on the remote control.
- 4** Press the up or down arrow button to select the image source you want.



When no image signal is detected, check the cable connections between the projector and the image source.

The projector can display images in different width-to-height ratios called aspect ratios. Normally, the input signal from your video source determines the image's aspect ratio. However, you can change the aspect ratio for certain images to fit your screen.

If you always want to use a particular aspect ratio for a certain video input source, you can select it using the projector's **Screen** menu.





You can select this setting only when the current input source is **HDMI**.

▶ Related Links

- "Changing the Image Aspect Ratio" [p.46](#)
- "Available Image Aspect Ratios" [p.46](#)

Changing the Image Aspect Ratio

You can change the aspect ratio of the displayed image.

- 1** Turn on the projector and display an image.
- 2** Press the  button on the remote control to open the dashboard.
- 3** Select  on the dashboard.
- 4** Select the menus in the following order:
☛ **Display & Sound > Screen**
- 5** Select one of the available aspect ratios for your input signal and press [Enter].
- 6** Press  to exit the menus.

Available Image Aspect Ratios

You can select the following image aspect ratios.



Note that using the aspect ratio function of the projector to reduce, enlarge, or split the projected image for commercial purposes or for public viewing may infringe upon the rights of the copyright holder of that image based on copyright law.

Aspect mode	Description
Full	Displays images using the full size of the projection area.
Super Zoom	Zooms into images. The right, left, top, and bottom edges are missing.
Unscaled	Displays images as they are.
4:3	Scales images to 4:3.
Movie expand 14:9	Scales images to 14:9.
Movie expand 16:9	Scales images to 16:9.

The projector offers different color modes to provide optimum brightness, contrast, and color for a variety of viewing environments and image types. You can select the mode designed to match your image and environment, or experiment with the available modes.



► Related Links

- "Changing the Color Mode" [p.47](#)
- "Available Color Modes" [p.47](#)

Color mode	Description
Dynamic	This is the brightest mode. Best for prioritizing brightness.
Vivid	Best for enjoying content with bright colors.
Natural	Reproduces natural colors. This is the best option when you want to adjust the image color.
Cinema	Best for enjoying content such as movies.

Changing the Color Mode





You can change the projector's color mode to optimize the image for your viewing environment.

- 1** Turn on the projector and display an image.
- 2** Press the  button on the remote control to open the dashboard.
- 3** Select  on the dashboard.
- 4** Select the menus in the following order:
☛ **Display & Sound > Picture**
- 5** Select the color mode you want to use from the list and press [Enter].
- 6** Press  to exit the menus.

Available Color Modes

You can set the projector to use these color modes, depending on your environment and image types.



You can fine-tune various aspects of how quality and colors are displayed in your projected images.

- 1** Turn on the projector and display an image.
- 2** Press the  button on the remote control to open the dashboard.
- 3** Select  on the dashboard.
- 4** Select the menus in the following order:
  **Display & Sound** > **Picture** > **Custom**
- 5** Select one of the following options:
 - To adjust the difference between light and dark areas of the image, adjust the **Contrast** setting.
 - To adjust the overall vividness of the color, adjust the **Saturation** setting.
 - To adjust the outline of the image, adjust the **Sharpness** setting.
 - To adjust the individual R (red), G (green), and B (blue) components of the gain, adjust the **Color Gain** setting.
 - To adjust the coloring, adjust the **Gamma** setting.
- 6** Press  to exit the menus.

▶▶ Related Links

- "Image Quality Settings - Display & Sound Menu" [p.67](#)



You can turn on **Dynamic Contrast** to automatically optimize the image luminance. This improves the image contrast based on the brightness of the content you project.

- 1** Turn on the projector and display an image.
- 2** Press the  button on the remote control.
- 3** Select the menus in the following order:
 - ☛ **Advanced Settings > Dynamic Contrast**
- 4** Select **On** to enable **Dynamic Contrast**.
- 5** Press  to exit the menus.

▶▶ Related Links

- "Projector Feature Settings - Projector Menu" [p.65](#)

You can adjust the brightness of your projector's light source.

- 1** Turn on the projector and display an image.
- 2** Press the  up/down buttons on the remote control to adjust the brightness.
- 3** Press  to exit the menus.

The volume buttons control the projector's internal speaker system.

- 1** Turn on the projector and start a video.
- 2** To lower or raise the volume, press the  up/down buttons on the remote control.
A volume gauge appears on the screen.



Caution

Do not start a playback at a high volume setting. Sudden loud noises may cause hearing loss.

Always lower the volume before powering off, so that you can power on and then gradually increase the volume.

The projector offers different sound modes to provide optimum sound for a variety of image types.

You can select the mode designed to match your image, or experiment with the available modes.

- 1** Turn on the projector and start a video.
- 2** Press the  button on the remote control to open the dashboard.
- 3** Select  on the dashboard.
- 4** Select the menus in the following order:
☛ **Display & Sound > Sound**
- 5** Select your sound mode and press [Enter].
- 6** Press  to exit the menus.

▶▶ Related Links

- "Available Sound Modes" [p.52](#)

Sound mode	Description
Movie	Best for audio from videos or movies. Low and high pitch sounds are emphasized.

Available Sound Modes

You can set the projector to use these sound modes, depending on the input source you are using:

Sound mode	Description
Standard	Outputs the audio using normal sound quality.
Vocal	Best for hearing voices and spoken lines.
Music	Best for music. Low and high pitch sounds are clearer.

Adjusting Projector Features

Follow the instructions in these sections to use your projector's adjustment features.

▶ Related Links

- "Using the Projector as a Bluetooth Speaker" [p.54](#)
- "Shutting Off the Image Temporarily" [p.56](#)
- "Using Google Cast™" [p.57](#)
- "HDMI CEC Features" [p.58](#)
- "Installing a Security Cable" [p.59](#)
- "Updating Projector Firmware Using Epson Projector Update" [p.60](#)
- "Initializing the Projector" [p.61](#)

You can use the projector's speaker to output audio from a video/audio device connected by Bluetooth.

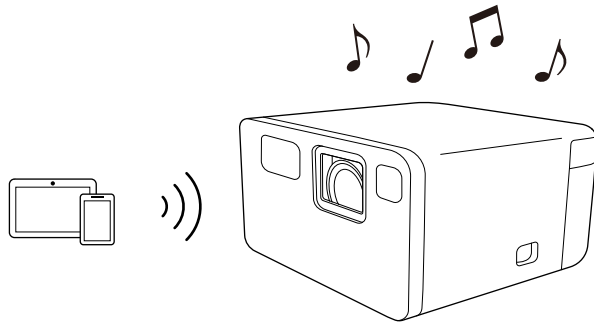

- 1** Turn on the projector and display an image.
- 2** Press the  button on the remote control.
- 3** Select **Bluetooth Speaker Mode** and press [Enter].
The **Bluetooth Speaker Mode** screen is displayed and the projected image turns off after 10 seconds.
- 4** Enable the Bluetooth function on the device you want to connect and select **EPSON Projector** from the available device list. See the documentation supplied with the device for more information.



- You can change the name **EPSON Projector**. Select another name or use a custom name from the projector's **Device name** menu.
 • **System > About > Device name**
- To cancel a Bluetooth connection, disconnect from the connected device.

- 5** To exit **Bluetooth Speaker Mode**, press and hold the  button for about two seconds.



- There is a delay in the audio output from any Bluetooth audio device.
- You cannot connect multiple video/audio devices by Bluetooth at the same time.
- You can also connect the projector to Bluetooth audio devices, such as speakers or headphones, to output the projector's audio from these devices. Select the menus in the following order to perform pairing from the menu displayed.
 • **Remotes & Accessories > Pair accessory**
- Bluetooth audio devices are not supported in some countries and regions.

▶ Related Links

- "Bluetooth Specifications" [p.54](#)

Bluetooth Specifications

Version	Bluetooth Ver. 5.1
Output	Class 1
Communication distance	Approx. 10 m
Supported profiles	A2DP, AVRCP
Frequency used	2.4 GHz band (2.402 to 2.480 GHz)
Supported codecs	SBC

Warning



Do not use the device near any medical equipment or equipment that is automatically controlled, such as automatic doors or fire alarms. Electromagnetic interference from the device may cause such equipment to malfunction and cause an accident.

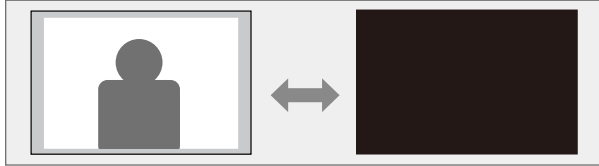

- You may not be able to connect depending on the standard and type of device.
- Even when connecting within the specified communication distance, connections can be lost due to the status of the signal.
- The communication method for Bluetooth uses the same frequency (2.4 GHz) as wireless LAN (IEEE802.11b/g) or microwave ovens. Therefore, if these devices are used at the same time, radio wave interference may occur, the audio may be interrupted, or communication may not be possible. If you do need to use these devices at the same time, make sure there is enough distance between them and the Bluetooth device.

You can temporarily turn off the projected image.



- 1** Press the  button on the remote control to open the dashboard.
- 2** Select  on the dashboard.
- 3** Select the menus in the following order:
☛ **System > Power & Energy > Power**
- 4** Select **Picture off** to turn off the projected image.
- 5** To turn the image back on, press .

▶▶ Related Links

- "System Menu" [p.68](#)

With Google Cast, you can stream entertainment from your favorite apps on your phone, tablet or laptop to Epson projectors.

- 1** Connect your device or computer to the same wireless network as the projector.
- 2** Open the Google Cast-enabled app and press .
- 3** Select your projector from the list of devices.



By default, the name of the projector is **EPSON Projector**. You can change the name by selecting another name or using a custom name from the projector's **Device name** menu.

☛ **System > About > Device name**

The app connects and starts casting to the projector.

- 4** To stop casting, press  in the app and choose the disconnect option.

When an audio/video source that meets the HDMI CEC standard is connected to the projector's HDMI port, you can use the projector's remote control to control certain features of the linked device.

▶ Related Links

- "Operating Connected Devices Using the HDMI CEC Features" [p.58](#)

Operating Connected Devices Using the HDMI CEC Features

You can control connected audio/video devices using the HDMI CEC features.



- You must also configure the connected device. See the documentation supplied with the device for more information.
- Some connected devices or functions of those devices may not operate properly even if they meet the HDMI CEC standard. See the documentation supplied with the device for more information.
- Use a cable that supports the HDMI standard.

1 Press the  button on the remote control to open the dashboard.

2 Select  on the dashboard.

3 Select the menus in the following order:
☛ **Inputs > Inputs > HDMI control**

4 Set **HDMI control** to **On**.

5 Adjust the following HDMI CEC settings as necessary.

- To automatically turn off the connected device when you turn off the projector, set **Device auto power off** to **On**.

- To automatically turn on the projector when you turn on the connected device, set **TV auto power on** to **On**.

6 Press  to exit the menus.

You can use the projector's remote control to control the linked device such as playback, stop, or adjust the volume.

▶ Related Links

- "Projector Feature Settings - Inputs Menu" [p.64](#)

You can use the security slot on the projector to install security cable (security lock) to deter theft.

▶ **Related Links**

- "Projector Parts - Rear/Side" [p.11](#)

You can get the latest version of the projector firmware by using Epson Projector Update.



- You can search for and install the Epson Projector Update app from the search window on the home screen. Be sure to install the app to keep the projector up to date.
- When the latest projector firmware is available, a notification is automatically displayed on the screen. Follow the on-screen instructions to update the firmware.

1 Press the  button on the remote control.

2 Select **Apps** and start **Epson Projector Update** by selecting it from the apps list.

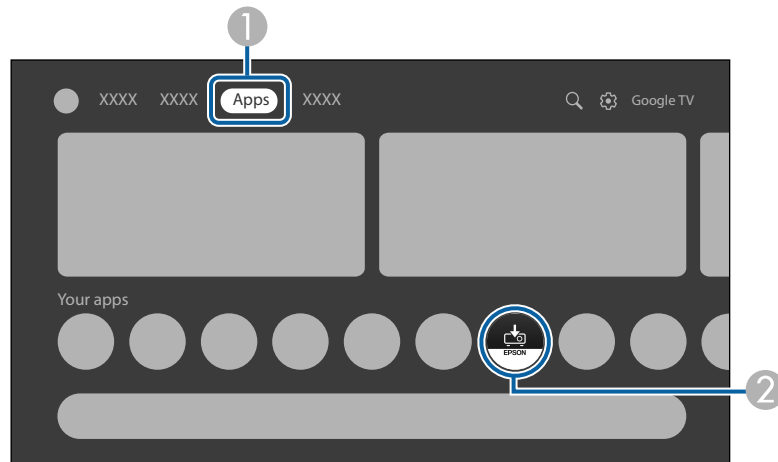

3 Follow the on-screen instructions to update the firmware.



Caution

While updating the firmware, do not operate or turn off the projector.

You can reset all of the projector settings to their default values.



If you initialize the projector, all the information such as installed apps, Google Account login information, and the projector's menu settings are deleted. Write down the settings you do not want to lose before performing initialization.

- 1** Turn on the projector and display an image.
- 2** Press the  button on the remote control to open the dashboard.
- 3** Select  on the dashboard.
- 4** Select the menus in the following order:
☛ **System > About > Reset > Factory reset**
- 5** Follow the on-screen instructions to start initializing the projector.

▶▶ Related Links

- "System Menu" [p.68](#)





Adjusting the Menu Settings

Follow the instructions in these sections to access the projector menu system and change projector settings.

► Related Links

- ["Using the Projector's Menus" p.63](#)
- ["Projector Feature Settings - Inputs Menu" p.64](#)
- ["Projector Feature Settings - Projector Menu" p.65](#)
- ["Image Quality Settings - Display & Sound Menu" p.67](#)
- ["Other Menus" p.68](#)

You can use the projector's menus to adjust the settings that control how your projector works. The projector displays the menus on the screen.

- 1** Press the  button on the remote control to open the dashboard.
- 2** Select  on the dashboard.
- 3** Press the up or down arrow buttons to move through the menus listed on the screen.
- 4** To change settings in the displayed menu, press the [Enter] button.
- 5** Press the arrow buttons to move through the settings.
- 6** Change the settings using the buttons as necessary.
- 7** When you finish changing settings on a menu, press .
- 8** Press  to exit the menus.

Settings on the **Inputs** menu let you control the audio/video device you are currently using.

Setting	Options	Description
Inputs	HDMI1	Selects a name you want to display as the name of the audio/video device that is connected to the projector's HDMI (ARC) port. To give it a name that is not in the list, select Custom .
	HDMI control	Select On to control the connected audio/video device using the projector's remote control.
	Device auto power off	Select On to automatically turn off the connected audio/video device when you turn off the projector.
	TV auto power on	Select On to automatically turn on the projector when you turn on the connected device, or when you start playback on the connected device.
	HDMI EDID Version	Displays the EDID version.
	CEC Device List	Lists the devices connected to the projector's HDMI (ARC) port.

► Related Links

- "Operating Connected Devices Using the HDMI CEC Features" [p.58](#)

Settings on the **Projector** menu provide correction methods to properly project your image.

Setting	Options	Description
Focus	Auto focus	Automatically adjusts the focus of the projected image.
	Manual Focus	Manually adjusts the focus of the projected image.
	Advanced	<p>Auto Focus at Startup: Select On to automatically correct the focus of the projected image when you turn on the projector.</p> <p>Auto Focus When Moving: Select On to automatically correct the focus of the projected image when the projector is moved or tilted.</p>
Image Correction	Auto Keystone Correction	Automatically adjusts any horizontal/vertical distortion of the projected image.
	Manual Keystone Correction	Manually adjusts any horizontal/vertical distortion of the projected image.
	Fit to Screen	Automatically corrects the shape and position of the projected image to fit on your screen.
	Zoom & Shift	<p>Zoom: Resizes the projected image.</p> <p>Image Reposition: Adjusts the image position.</p>
	Reset to Default Image	Resets all adjustment values on the Image Correction menu to their default settings.

Setting	Options	Description
	Advanced	<p>Auto Keystone Correction At Startup: Select On to automatically adjust any horizontal/vertical distortion of the projected image when you turn on the projector.</p> <p>Auto Keystone Correction on Movement: Select On to automatically adjust any horizontal/vertical distortion of the projected image when the projector is moved or tilted.</p> <p>Avoid Obstacles: Set to On to enable the Avoid Obstacles function.</p>
Bluetooth Speaker Mode	—	Opens the Bluetooth device connection screen to switch to Bluetooth Speaker Mode .
Advanced Settings	Smart Eye Protection	<p>Select On to enable the Smart Eye Protection function.</p> <p>When the projector's sensor detects obstacles that are interfering with the projection area, the brightness of the light source is automatically reduced to minimize glare.</p>
	Projection Mode	Selects the way the projector faces the screen so the image is oriented correctly.
	Remote Control	<p>Remote Control Battery Level: Displays the remaining battery level of the remote control.</p> <p>Remote Control Version: Displays the remote control version.</p>
	Product Name	Displays the product name.
	Sub System version	Displays the Sub system version.
	Dynamic Contrast	Select On to enable the Dynamic Contrast function.

► Related Links

- "Correcting the Image Shape and Focus Automatically" [p.39](#)
- "Adjusting the Size of the Image" [p.40](#)
- "Adjusting the Position of the Image" [p.41](#)
- "Automatically Correcting the Image Shape with Fit to Screen" [p.41](#)
- "Correcting the Image Shape Manually" [p.42](#)

Settings on the **Display & Sound** menu let you adjust the quality of your image and optimize the sound for the input source you are currently using.

Setting	Options	Description
Picture	Brightness	Selects the brightness of the light source.
	Dynamic	Select your favorite color mode from the list.
	Vivid	
	Natural	
	Cinema	
	Custom	<p>Contrast: Adjusts the difference between light and dark areas of the image.</p> <p>Saturation: Adjusts the overall vividness of the color.</p> <p>Sharpness: Adjusts the sharpness or softness of the image.</p> <p>Color Gain: Adjusts the individual R (red), G (green), and B (blue) components of the gain.</p> <p>Gamma: Selects the gamma to adjust the coloring.</p>
Color Temperature	Sets the color temperature according to the color mode you selected.	
	Reset to Default	Resets all adjustment values on the Picture menu to their default settings.
Screen	Full	Sets the aspect ratio (width-to-height ratio) for the input source. (This setting is available only when the current input source is HDMI.)
	Super Zoom	
	Unscaled	
	4:3	
	Movie expand 14:9	
	Movie expand 16:9	

Setting	Options	Description
Sound	Standard	Select your favorite mode for sound output from the projector's speaker system according to the playback contents.
	Vocal Music Movie	
	System Sound	Turns on/off the system sound.
Audio Output	Digital Output	Selects the sound output format when you output audio to an external audio device.
	Digital Output Delay	Adjusts the audio latency. If the audio is fast, select a higher value.

►► **Related Links**

- "Changing the Color Mode" [p.47](#)
- "Adjusting Image Quality in Detail" [p.48](#)
- "Changing the Sound Mode" [p.52](#)

Options on other menus let you customize various projector's OS features.

►► **Related Links**

- "Network & Internet Menu" [p.68](#)
- "Accounts & sign-in Menu" [p.68](#)
- "Privacy Menu" [p.68](#)
- "Apps Menu" [p.68](#)
- "System Menu" [p.68](#)
- "Remotes & Accessories Menu" [p.69](#)
- "Help & Feedback Menu" [p.69](#)

Network & Internet Menu

Settings on the **Network & Internet** menu let you view network information and set up the projector for controlling over a network.

Accounts & sign-in Menu

Settings on the **Accounts & sign-in** menu let you add new Google Accounts used to log in to the projector, and make detailed settings for these accounts.

Privacy Menu

Settings on the **Privacy** menu let you change your privacy and security settings.

Apps Menu

The **Apps** menu displays your most recently used apps or all the apps that are installed on the projector.

System Menu

Settings on the **System** menu let you customize various projector features.

Setting	Description
Accessibility	Allows you to make settings for accessibility, such as subtitles and text reading.
About	Displays the projector's preferences and status. You can return all the projector settings to their factory default values from this menu.
Date & Time	Adjusts the projector's system time and date settings.
Language	Select the language used for the projector menus and messages.
Keyboard	Allows you to make detailed settings for the virtual keyboard installed in the projector's menu.
Storage	Allows you to display the usage status of the internal storage and clean the cache.
Ambient mode	Allows you to make settings for the screen saver.
Power & Energy	Allows you to make settings for power and energy saving such as the Sleep Timer or Picture off features.
Cast	Google Cast is a platform that lets you stream your favorite entertainment from your phone, tablet or laptop right to your projector.
System Sound	Turns on/off the system sound.
Restart	Restarts the projector.

►► **Related Links**

- "Initializing the Projector" [p.61](#)
- "Shutting Off the Image Temporarily" [p.56](#)

Remotes & Accessories Menu

Settings on the **Remotes & Accessories** menu let you pair the remote control and the projector, or let you connect/disconnect your Bluetooth devices to the projector.

Help & Feedback Menu

The **Help & Feedback** menu provides a link to the projector's OS help page, or lets you send feedback or comments about the product.

Maintaining the Projector

Follow the instructions in these sections to maintain your projector.

▶ Related Links

- "Projector Maintenance" [p.71](#)
- "Cleaning the Lens" [p.72](#)
- "Cleaning the Projector Case" [p.73](#)
- "Air Filter and Vent Maintenance" [p.74](#)

You may need to clean the projector's lens periodically, and clean the air filter and air vents to prevent the projector from overheating due to blocked ventilation.

The only part you should replace is the remote control batteries. If any other part needs replacing, contact Epson or an authorized Epson distributor.

 **Warning**

Before cleaning any part of the projector, turn it off and unplug the power cord. Never open any cover on the projector, except as specifically explained in this manual. Dangerous electrical voltages in the projector can injure you severely.

Clean the projector's lens periodically, or whenever you notice dust or smudges on the surface.

- To remove dust or smudges, gently wipe the lens with clean and dry lens-cleaning paper.
- If the lens is dusty, blow off dust using a blower, and then wipe the lens.

Warning

- Before cleaning the lens, turn off the projector and unplug the power cord.
- Do not use any flammable gas sprays such as air dusters to blow off dust. The high heat generated by the projector may cause a fire.

Attention

- Do not wipe the lens right after you turn off the projector. Doing so could damage the lens.
- Do not use any harsh materials to clean the lens and do not subject the lens to any impacts; otherwise, it could be damaged.

Before cleaning the projector case, turn off the projector and unplug the power cord.

- To remove dust or dirt, use a soft, dry, lint-free cloth.
- To remove stubborn dirt, use a soft cloth moistened with water and mild soap. Do not spray liquid directly on the projector.

Attention

Do not use wax, alcohol, benzene, paint thinner, or other chemicals to clean the projector case. These can damage the case. Do not use canned air, or the gases may leave a flammable residue.

Regular filter maintenance is important to maintain your projector. Clean the air filter when a message appears telling you the temperature inside the projector has reached a high level. It is recommended that you clean these parts about once every year. Clean them more often than this if you use the projector in an environment that is dustier than expected. (Assuming the projector is used in an atmosphere in which airborne particulate matter is less than 0.04 to 0.2 mg/m³.)

► Related Links

- "Cleaning the Air Filters and Intake Vents " [p.74](#)

Cleaning the Air Filters and Intake Vents

You need to clean the projector's air filter or air intake vents in the following situations:

- The filter or vents get dusty.
- The projector's Status indicator turns orange.

- 1** Turn off the projector and unplug the power cord.
- 2** Gently remove the dust using a small vacuum designed for computers or a very soft brush (such as a paintbrush).

EF-21

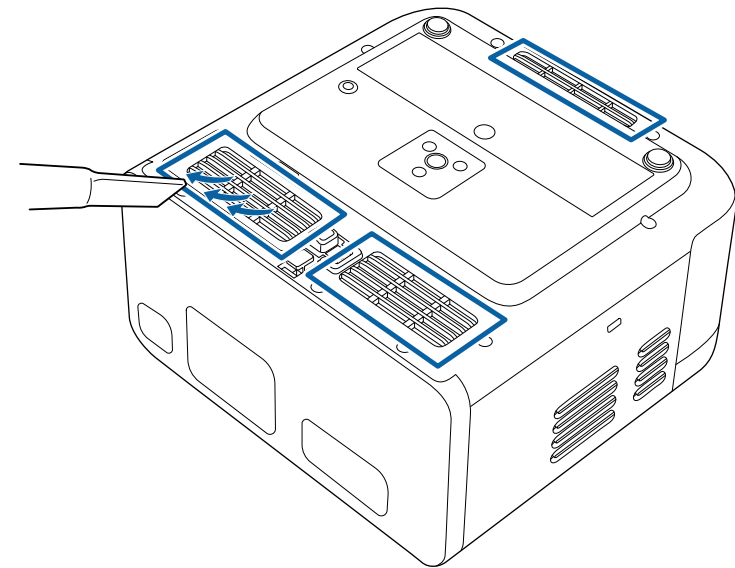

EF-22

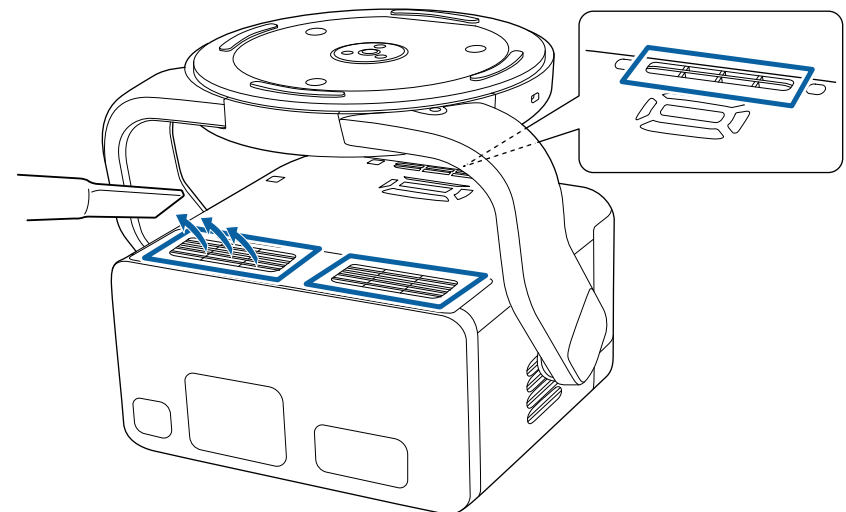

Attention

- Do not rinse the air filter in water, or use any detergent or solvent to clean it.
- Do not directly vacuum the air filter. Doing so could damage the filter.
- Do not use canned air. The gases may leave a flammable residue or push dust and debris into the projector's optics or other sensitive areas.
- If dust is difficult to remove or the air filter is damaged, contact Epson to request help with replacing the air filter.

Solving Problems

Check the solutions in these sections if you have any problems using the projector.

► Related Links

- "Projection Problems" [p.77](#)
- "Projector Indicator Status" [p.78](#)
- "Solving Projector Power-On or Power-Off Problems" [p.80](#)
- "Solving Image Problems" [p.81](#)
- "Solving Sound Problems" [p.85](#)
- "Solving Remote Control Operation Problems" [p.87](#)
- "Solving HDMI CEC Problems" [p.88](#)
- "Solving Wi-Fi Network Problems" [p.89](#)
- "Solving Projector's OS Problems" [p.90](#)

If the projector is not working properly, turn it off, unplug it, and then plug it back in and turn it on.

If this does not solve the problem, check the following:

- The indicators on the projector may indicate the problem.
- The solutions in this manual can help you solve many problems.

If none of these solutions help, contact Epson for technical support.

The indicators on the projector indicate the projector status and let you know when a problem occurs. Check the status and color of the indicators and then refer to this table for a solution.



If the indicators display a pattern not listed in the table below, turn the projector off, unplug it, and contact Epson for help.

EF-21

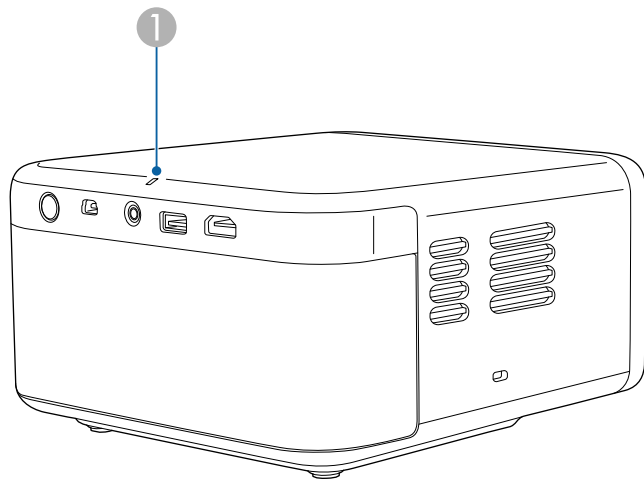

EF-22

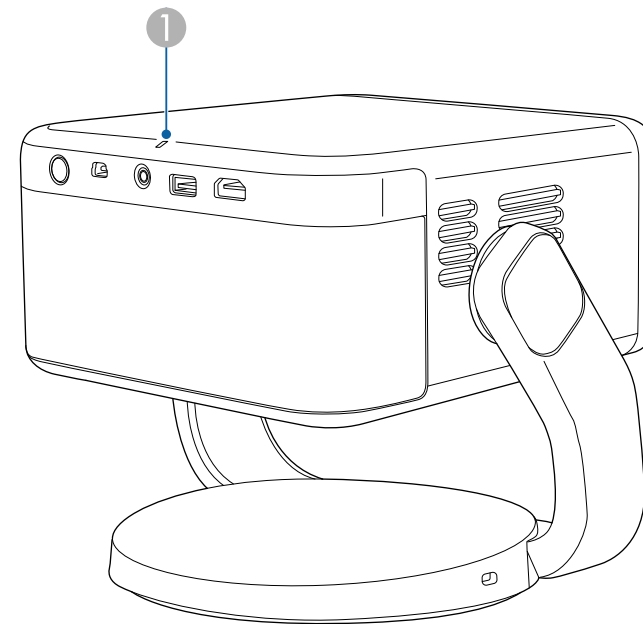

1 Status indicator

Projector status

Indicator status	Problem and solutions
Lit blue	Normal operation.
Flashing blue	Warming up or updating the projector firmware. Remote control operations may be disabled when the indicator is flashing blue.
Off	Standby. When you press the power button, projection starts.

Indicator status	Problem and solutions
Lit orange	<p>Projector has overheated and turned off. Leave it turned off to cool down for 5 minutes.</p> <ul style="list-style-type: none">• Make sure that the vents and air filter are not clogged with dust or obstructed by nearby objects.• Make sure the environmental temperature is not too hot.• Clean or replace the air filter.• If the problem persists, unplug the projector and contact Epson for help.
Flashing orange	<p>Internal projector error.</p> <p>Turn the projector off, unplug it, and contact Epson for help.</p>

▶▶ Related Links

- "Cleaning the Air Filters and Intake Vents " [p.74](#)

Check the solutions in these sections if the projector does not turn on when you press the power button or it turns off unexpectedly.

▶ Related Links

- "Solving Projector Power Problems" [p.80](#)
- "Solving Projector Shutdown Problems" [p.80](#)

Solving Projector Power Problems

If the projector does not turn on when you press the power button, try the following steps until the problem is solved.

- 1** Make sure the power cord is securely connected to the projector and to a working electrical outlet.
- 2** If you are using the remote control, check the batteries of the remote control.
- 3** The power cord may be defective. Disconnect the cord and contact Epson for help.

Solving Projector Shutdown Problems

If the projector's light source turns off unexpectedly, try the following steps until the problem is solved.

- 1** The projector may have entered sleep mode after the interval of time specified in **Sleep Timer** in the projector's **Power & Energy** menu has passed. Press the power button on the projector or remote control to wake the projector.

☛ **System > Power & Energy > Power > Sleep Timer**



After waking the projector, **Sleep Timer** is automatically set to **Off**.

- 2** The projector may have turned off after the interval of time specified in **Switch Off Timer** in the projector's **Power & Energy** menu has passed. Press the power button on the projector or remote control to turn back on the projector.

☛ **System > Power & Energy > Power > Switch Off Timer**

- 3** When the status indicator is lit orange, the projector has overheated and turned off.



The cooling fans may run in standby status depending on the projector settings. Also, when the projector wakes from standby status, the fans may cause an unexpected noise. This is not a malfunction.

▶ Related Links

- "System Menu" [p.68](#)

Check the solutions in these sections if you have any problems with projected images.

▶▶ Related Links

- "Solving Missing Image Problems" [p.81](#)
- "Adjusting an Image that is not Rectangular" [p.81](#)
- "Adjusting a Fuzzy or Blurry Image" [p.82](#)
- "Fixing Partial Image Problems" [p.83](#)
- "Adjusting an Image that Contains Noise or Static" [p.83](#)
- "Adjusting an Image with Incorrect Brightness or Colors" [p.83](#)
- "Adjusting an Upside-down Image" [p.84](#)
- "Solving Auto Correction Problems" [p.84](#)

Solving Missing Image Problems

If no image is displayed, try the following steps until the problem is solved.

1 Check the projector's status:

- Check the status indicator to confirm that the projector is in normal operating status.
- Press the projector's power button to wake it from standby or sleep mode.
 - ▶▶ **System > Power & Energy > Power > Sleep Timer**

2 Check the cable connection:

- Make sure all necessary cables are securely connected and the power is on for the projector.
- Connect the video source directly to the projector.
- Replace the HDMI cable with the shorter one.

3 Check the status of your video source:

- Make sure the connected device meets the HDMI CEC standard. See the documentation supplied with the device for more information.
- If you are projecting from a laptop computer, make sure it is set up to display on an external monitor.

4 Check the following items:

- You need an Internet connection to view online content. Make sure your Wi-Fi is on.
- Set the CEC function for the connected device again and restart the device.
- Make sure the computer's display resolution does not exceed the projector's resolution and frequency limits. If necessary, select a different display resolution for your computer. (See your computer manual for details.)
- Resets all of the projector settings to their default values.

▶▶ Related Links

- "System Menu" [p.68](#)

Adjusting an Image that is not Rectangular

If the projected image is not evenly rectangular, try the following steps until the problem is solved.

- 1 Place the projector directly in front of the center of the screen, facing it squarely, if possible.

2 Make sure that **Auto Keystone Correction At Startup** and **Auto Keystone Correction on Movement** are set to **On** in the **Projector** menu.

☛ **Projector > Image Correction > Advanced > Auto Keystone Correction At Startup**

☛ **Projector > Image Correction > Advanced > Auto Keystone Correction on Movement**

3 Select **Auto Keystone Correction** in the **Projector** menu to automatically adjust the image shape.

☛ **Projector > Image Correction > Auto Keystone Correction**

4 When projecting on a screen, use **Fit to Screen** to automatically correct the shape and position of the image so that it fits on your screen.

☛ **Projector > Image Correction > Fit to Screen**

5 Adjust the image shape manually using **Manual Keystone Correction** in the **Projector** menu.

☛ **Projector > Image Correction > Manual Keystone Correction**



If you cannot correct the focus and any distortion of the projected image, turn off the projector and disconnect the power cord, then reconnect the power cord and turn the projector back on. If a warning screen is displayed when you turn on the projector, contact Epson for help.

▶▶ Related Links

- "Projector Feature Settings - Projector Menu" [p.65](#)

Adjusting a Fuzzy or Blurry Image

If the projected image is fuzzy or blurry, try the following steps until the problem is solved.

1 Hold down the  button on the remote control to perform **Auto focus**.

2 Press the  button on the remote control to display the focus adjustment screen and adjust focus manually.

3 Check the following items:

- Position the projector close enough to the screen.
- Position the projector so the keystone adjustment angle is not so wide that it distorts the image.

4 Clean the projector's lens.



To avoid condensation on the lens after bringing the projector in from a cold environment, let the projector warm up to room temperature before using it.

5 Adjust the **Sharpness** setting in the projector's **Display & Sound** menu to improve image quality.

☛ **Display & Sound > Picture > Custom > Sharpness**

6 If you are projecting from a computer, use a lower resolution or select a resolution that matches the projector's native resolution.



If you cannot correct the focus and any distortion of the projected image, turn off the projector and disconnect the power cord, then reconnect the power cord and turn the projector back on. If a warning screen is displayed when you turn on the projector, contact Epson for help.

▶▶ Related Links

- "Image Quality Settings - Display & Sound Menu" [p.67](#)

Fixing Partial Image Problems

If only a partial image is displayed, try the following steps until the problem is solved.

- 1** Adjust the position of the projected image using the **Image Reposition** setting in the **Projector** menu.
☛ **Projector > Image Correction > Zoom & Shift > Image Reposition**
- 2** Select an appropriate aspect ratio from the **Screen** menu according to the current input source. (Available only when the current input source is HDMI.)
☛ **Display & Sound > Screen**
- 3** Make sure you select the correct projection mode. You can select this from the **Projection Mode** menu.
☛ **Projector > Advanced Settings > Projection Mode**
- 4** Check your computer display settings to disable dual display and set the resolution within the projector's limits. (See your computer manual for details.)

▶▶ Related Links

- "Projector Feature Settings - Projector Menu" [p.65](#)
- "Image Quality Settings - Display & Sound Menu" [p.67](#)

Adjusting an Image that Contains Noise or Static

If the projected image contains electronic interference (noise) or static, try the following steps until the problem is solved.

- 1** Check the cables connecting your video source to the projector. They should be:
 - Separated from the power cord to prevent interference
 - Securely connected at both ends
 - Not connected to an extension cable
- 2** If you adjusted the image shape using the projector controls, try decreasing the **Sharpness** setting in the projector's **Display & Sound** menu to improve image quality.
☛ **Display & Sound > Picture > Custom > Sharpness**
- 3** If you connected an extension power cable, try projecting without it to see if it caused interference in the signal.
- 4** Select a computer video resolution and refresh rate that are compatible with the projector.

▶▶ Related Links

- "Image Quality Settings - Display & Sound Menu" [p.67](#)

Adjusting an Image with Incorrect Brightness or Colors

If the projected image is too dark or bright, or the colors are incorrect, try the following steps until the problem is solved.

- 1** Try different color modes for your image and environment by selecting the color mode setting in the projector's **Picture** menu.
☛ **Display & Sound > Picture**
- 2** Check your video source settings.

3 Adjust the settings for **Custom** and **Color Temperature** in the **Picture** menu for the current input source.

☛ **Display & Sound > Picture**

4 Make sure all the cables are securely connected to the projector and your video equipment. If you connected long cables, try connecting shorter cables.

5 Position the projector close enough to the screen.

▶▶ **Related Links**

- "Image Quality Settings - Display & Sound Menu" [p.67](#)

Adjusting an Upside-down Image

If the projected image is upside-down, select the correct projection mode.

☛ **Projector > Advanced Settings > Projection Mode**

▶▶ **Related Links**

- "Projector Feature Settings - Projector Menu" [p.65](#)

Solving Auto Correction Problems

Try the following steps if you cannot automatically correct focus and vertical/horizontal distortion of the projected image in the following situations:

- When you turn on the projector.
- When the projector is moved or tilted.
- When you perform **Auto focus**.
- When you perform **Auto Keystone Correction**.

1 Check the projector's status:

- Remove any obstacles that are blocking the projector's camera and sensor.
- Clean the projector's camera and sensor if they are dusty or dirty.
- Do not move the projector while correcting the focus and keystone distortion.

2 Check the installation environment of the projector.

- Focus and keystone distortion of the projected image are automatically corrected under the following conditions:
 - When the size of the projected image (diagonal length) before correcting focus and keystone distortion is from 30 to 100 inches.
 - When the projection distance is about 0.7 to 2.2 m.
 - When the installation angle of the projector toward the projection surface is within 20° right, left, up, or down.
- Remove any obstacles between the projector and the projection surface as these can interrupt the projection.
- If you are using the projector in a bright room, darken the room. Do not change the room brightness while automatically correcting focus and keystone distortion.
- Project the image on to a plain and flat surface. Do not project the image on to a patterned surface or a unlevel surface.



If you cannot correct the focus and any distortion of the projected image, turn off the projector and disconnect the power cord, then reconnect the power cord and turn the projector back on. If a warning screen is displayed when you turn on the projector, contact Epson for help.

▶▶ **Related Links**

- "Correcting the Image Shape and Focus Automatically" [p.39](#)



Check the solutions in these sections if you have any problems with projected sound.

▶ Related Links

- "Solving Missing or Low Audio Problems" [p.85](#)
- "Solving Bluetooth Speaker Mode Problems" [p.85](#)

Solving Missing or Low Audio Problems

If there is no sound or the volume is too low, try the following steps until the problem is solved.

- 1** Adjust the projector's volume settings using the  up/down buttons on the remote control.
- 2** Check the cable connection between the projector and your video source.
- 3** Check your video source to make sure the volume is turned up and the audio output is set for the correct source.
- 4** If you want to output audio to an external audio device that supports HDMI ARC using an HDMI cable, try the following solutions:
 - Set **HDMI control** to **On** in the **Inputs** menu.
 **Inputs > Inputs > HDMI control**
 - Make sure the HDMI cable is compliant with HDMI ARC.



When outputting audio to an external audio device that does not support HDMI ARC using an HDMI cable, set **HDMI control** to **Off** in the **Inputs** menu.

 **Inputs > Inputs > HDMI control**

- 5** If audio is not output to an external audio device that supports HDMI ARC, try changing **Auto** to **PCM** as the **Digital Output** setting.

 **Display & Sound > Audio Output > Digital Output**

▶ Related Links

- "Projector Feature Settings - Inputs Menu" [p.64](#)
- "Image Quality Settings - Display & Sound Menu" [p.67](#)

Solving Bluetooth Speaker Mode Problems

If you cannot connect a Bluetooth audio device to the projector, try the following solutions.

- 1** Select **Bluetooth Speaker Mode** in the **Projector** menu and press the [Enter] button on the remote control.
- 2** Select **EPSON Projector** from the available Bluetooth device list displayed on your device.



By default, the name of the projector is **EPSON Projector**. You can change the name by selecting another name or using a custom name from the projector's **Device name** menu.

 **System > About > Device name**

- 3** Check your Bluetooth audio device to make sure the volume is turned up and the audio output settings are correct.
- 4** Make sure only one Bluetooth device is connected to the projector. You cannot connect multiple Bluetooth audio devices to the projector at the same time.
- 5** Make sure the device meets the projector's Bluetooth specifications.

6 Check the following items:

- Check for obstacles between the Bluetooth audio device and the projector, and change their positions to improve communication.
- Make sure the connected Bluetooth audio device is within the specified communication distance.
- Avoid using the projector near wireless networks, microwave ovens, 2.4 GHz cordless phones, or other devices that use the 2.4 GHz frequency band. These devices can interfere with the signal between the projector and the Bluetooth audio device.



► **Related Links**

- "Using the Projector as a Bluetooth Speaker" [p.54](#)
- "Bluetooth Specifications" [p.54](#)

If the projector does not respond to remote control commands, try the following steps until the problem is solved.



If you lose the remote control, you can order another one. Contact Epson for help.

- 1** Check that the remote control batteries are installed correctly and have power. If necessary, replace the batteries.
- 2** Check to see if a button on the remote control is stuck down, causing it to enter sleep mode. Release the button to wake the remote control up.
- 3** If the pairing screen is displayed, perform pairing again by holding down the  button and  button on the remote control at the same time for about three seconds.
- 4** Perform pairing again by displaying the pairing screen manually from the **Remotes & Accessories** menu.
- 5** If the image is projected from the projector, make sure you are operating the remote control within the reception angle and range of the projector.
- 6** Strong fluorescent lighting, direct sunlight, or infrared device signals may be interfering with the projector's remote receivers. Dim the lights or move the projector away from the sun or interfering equipment.

► Related Links

- "Remote Control Operation" [p.26](#)
- "Installing Batteries in the Remote Control" [p.26](#)
- "Projector Indicator Status" [p.78](#)

If you cannot operate the connected devices from the projector, try the following steps until the problem is solved.

- 1** Make sure the cable meets the HDMI CEC standard.
- 2** Make sure the connected device meets the HDMI CEC standard. See the documentation supplied with the device for more information.
- 3** Set **HDMI control** to **On** in the **Inputs** menu.
☛ **Inputs > Inputs > HDMI control**
- 4** Make sure all the cables are securely connected to the projector and your video equipment.
- 5** Make sure the connected devices are turned on and in standby status. See the documentation supplied with the device for more information.
- 6** If you connect a new device or change the connection, set the CEC function for the connected device again and restart the device.

▶ **Related Links**

- "Projector Feature Settings - Inputs Menu" [p.64](#)
- "Projector Indicator Status" [p.78](#)

If you cannot connect to a Wi-Fi network, try the following solutions.

- 1** Make sure your Wi-Fi router and modem are working properly. Rebooting these devices may solve the network connection problem.
- 2** Check for obstacles between the Wi-Fi router and the projector, and change their positions to improve communication.
- 3** You can check the network settings from **Wi-Fi** in the **Network & Internet** menu.
- 4** If you initialize the projector, you need to select the network settings again on the initial setup screen.

▶ **Related Links**

- "Initializing the Projector" [p.61](#)

See the following page if you have any problems when watching the online content.

<https://support.google.com/googletv/>



If there is not enough space in the internal storage, system updates may fail. Free up space by deleting unnecessary apps and caches, then try updating again.

Appendix

Check these sections for the technical specifications and important notices about your product.

► Related Links

- "Optional Accessories and Replacement Parts" [p.92](#)
- "Screen Size and Projection Distance" [p.93](#)
- "Supported Monitor Display Resolutions" [p.95](#)
- "Projector Specifications" [p.96](#)
- "External Dimensions" [p.98](#)
- "List of Safety Symbols and Instructions" [p.100](#)
- "Laser Safety Information" [p.102](#)
- "Glossary" [p.106](#)
- "Notices" [p.107](#)

The following optional accessories and replacement parts are available. Please purchase these products as and when needed.

The following list of optional accessories and replacement parts is current as of: July 2024.

Details of accessories are subject to change without notice and availability may vary depending on the country of purchase.

▶▶ Related Links

- "Mounts" [p.92](#)

Mounts

Safety Wire Set ELPWR01

Use when connecting the projector to the location where the projector is installed to prevent it from falling.



Special expertise is required to suspend the projector from a ceiling.

▶▶ Related Links

- "Mounting the Projector on a Tripod or Projector Stand" [p.21](#)

Check the table here to determine how far to place the projector from the screen based on the size of the projected image.

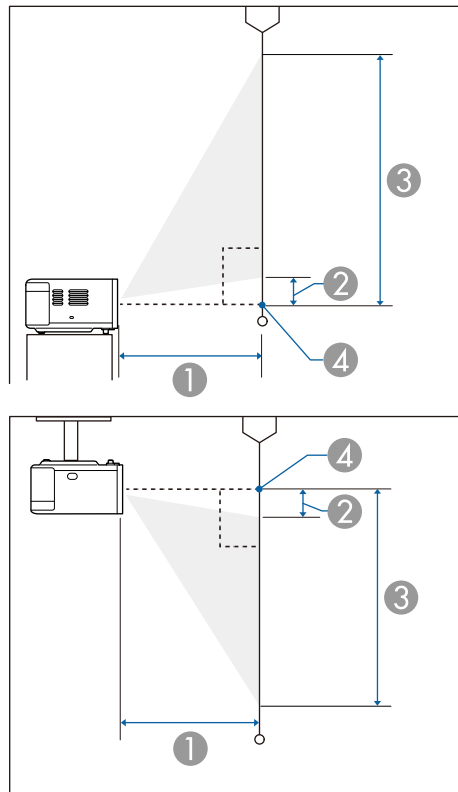

- ① Projection distance (cm)
- ② Distance from the projector to the bottom of the screen (cm)
- ③ Distance from the projector to the top of the screen (cm)
- ④ Center of lens

16:9 screen size		①	②	③
		Minimum (Wide)	Minimum (Wide)	Minimum (Wide)
30"	66 × 37	64	0	37
40"	89 × 50	87	0	50
50"	111 × 62	110	0	62
60"	133 × 75	132	0	75
70"	155 × 87	155	0	87
80"	177 × 100	178	0	100
90"	199 × 112	201	0	112
100"	221 × 125	224	0	125
120"	266 × 149	269	0	149
150"	332 × 187	337	0	187

16:10 screen size		①	②	③
		Minimum (Wide)	Minimum (Wide)	Minimum (Wide)
30"	65 × 40	70	0	40
40"	86 × 54	94	0	54
50"	108 × 67	119	0	67
60"	129 × 81	144	0	81
70"	151 × 94	168	0	94
80"	172 × 108	193	0	108
90"	194 × 121	217	0	121
100"	215 × 135	242	0	135
120"	258 × 162	291	0	162
130"	280 × 175	316	0	175

16:10 screen size		①	②	③
		Minimum (Wide)	Minimum (Wide)	Minimum (Wide)
140"	302 × 188	341	0	188

4:3 screen size		①	②	③
		Minimum (Wide)	Minimum (Wide)	Minimum (Wide)
30"	61 × 46	79	0	46
40"	81 × 61	107	0	61
50"	102 × 76	135	0	76
60"	122 × 91	163	0	91
70"	142 × 107	191	0	107
80"	163 × 122	219	0	122
90"	183 × 137	247	0	137
100"	203 × 152	275	0	152
120"	244 × 183	330	0	183

See the *Supplemental A/V Support Specification* for detailed information on compatible refresh rates and resolutions for each compatible video display format.

EF-21

Product name	EF-21W/EF-21R/EF-21G
Dimensions	197 (W) × 110.5 (H) × 191 (D) mm (not including raised section)
LCD panel size	0.62"
Display method	3LCD
Number of pixels	Full HD (1,920 (W) × 1,080 (H) dots) × 3
Screen resolution	2,073,600 pixels (1,920 × 1,080)
Focus adjustment	Auto
Zoom adjustment	1.0 to 1.82 (Digital)
Light source	Laser diode
Light source output power	Up to 24.5 W
Wavelength	449 to 461 nm
Laser class (internal laser light source)	Class 4
Light source life *	Up to about 20,000 hours
Max. audio output	5 W × 2
Speaker	2 (Stereo)
Power supply	100 - 240 V AC±10%, 50/60 Hz 1.1 - 0.5 A
Operating power consumption (100 to 120 V area)	When the light source brightness is 100%: 109 W When the light source brightness is 50%: 80 W
Operating power consumption (220 to 240 V area)	When the light source brightness is 100%: 106 W When the light source brightness is 50%: 78 W
Standby power consumption	Communication On: 2.0 W Communication Off: 0.5 W

Operating altitude	Altitude 0 to 3,000 m
Operating temperature **	Altitude of 0 to 2,286 m: 5 to +35°C (Humidity of 20 to 80%, No condensation) Altitude of 2,287 to 3,000 m: 5 to +30°C (Humidity of 20 to 80%, No condensation)
Storage temperature	-10 to +60°C (Humidity of 10 to 90%, No condensation)
Mass	Approx. 2.3 kg

* Approximate time until the light source brightness decreases to half of its original value. (Assuming the projector is used in an atmosphere in which airborne particulate matter is less than 0.04 to 0.2mg/m³. The estimated time varies depending on the projector usage and operating conditions.)

** Light source brightness automatically dims if the surrounding temperature gets too high.

The rating label is attached on the bottom of the projector.

This product is also designed for IT power distribution system with phase-to-phase voltage 230V.

EF-22

Product name	EF-22B/EF-22N
Dimensions	236 (W) × 191 (H) × 191 (D) mm (not including raised section)
LCD panel size	0.62"
Display method	3LCD
Number of pixels	Full HD (1,920 (W) × 1,080 (H) dots) × 3
Screen resolution	2,073,600 pixels (1,920 × 1,080)
Focus adjustment	Auto
Zoom adjustment	1.0 to 1.82 (Digital)
Light source	Laser diode

Light source output power	Up to 24.5 W
Wavelength	449 to 461 nm
Laser class (internal laser light source)	Class 4
Light source life *	Up to about 20,000 hours
Max. audio output	5 W × 2
Speaker	2 (Stereo with passive radiators)
Power supply	24V DC 4.2A
Operating power consumption (100 to 120 V area)	When the light source brightness is 100%: 105 W When the light source brightness is 50%: 75 W
Operating power consumption (220 to 240 V area)	When the light source brightness is 100%: 103 W When the light source brightness is 50%: 73 W
Standby power consumption	Communication On: 2.0 W Communication Off: 0.5 W
Operating altitude	Altitude 0 to 3,000 m
Operating temperature **	Altitude of 0 to 2,286 m: 5 to +35°C (Humidity of 20 to 80%, No condensation) Altitude of 2,287 to 3,000 m: 5 to +30°C (Humidity of 20 to 80%, No condensation)
Storage temperature	-10 to +60°C (Humidity of 10 to 90%, No condensation)
Mass	Approx. 3.0 kg

* Approximate time until the light source brightness decreases to half of its original value. (Assuming the projector is used in an atmosphere in which airborne particulate matter is less than 0.04 to 0.2mg/m3. The estimated time varies depending on the projector usage and operating conditions.)

** Light source brightness automatically dims if the surrounding temperature gets too high.

The rating label is attached on the bottom of the projector.

This product is also designed for IT power distribution system with phase-to-phase voltage 230V.

► **Related Links**

- "AC Adapter Specifications (EF-22)" [p.97](#)
- "Connector Specifications" [p.97](#)

AC Adapter Specifications (EF-22)

Manufacturer	EPSON
Model	AD10370LF
Input power	100-240V AC ±10% 50/60Hz 1.75A
Output power	24.0V DC 5.0A 120.0W

Connector Specifications

Audio Out port	1	Stereo mini pin jack
HDMI (ARC) port	1	HDMI
USB-A port	1	USB connector (Type A)
Service port	1	USB connector (Mini-B)



USB ports are not guaranteed to operate all devices that support USB.

EF-21

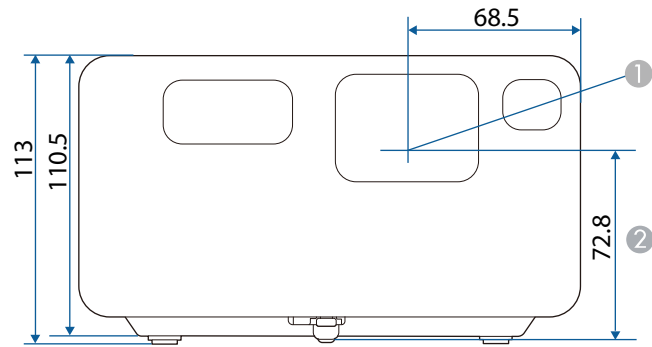

- ① Center of lens
- ② Distance from center of lens to tripod fixing point

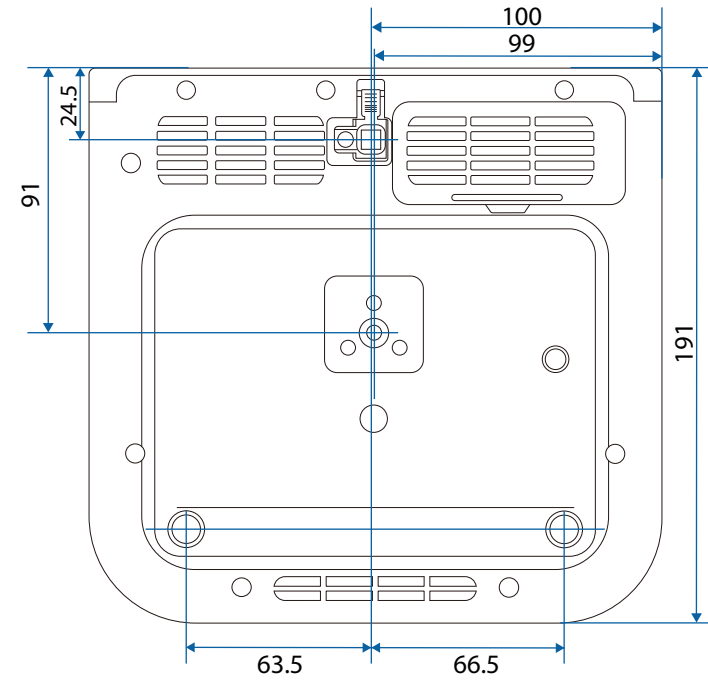

The unit in these illustrations is mm.

EF-22

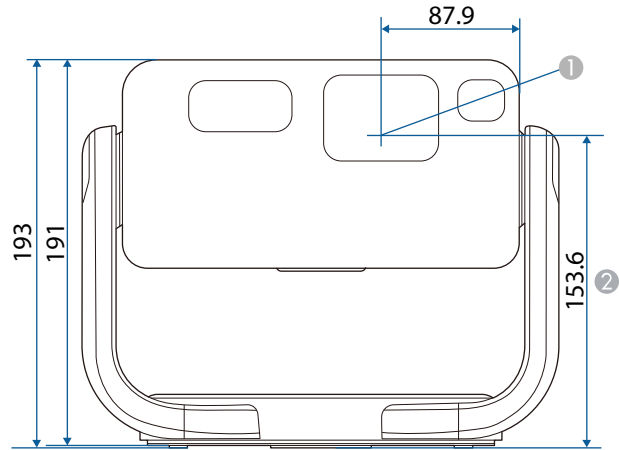

- ① Center of lens
- ② Distance from center of lens to tripod fixing point

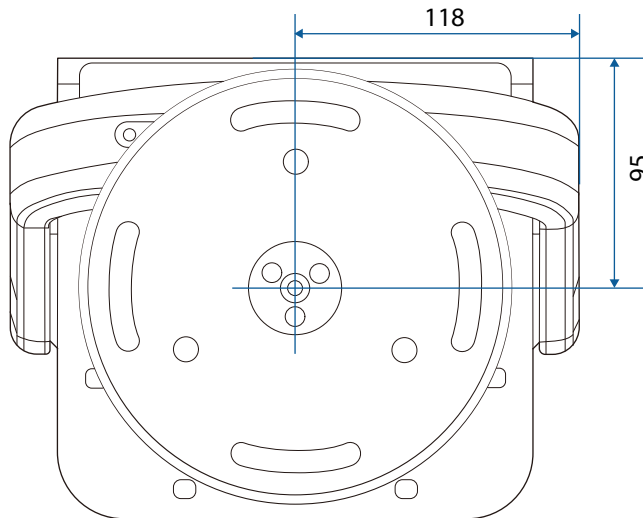



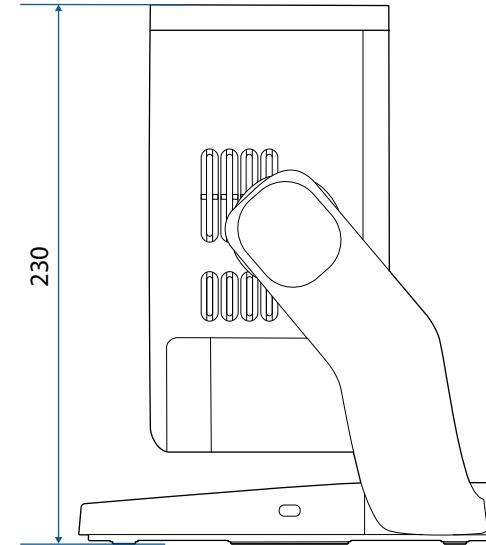









When projecting images onto a ceiling by tilting the projector 90 degrees upwards









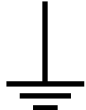





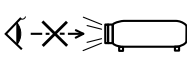

The unit in these illustrations is mm.

The following table lists the meaning of the safety symbols labeled on the equipment.

No.	Symbol mark	Approved standards	Description
1		IEC60417 No. 5007	"ON" (power) To indicate connection to the mains.
2		IEC60417 No. 5008	"OFF" (power) To indicate disconnection from the mains.
3		IEC60417 No. 5009	Stand-by To identify the switch or switch position by means of which part of the equipment is switched on in order to bring it into the stand-by condition.
4		ISO7000 No. 0434B, IEC3864-B3.1	Caution To identify general caution when using the product.
5		IEC60417 No. 5041	Caution, hot surface To indicate that the marked item can be hot and should not be touched without taking care.
6		IEC60417 No. 6042 ISO3864-B3.6	Caution, risk of electric shock To identify equipment that has risk of electric shock.
7		IEC60417 No. 5957	For indoor use only To identify electrical equipment designed primarily for indoor use.

No.	Symbol mark	Approved standards	Description
8		IEC60417 No. 5926	Polarity of d.c. power connector To identify the positive and negative connections (the polarity) on a piece of equipment to which a d.c. power supply may be connected.
9		—	The same as No. 8.
10		IEC60417 No. 5001B	Battery, general On battery powered equipment. To identify a device for instance a cover for the battery compartment, or the connector terminals.
11		IEC60417 No. 5002	Positioning of cell To identify the battery holder itself and to identify the positioning of the cell(s) inside the battery holder.
12		—	The same as No. 11.
13		IEC60417 No. 5019	Protective earth To identify any terminal which is intended for connection to an external conductor for protection against electric shock in case of a fault, or the terminal of a protective earth electrode.
14		IEC60417 No. 5017	Earth To identify an earth (ground) terminal in cases where neither the symbol No. 13 is explicitly required.

No.	Symbol mark	Approved standards	Description
15		IEC60417 No. 5032	Alternating current To indicate on the rating plate that the equipment is suitable for alternating current only; to identify relevant terminals.
16		IEC60417 No. 5031	Direct current To indicate on the rating plate that the equipment is suitable for direct current only; to identify relevant terminals.
17		IEC60417 No. 5172	Class II equipment To identify equipment meeting the safety requirements specified for Class II equipment according to IEC 61140.
18		ISO 3864	General prohibition To identify actions or operations that are prohibited.
19		ISO 3864	Contact prohibition To indicate injury that could occur due to touching a specific part of the equipment.
20		—	Never look into the optical lens while the projector is on.
21		—	To indicate that the marked item don't place anything on projector.
22		ISO3864 IEC60825-1	Caution, laser radiation To indicate the equipment has a laser radiation part.

No.	Symbol mark	Approved standards	Description
23		ISO 3864	Disassembly prohibition To indicate a risk of injury, such as electric shock, if the equipment is disassembled.
24		IEC60417 No. 5266	Standby, partial standby To indicate that part of the equipment is in the ready status.
25		ISO3864 IEC60417 No. 5057	Caution, movable parts To indicate that you must keep away from movable parts according to protection standards.
26		IEC60417 No. 6056	Caution (Moving Fan Blades) As a safety precaution, stay away from the moving fan blades.
27		IEC60417 No. 6043	Caution (Sharp Corners) To indicate sharp corners that should not be touched.
28		—	To indicate that looking into the lens while projecting is prohibited.
29		ISO7010 No. W027 ISO 3864	Warning, Optical radiation (such as UV, visible radiation, IR) Taking care to avoid injury to eyes and skin when in the vicinity of optical radiation.
30		IEC60417 No. 5109	Not to be used in residential areas. To identify electrical equipment which is not suitable for a residential area.

This product is a laser projector that projects images onto surfaces such as walls and screens.

This projector is a Class 1 consumer laser product that complies with the following standards:

- IEC60825-1:2014
- EN60825-1:2014+A11:2021
- EN50689:2021

Follow these safety instructions when using the projector.

Warning

- Do not open the projector's case. The projector contains a high-powered laser.
- Possibly hazardous optical radiation emitted from this product. Do not look at operating light source. Eye injury may result.
- As with any bright source, do not stare into the beam, RG2 IEC/EN 62471-5:2015.

Caution

Do not disassemble the projector when disposing of it. Dispose according to your local or national laws and regulations.



The projector uses a laser as the light source. The laser has the following characteristics.

- Depending on the surroundings, the brightness of the light source may decline. The brightness declines a lot when the temperature gets too high.
- The brightness of the light source declines the longer it is used. You can change the relationship between usage time and decline in brightness settings.

▶▶ Related Links

- "Laser Warning Labels" [p.102](#)

Laser Warning Labels

Laser warning labels are attached on the projector.

Inside



Side

EF-21

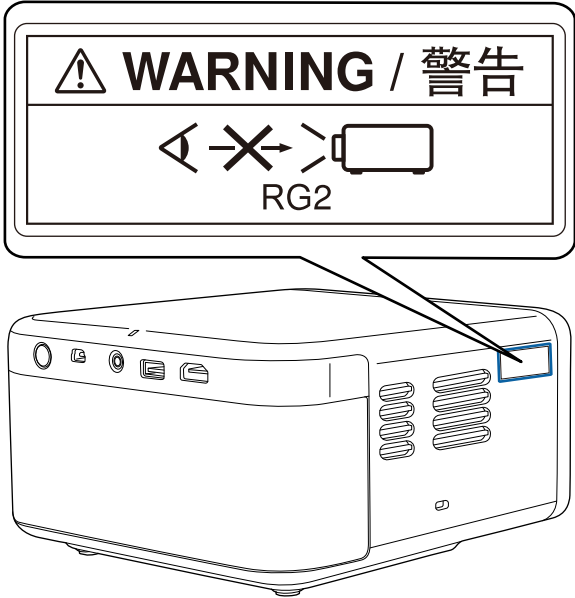

EF-22

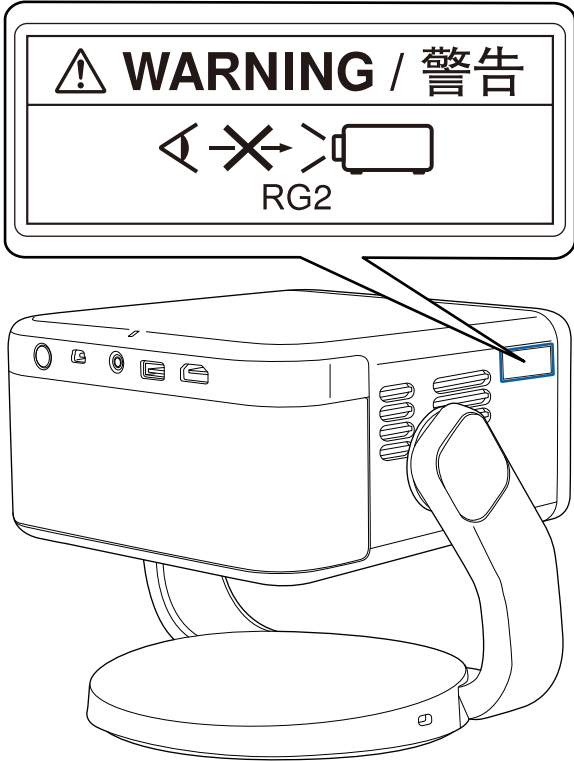

Warning

- Never look into the projector lens when the laser is on. This can damage your eyes and is especially dangerous for children and pets.
- When turning on the projector at a distance using the remote control, make sure no one is looking into the lens.
- Do not allow small children to operate the projector. Children must be accompanied by an adult.
- Do not look into the lens during projection. Also, do not look into the lens using optical devices, such as a magnifying glass or telescope. This could cause visual impairment.
- If any problems occur with the projector, unplug the projector from the outlet and contact Epson for help. Continuing to use it as it is may result in fire or accidents, and can also damage your eyes.

Bottom

EF-21

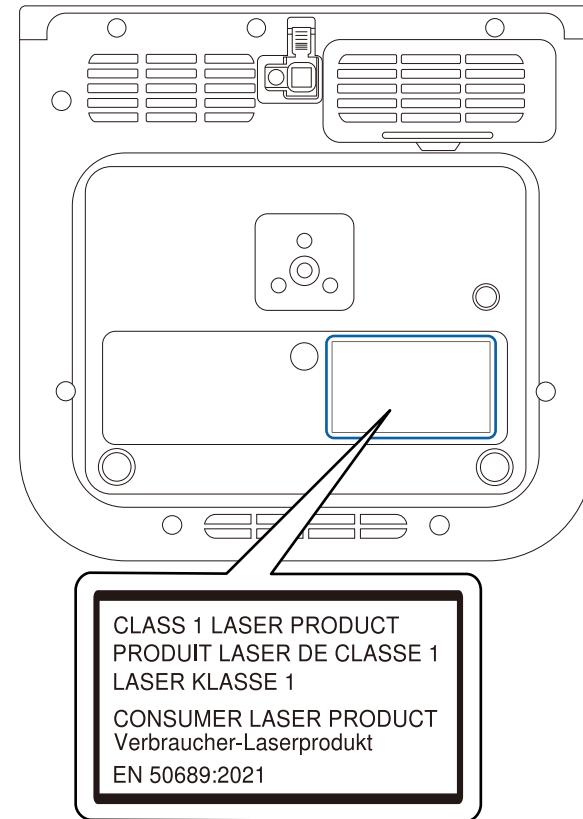

EF-22

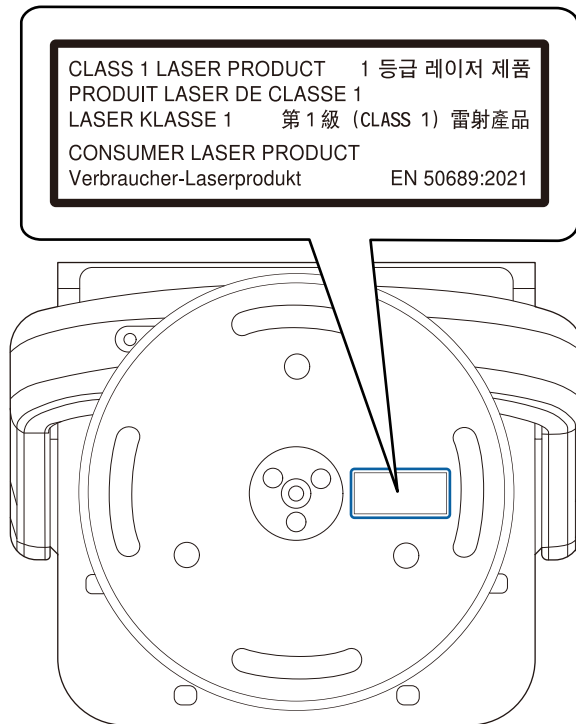

For North/South America

Complies with FDA performance standards for laser products except for conformance as a Risk Group 2 LIP as defined in IEC 62471-5: Ed. 1.0. For more information see Laser Notice No. 57, dated May 8, 2019.

This section briefly explains the difficult terms that are not explained in the text of this guide. For details, refer to other commercially available publications.

Aspect Ratio	The ratio between an image's length and its height. Screens with a horizontal:vertical ratio of 16:9, such as HDTV screens, are known as wide screens. SDTV and general computer displays have an aspect ratio of 4:3.
Contrast	The relative brightness of the light and dark areas of an image can be increased or decreased to make text and graphics stand out more clearly, or to make them appear softer. Adjusting this particular property of an image is called contrast adjustment.
Full HD	A screen size standard with a resolution of 1,920 (horizontal) × 1,080 (vertical) dots.
HDCP	HDCP is an abbreviation for High-bandwidth Digital Content Protection. It is used to prevent illegal copying and protect copyrights by encrypting digital signals sent over DVI and HDMI ports. Because the HDMI port on this projector supports HDCP, it can project digital images protected by HDCP technology. However, the projector may not be able to project images protected with updated or revised versions of HDCP encryption.
HDMI™	An abbreviation for High Definition Multimedia Interface. HDMI™ is a standard aimed at digital consumer electronics and computers. This is the standard by which HD images and multichannel audio signals are digitally transmitted. By not compressing the digital signal, the image can be transferred at the highest quality possible. It also provides an encryption function for the digital signal.
HDTV	An abbreviation for High-Definition Television that refers to high-definition systems which satisfy the following conditions: <ul style="list-style-type: none"> • Vertical resolution of 720p or 1080i or greater (p = Progressive, i = Interlace) • Screen aspect ratio of 16:9

Pairing	Register devices in advance when connecting with Bluetooth devices to ensure mutual communication.
Refresh Rate	The light-emitting element of a display maintains the same luminosity and color for an extremely short time. Because of this, the image must be scanned many times per second to refresh the light-emitting element. The number of refresh operations per second is called the Refresh rate and is expressed in hertz (Hz).
SDTV	An abbreviation for Standard Definition Television that refers to standard television systems which do not satisfy the conditions for HDTV High-Definition Television.

Check these sections for important notices about your projector.

► **Related Links**

- "FCC Compliance Statement" [p.107](#)
- "Indication of the manufacturer and the importer in accordance with requirements of EU directive" [p.108](#)
- "Indication of the manufacturer and the importer in accordance with requirements of United Kingdom directive" [p.108](#)
- "Restriction of Use" [p.108](#)
- "Trademarks" [p.109](#)
- "Copyright Notice" [p.109](#)
- "Copyright Attribution" [p.109](#)

FCC Compliance Statement

Supplier's DECLARATION of CONFORMITY

According to 47CFR, Part 2 and 15

Class B Personal Computers and Peripherals; and/or

CPU Boards and Power Supplies used with Class B Personal Computers

We: Epson America, Inc.

Located at: 3131 Katella Avenue, Los Alamitos, CA

Tel: 562-981-3840

Declare under sole responsibility that the product identified herein, complies with 47CFR Part 2 and 15 of the FCC rules as a Class B digital device. Each product marketed, is identical to the representative unit tested and found to be compliant with the standards. Records maintained continue to reflect the equipment being produced can be expected to be within the variation accepted, due to quantity production and testing on a statistical basis as required by 47CFR 2.906. Operation is subject to the following two conditions: (1) this device may not cause harmful interference, and (2) this device must accept any interference received, including interference that may cause undesired operation.

Trade Name: EPSON

Type of Product: LCD Projector

Model: HB35A (EF-21)

Model: HB38A (EF-22)

Supplier's DECLARATION of CONFORMITY

According to 47CFR, Part 2 and 15

Class B external switching power supplies

We: Epson America, Inc.

Located at: 3131 Katella Avenue, Los Alamitos, CA

Tel: 562-981-3840

Declare under sole responsibility that the product identified herein, complies with 47CFR Part 2 and 15 of the FCC rules as a Class B digital device. Each product marketed, is identical to the representative unit tested and found to be compliant with the standards. Records maintained continue to reflect the equipment being produced can be expected to be within the variation accepted, due to quantity production and testing on a statistical basis as required by 47CFR 2.906. Operation is subject to the following two conditions: (1) this device may not cause harmful interference, and (2) this device must accept any interface received, including interference that may cause undesired operation.

Trade Name: EPSON

Type of Product: AC Adapter

Model: AD10370LF

FCC Compliance Statement For United States Users

This device complies with part 15 of the FCC Rules. Operation is subject to the following two conditions: (1) This device may not cause harmful interference, and (2) this device must accept any interference received, including interference that may cause undesired operation.

This equipment has been tested and found to comply with the limits for a Class B digital device, pursuant to Part 15 of the FCC Rules. These limits are designed to provide reasonable protection against harmful interference in a residential

installation. This equipment generates, uses, and can radiate radio frequency energy and, if not installed and used in accordance with the instructions, may cause harmful interference to radio communications. However, there is no guarantee that interference will not occur in a particular installation. If this equipment does cause interference to radio and television reception, which can be determined by turning the equipment off and on, the user is encouraged to try to correct the interference by one or more of the following measures.

- Reorient or relocate the receiving antenna.
- Increase the separation between the equipment and receiver.
- Connect the equipment into an outlet on a circuit different from that to which the receiver is connected.
- Consult the dealer or an experienced radio/TV technician for help.

WARNING

The connection of a non-shielded equipment interface cable to this equipment will invalidate the FCC Certification or Declaration of this device and may cause interference levels which exceed the limits established by the FCC for this equipment. It is the responsibility of the user to obtain and use a shielded equipment interface cable with this device. If this equipment has more than one interface connector, do not leave cables connected to unused interfaces. Changes or modifications not expressly approved by the manufacturer could void the user's authority to operate the equipment.

Indication of the manufacturer and the importer in accordance with requirements of EU directive

Manufacturer: SEIKO EPSON CORPORATION
Address: 3-5, Owa 3-chome, Suwa-shi, Nagano-ken 392-8502 Japan
<http://www.epson.com/>

Importer: EPSON EUROPE B.V.
Address: Atlas Arena, Asia Building, Hoogoorddreef 5,1101 BA Amsterdam Zuidoost
The Netherlands
<http://www.epson.eu/>

Indication of the manufacturer and the importer in accordance with requirements of United Kingdom directive

Manufacturer: SEIKO EPSON CORPORATION
Address: 3-5, Owa 3-chome, Suwa-shi, Nagano-ken 392-8502 Japan
<http://www.epson.com/>

Importer: Epson (UK) Ltd.
Address: Westside, London Road, Hemel Hempstead, Hertfordshire, HP3 9TD,
United Kingdom
<http://www.epson.co.uk>

Restriction of Use

When this product is used for applications requiring high reliability/safety such as transportation devices related to aviation, rail, marine, automotive etc.; disaster prevention devices; various safety devices etc; or functional/precision devices etc, you should use this product only after giving consideration to including fail-safes and redundancies into your design to maintain safety and total system reliability. Because this product was not intended for use in applications requiring extremely high reliability/safety such as aerospace equipment, main communication equipment, nuclear power control equipment, or medical equipment related to direct medical care etc, please make your own judgment on this product's suitability after a full evaluation.

Trademarks

Mac, OS X, and macOS are trademarks of Apple Inc.

Microsoft, Windows, and the Windows logo are trademarks or registered trademarks of Microsoft Corporation in the United States and/or other countries.

Google TV is the name of this device's software experience and a trademark of Google LLC. Google, YouTube and Google Cast are trademarks of Google LLC.

Netflix is a registered trademark of Netflix, Inc. **NETFLIX**

Dolby and the double-D symbol are registered trademarks of Dolby Laboratories Licensing Corporation. Manufactured under license from Dolby Laboratories.

The terms HDMI, HDMI High-Definition Multimedia Interface, HDMI Trade dress and the HDMI Logos are trademarks or registered trademarks of HDMI Licensing Administrator, Inc. 

Wi-Fi[®] is a trademark of the Wi-Fi Alliance[®].

The Bluetooth[®] word mark and logos are registered trademarks owned by Bluetooth SIG, Inc. and any use of such marks by Seiko Epson Corporation is under license. Other trademarks and trade names are those of their respective owners.

Adobe and Adobe Reader are either registered trademarks or trademarks of Adobe Systems Incorporated in the United States and/or other countries.

Other product names used herein are also for identification purposes only and may be trademarks of their respective owners. Epson disclaims any and all rights in those marks.

Copyright Notice

All rights reserved. No part of this publication may be reproduced, stored in a retrieval system, or transmitted in any form or by any means, electronic, mechanical, photocopying, recording, or otherwise, without the prior written

permission of Seiko Epson Corporation. No patent liability is assumed with respect to the use of the information contained herein. Neither is any liability assumed for damages resulting from the use of the information contained herein.

Neither Seiko Epson Corporation nor its affiliates shall be liable to the purchaser of this product or third parties for damages, losses, costs, or expenses incurred by the purchaser or third parties as a result of: accident, misuse, or abuse of this product or unauthorized modifications, repairs, or alterations to this product, or (excluding the U.S.) failure to strictly comply with Seiko Epson Corporation's operating and maintenance instructions.

Seiko Epson Corporation shall not be liable against any damages or problems arising from the use of any options or any consumable products other than those designated as Original Epson Products or Epson Approved Products by Seiko Epson Corporation.

The contents of this guide may be changed or updated without further notice.

Copyright Attribution

This information is subject to change without notice.

© 2024 Seiko Epson Corporation

2024.10 414532001EN